

Safety relays monostable

OA 5601, OA 5602, OA 5603

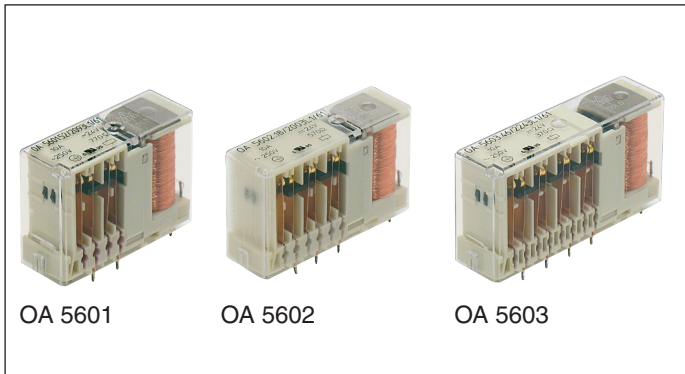

- Acc. to DIN EN 50205, DIN EN 61810-1, DIN EN 60664-1
- With forcibly guided contacts
- Clearance and creepage distances, contact-coil ≥ 8 mm
- High voltage resistance ≥ 4 kV
- High switching reliability due to crown contacts
- Small height 39.5 mm
- High temperature range
at OA 5601 and OA 5602: $-40 \dots +85^\circ\text{C}$
at OA 5603: $-40 \dots +75^\circ\text{C}$
- High continuous thermal current $I_{th} = 10$ A
- Mechanical life $> 30 \times 10^6$ switching cycles
- High voltage range $0.7 \dots 1.6 U_N$
- **Double and reinforced insulation with contamination level 2 according to EN 50178** Overvoltage category: III
- Optionally wash proof

Application

- To be used in circuits for safety applications
- Escalators and walkways
- Elevators for men and load
- Railway technology
- Medical technology

Approvals and Markings



Technical Data

Relay type		OA 5601	OA 5602	OA 5603
1.0 Coil				
1.1 Nominal voltage	DC V	6, 12, 24, 48, 60, 110 or others on request		
1.2 Nominal consumption	W	0.75	1	1.25 ¹⁾
1.11 Voltage range	U_N	0.7 ... 1.6	0.7 ... 1.6	0.7 ... 1.6
1.3 Holding power (at $0.5 \times U_N$)		0.19	0.25	0.32
2.0 Contacts				
2.1 Contact arrangement		2 NO / 2 NC 3 NO / 1 NC	2 NO / 4 NC 3 NO / 3 NC 4 NO / 2 NC	7 NO / 1 NC : 2 NO / 6 NC
2.2 Contact material		AgSnO ₂ + 0.2 μm Au; AgNi + 0.2 μm Au, AgNi + 5 μm Au		
2.3 Rated insulation voltage	AC V	250		
Switching voltage min./max.	V	AC/DC 10 / DC 250, AC 400 (AC/DC 2 V / AC/DC 60 V) ²⁾		
2.4 Limiting continuous current I_{th} max.	A	6 x 10 (see operating voltage limit curve)		
Switching current min./max.	A	10 mA ⁴⁾ / 10 A (2 mA / 0.3 A) ²⁾		
2.5 Switching power min./max.	VA	0,1 / 2500 (10 mVA / 12 VA) ²⁾		
Switching power min./max.	W	0.1 ⁴⁾ ... 240 (10 mW / 12 W) ²⁾ (see limit curve for arc-free operation)		
2.6 Switching capacity				
to IEC/EN 60947-5-1 AC 15 ⁵⁾	AC V/A		NO: 250 / 3 NC: 250 / 2	
to IEC/EN 60947-5-1 AC 15 ⁶⁾	AC V/A		NO: 250 / 5 NC: 250 / 2	
to IEC/EN 60947-5-1 DC 13 ⁵⁾	DC V/A		NO: 24 / 2 NC: 24 / 2	
at 0.1 Hz DC 13 ⁵⁾	DC V/A		NO: 24 / 6 NC: 24 / 6	
to UL 508			A300	
2.7 Electrical life			at 1 s ON, 1 s OFF (see contacts service life)	
at AC 230 V, 5 A, $\cos\phi = 1$	switching cycles		$> 7 \times 10^5$, AgSnO ₂ / $> 5 \times 10^5$, AgNi10	
at AC 230 V, 10 A, $\cos\phi = 1$	switching cycles		$> 3 \times 10^5$, AgSnO ₂ / $> 2 \times 10^5$, AgNi10	
2.8 Switching frequency max.	switching cycles/s		10	
2.9 Response time / Release time	ms		typically 27 / typically 5	
2.10 Contact force	cN		≥ 14	
2.14 Contact gap	mm		> 1 (normal operation) / $> 0.5^3)$	
3.0 Other				
3.1 Mechanical life	switching cycles		$> 30 \times 10^6$	
3.2 Temperature range	$^\circ\text{C}$	- 40 ... + 85	- 40 ... + 85	- 40 ... + 75
3.3 Degree of protection		Solder line proof RT II as option wash proof RT III		
3.5 Vibration resistance		10 ... 55 Hz, 0.35 mm Ampl.; 5 g max. IEC/EN 60068-2-6		
3.6 Climate resistance		25 / 085 / 04 (climate category); A / B / D IEC/EN 60068-1		
3.7 Short circuit strength 1 kA / AC 250 V	AgSnO ₂ AgNi		NO: 10 A gL / NC: 10 A gL NO: 10 A gL / NC: 6 A gL	EN 60947-5-1 EN 60947-5-1

¹⁾ For OA 5603.46 (2 NO / 6 NC) and OA 5603.56 (3 NO / 5 NC) nominal consumption is 1.65 W

²⁾ Values for AgNi10-Contacts + 5 μm Au

³⁾ over entire service life, even when under fault and at $1.6 U_N$

⁴⁾ Typical values for AgSnO₂ and AgNi

⁵⁾ Values for AgNi-Contacts

⁶⁾ Values for AgSnO₂-Contacts

Technical Data

3.8	Insulation acc. to IEC 60664-1, EN 50178			
	Rated insulation voltage	AC V		250
	Pollution degree			3 / 2 (double and reinforced insulation)
	Overtoltage category			III
	Test voltage			
	Contact- Coil (1 min)	AC kV eff.		≥ 4
	Contact-Contact (1min)	AC kV eff.		≥ 4
	Open contact acc. to DIN EN 61810-1	AC kV eff.		1.5
	Transient voltage			
	Contact- Coil (1,2 - 50 μs)	kV		≥ 6
	Clearance and creepage distances			
	Contact- Coil	mm		≥ 8
	Contact-Contact	mm		≥ 5.5
3.9	Weight	g	approx. 78	approx. 85 approx. 95
4.0 Packing				
4.1	on cardboard in slipcase	piece	20	15 15
4.2	in case package	piece	100	75 75
5.0 Solder method				
5.1	Solder method /-temperature /-duration	°C / s		Wafer soldering / 260 / 5

Design versions

U _N (DCV)	Voltage range (DC V)	OA 5601				OA 5602				OA 5603							
		R _{Coil} Ω±10%	.52 2 NO, 2 NC	.48 3 NO, 1 NC	R _{Coil} Ω±10%	.18 3 NO, 3 NC	.50 2 NO, 4 NC	.54 4 NO, 2 NC	R _{Coil} Ω±10%	.63 7 NO, 1 NC	.59 6 NO, 2 NC	.58 5 NO, 3 NC	.57 4 NO, 4 NC	R _{Coil} Ω±10%	.56 3 NO, 5 NC	.46 2 NO, 6 NC	

AgSnO₂-Contacts + 0.2 μm Au

6	4,2 ... 9,6	48	2091	2121	35	2001	2031	2061	29	2151	2181	2271	2211	21	2301	2241
12	8,4 ... 19,2	192	2092	2122	140	2002	2032	2062	112	2152	2182	2272	2212	88	2302	2242
24	16,8 ... 38,4	770	2093	2123	570	2003	2033	2063	460	2153	2183	2273	2213	370	2303	2243
48	33,6 ... 76,8	2880	2094	2124	2300	2004	2034	2064	1800	2154	2184	2274	2214	1400	2304	2244
60	42,0 ... 96,0	4800	2095	2125	3600	2005	2035	2065	2880	2155	2185	2275	2215	2230	2305	2245
110	77,0 ... 176,0	16000	2096	2126	12100	2006	2036	2066	9500	2156	2186	2276	2216	7150	2306	2246

AgNi 10-Contacts + 0.2 μm Au

6	4,2 ... 9,6	48	2101	2131	35	2011	2041	2071	29	2161	2191	2281	2221	21	2311	2251
12	8,4 ... 19,2	192	2102	2132	140	2012	2042	2072	112	2162	2192	2282	2222	88	2312	2252
24	16,8 ... 38,4	770	2103	2133	570	2013	2043	2073	460	2163	2193	2283	2223	370	2313	2253
48	33,6 ... 76,8	2880	2104	2134	2300	2014	2044	2074	1800	2164	2194	2284	2224	1400	2314	2254
60	42,0 ... 96,0	4800	2105	2135	3600	2015	2045	2075	2880	2165	2195	2285	2225	2230	2315	2255
110	77,0 ... 176,0	16000	2106	2136	12100	2016	2046	2076	9500	2166	2196	2286	2226	7150	2316	2256

AgNi 10-Contacts + 5 μm Au

6	4,2 ... 9,6	48	2111	2141	35	2021	2051	2081	29	2171	2201	2291	2231	21	2321	2261
12	8,4 ... 19,2	192	2112	2142	140	2022	2052	2082	112	2172	2202	2292	2232	88	2322	2262
24	16,8 ... 38,4	770	2113	2143	570	2023	2053	2083	460	2173	2203	2293	2233	370	2323	2263
48	33,6 ... 76,8	2880	2114	2144	2300	2024	2054	2084	1800	2174	2204	2294	2234	1400	2324	2264
60	42,0 ... 96,0	4800	2115	2145	3600	2025	2055	2085	2880	2175	2205	2295	2235	2230	2325	2265
110	77,0 ... 176,0	16000	2116	2146	12100	2026	2056	2086	9500	2176	2206	2296	2236	7150	2326	2266

Ordering example

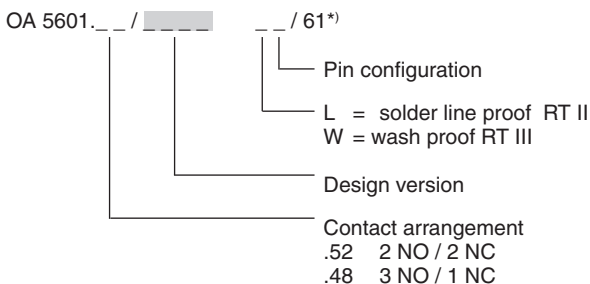

*) / 61 cURus approval

Characteristics

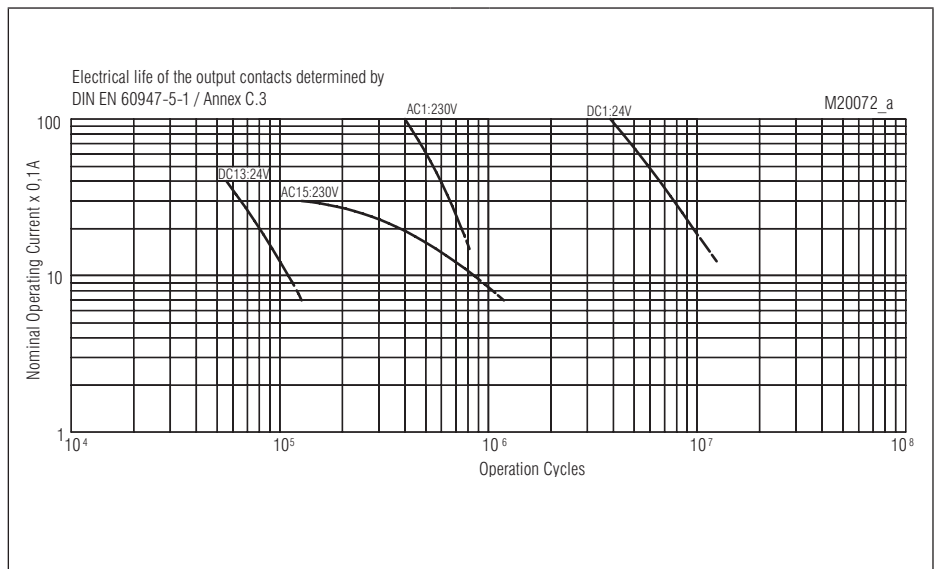
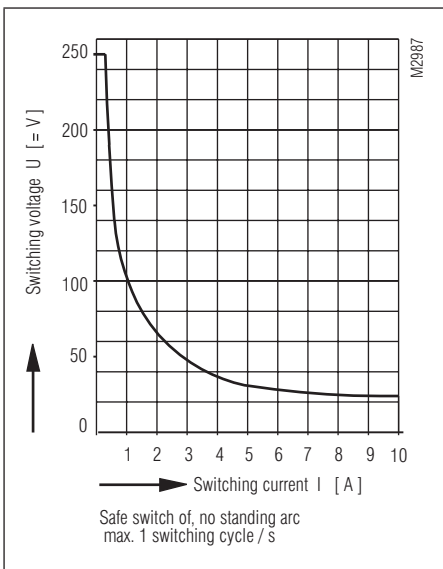
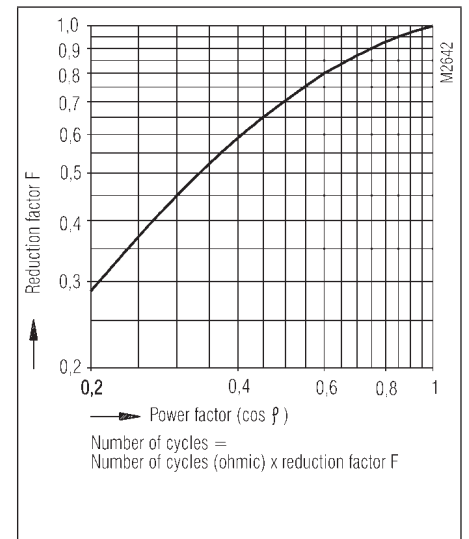
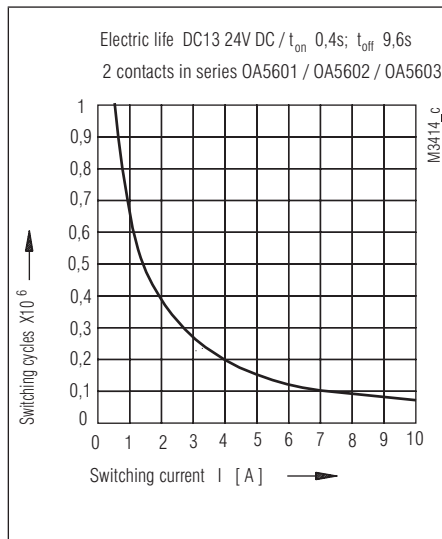
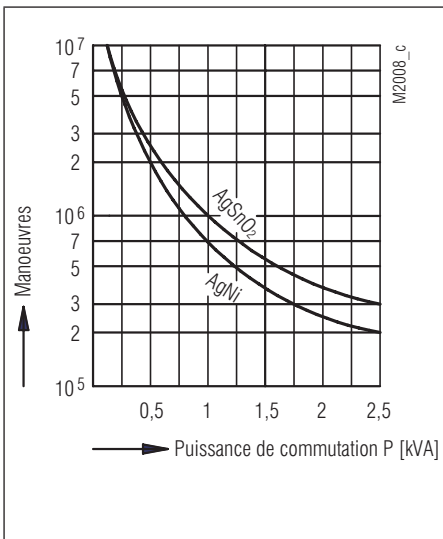
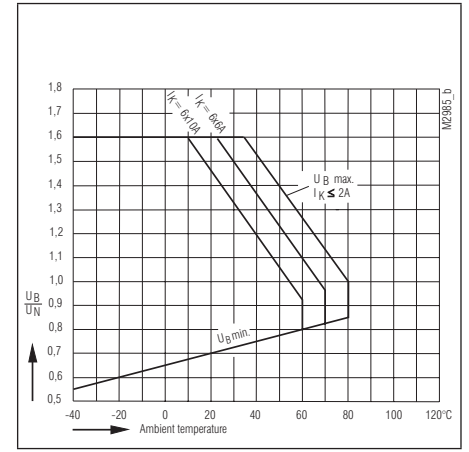
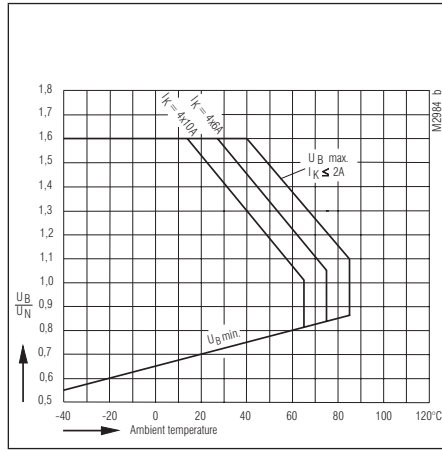
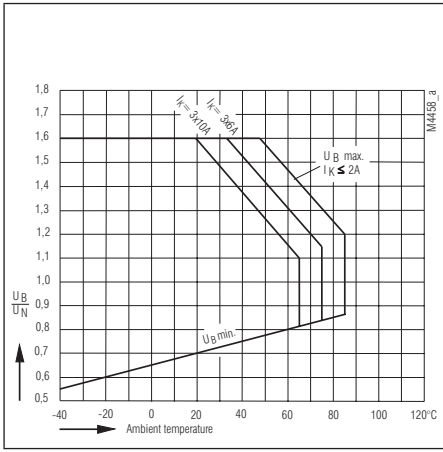

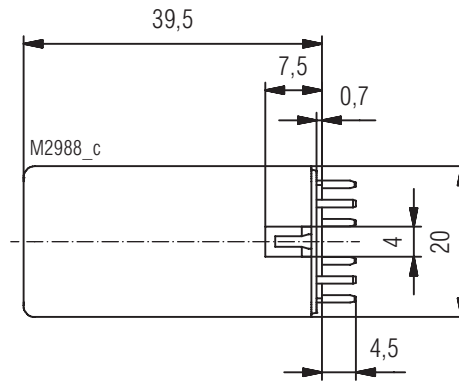
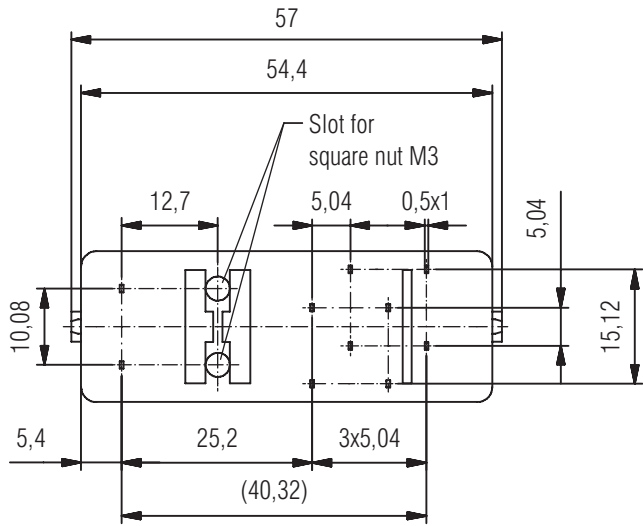

Drilling plan (solder side)

Pin arrangement OA5601.48 3NO/1NC

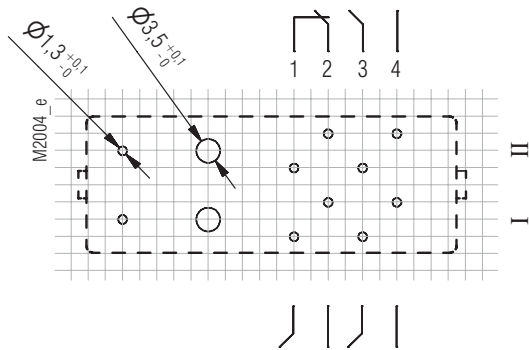

Pin arrangement OA5601.52 2NO/2NC

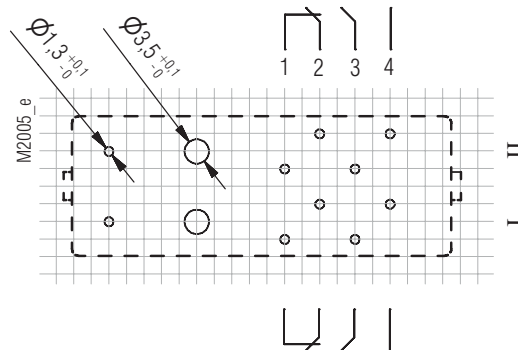

Connection for basic grid dimensions 2.5 mm as well as 2.54 mm according to IEC/EN 60097 and IEC 60326 average

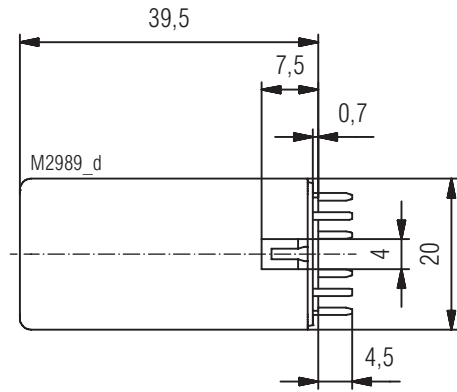
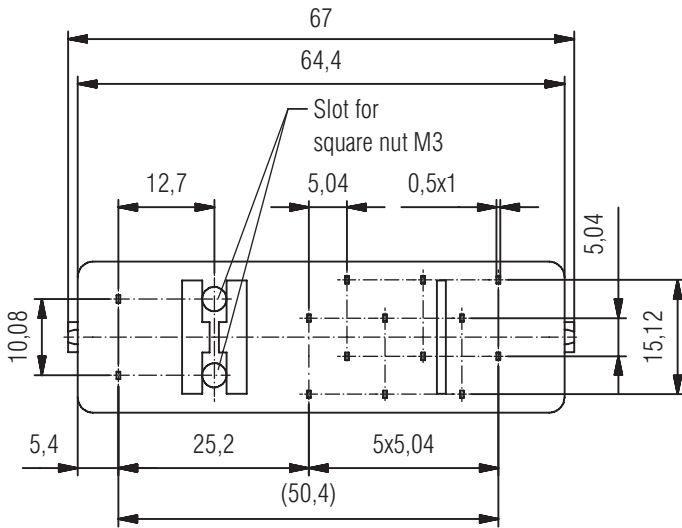

Drilling plan (solder side)

Pin arrangement OA5602.18 3NO/3NC

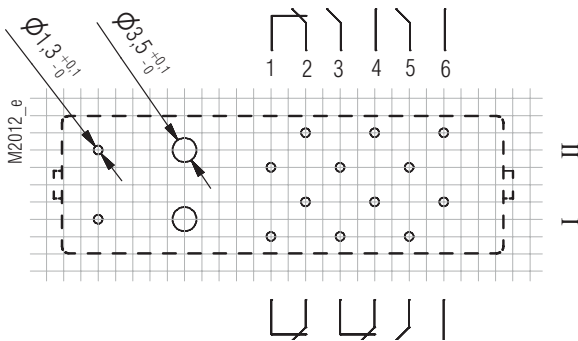

Pin arrangement OA5602.50 2NO/4NC

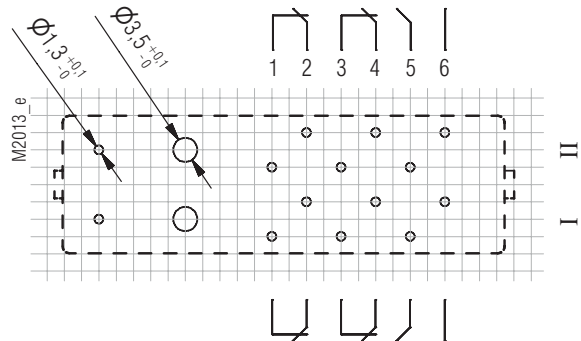

Pin arrangement OA5602.54 4NO/2NC

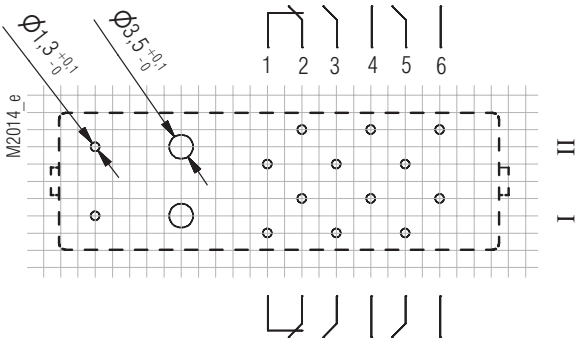

Pin arrangement OA5602.60 5NO/1NC

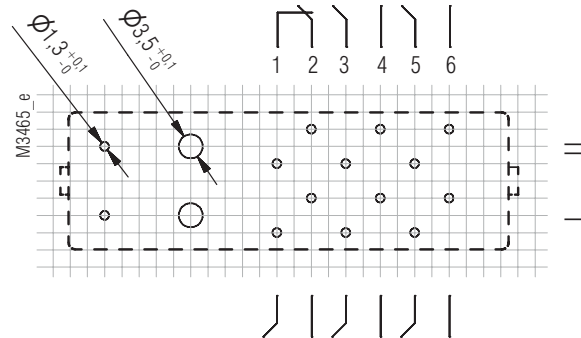

Connection for basic grid dimensions 2.5 mm as well as 2.54 mm according to IEC/EN 60097 and IEC 60326 average

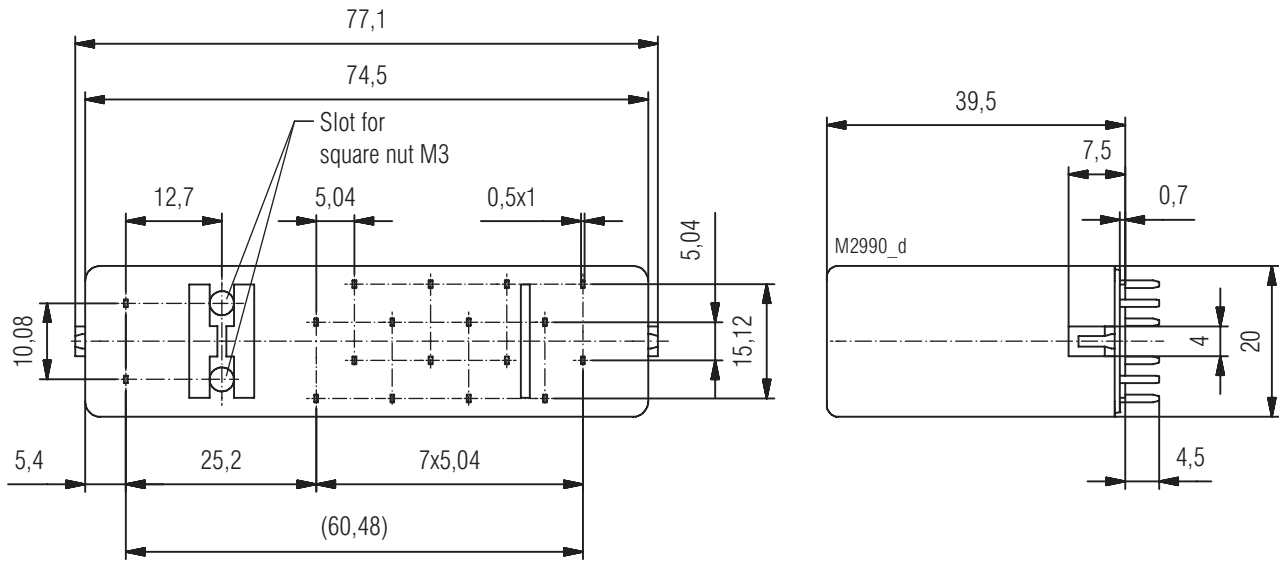

Drilling plan (solder side)

Pin arrangement OA5603.63 7NO/1NC

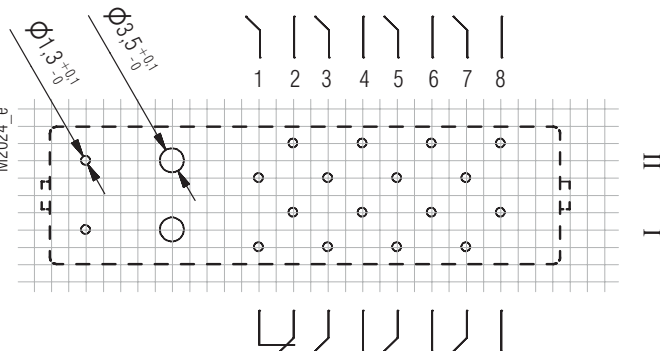

Pin arrangement OA5603.59 6NO/2NC

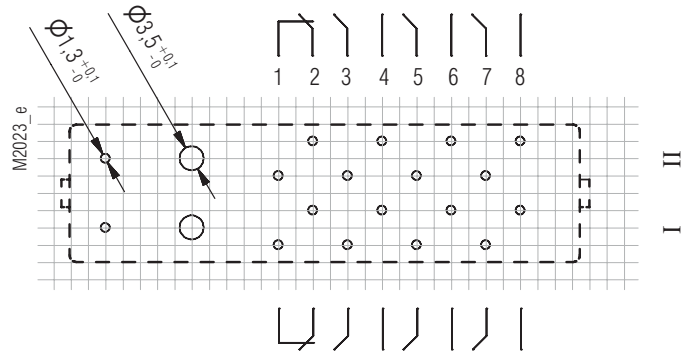

Pin arrangement OA5603.58 5NO/3NC

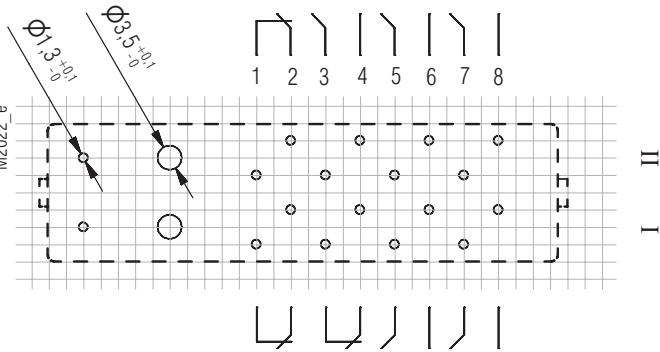

Pin arrangement OA5603.57 4NO/4NC

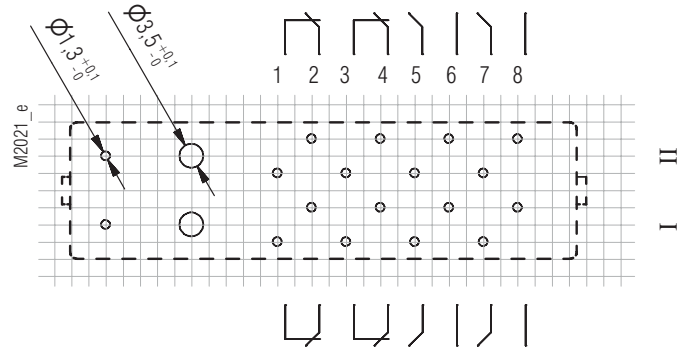

Connection for basic grid dimensions 2.5 mm as well as 2.54 mm according to IEC/EN 60097 and IEC 60326 average

Drilling plan (solder side)

Pin arrangement OA5603.56 3NO/5NC

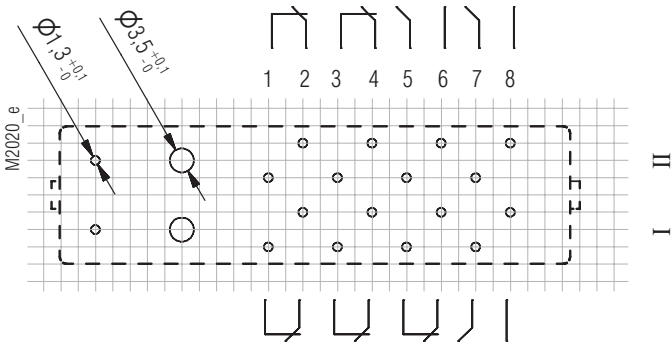

Pin arrangement OA5603.46 2NO/6NC

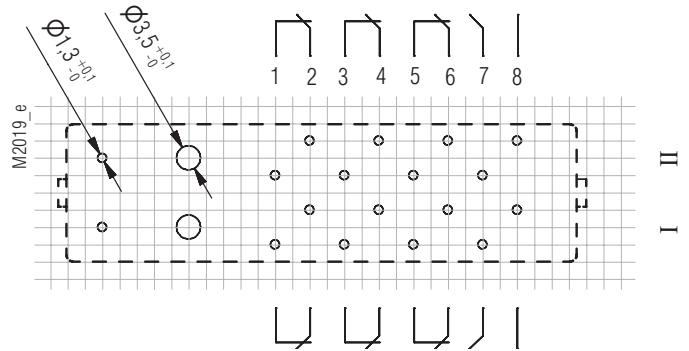

Connection for basic grid dimensions 2.5 mm as well as 2.54 mm according to IEC/EN 60097 and IEC 60326 average

Notes

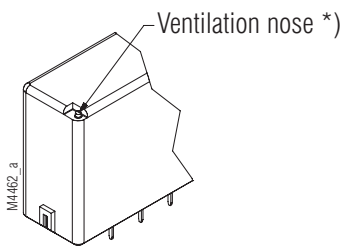

*) When using the maximum switching capacity it is recommended to open the relay at the indicated position.

Socket ET 1415.011

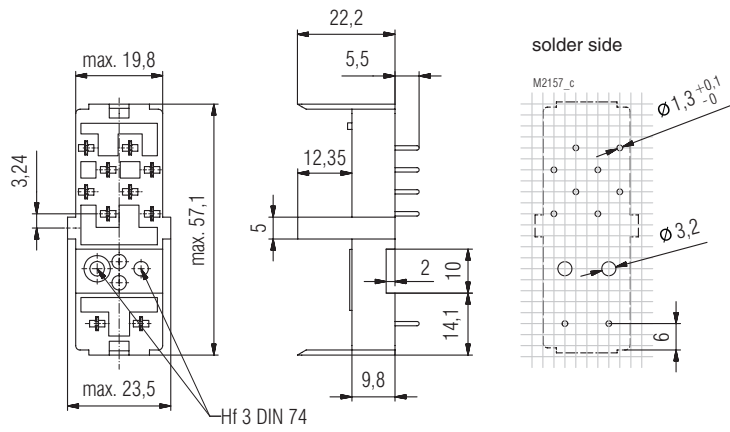

Article number: 0041069

Socket ET 1415.012

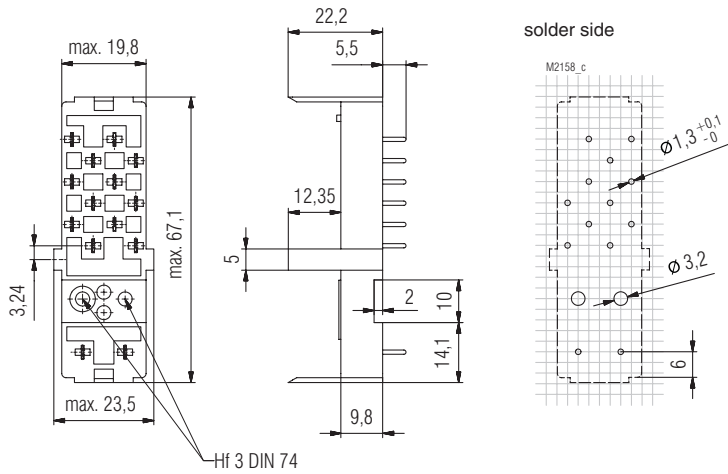

Article number: 0041065

Socket ET 1415.013

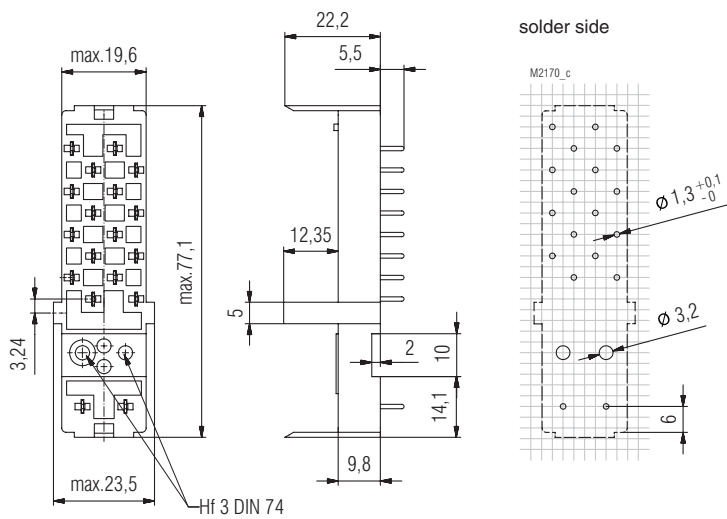

Article number: 0041070