

Documentation

## EK9300

PROFINET-Bus Coupler for EtherCAT Terminals

Version: 3.2.3  
Date: 2018-10-09

**BECKHOFF**



# Table of contents

<b>1</b>	<b>Foreword</b> .....	<b>5</b>
1.1	Notes on the documentation .....	5
1.2	Safety instructions .....	6
1.3	Documentation issue status .....	7
1.4	Version identification of EtherCAT devices .....	7
<b>2</b>	<b>Product overview</b> .....	<b>12</b>
2.1	EKxxxx - System overview .....	12
2.2	Technical data .....	13
2.3	Technical data PROFINET .....	14
<b>3</b>	<b>Mounting and wiring</b> .....	<b>15</b>
3.1	Mounting .....	15
3.1.1	Instructions for ESD protection .....	15
3.1.2	Dimensions .....	16
3.1.3	Installation on mounting rails – Bus Coupler .....	16
3.2	Wiring .....	18
3.2.1	Power supply .....	18
3.2.2	Ethernet .....	20
3.2.3	ATEX - Special conditions (standard temperature range) .....	24
3.2.4	ATEX Documentation .....	24
3.2.5	UL notice .....	25
<b>4</b>	<b>Parameterization and commissioning</b> .....	<b>26</b>
4.1	Meaning of the DIP switch .....	26
4.2	Further interfaces .....	26
4.3	Setting the IP address .....	27
<b>5</b>	<b>Configuration</b> .....	<b>28</b>
5.1	EK9300 configuration .....	28
5.2	EK9300 EtherCAT configuration .....	30
5.3	EK9300 – Configuration example .....	34
5.4	From firmware Version 6 .....	36
5.4.1	EK9300 - CoE data access over PROFINET .....	36
5.4.2	EK9300 - multi-configuration mode .....	38
5.4.3	EK9300 - IO-LINK .....	40
5.5	From firmware version 8 .....	43
5.5.1	EBus Error Behaviour .....	43
<b>6</b>	<b>Ethernet</b> .....	<b>46</b>
6.1	PROFINET system presentation .....	46
<b>7</b>	<b>Error handling and diagnosis</b> .....	<b>48</b>
7.1	Diagnostic LEDs .....	48
<b>8</b>	<b>Appendix</b> .....	<b>50</b>
8.1	Update Bus Coupler image .....	50
8.2	EK9300 – FAQ .....	51
8.3	List of Abbreviations .....	51

---

8.4 Support and Service ..... 54

# 1 Foreword

## 1.1 Notes on the documentation

### Intended audience

This description is only intended for the use of trained specialists in control and automation engineering who are familiar with the applicable national standards.

It is essential that the documentation and the following notes and explanations are followed when installing and commissioning these components.

It is the duty of the technical personnel to use the documentation published at the respective time of each installation and commissioning.

The responsible staff must ensure that the application or use of the products described satisfy all the requirements for safety, including all the relevant laws, regulations, guidelines and standards.

### Disclaimer

The documentation has been prepared with care. The products described are, however, constantly under development.

We reserve the right to revise and change the documentation at any time and without prior announcement.

No claims for the modification of products that have already been supplied may be made on the basis of the data, diagrams and descriptions in this documentation.

### Trademarks

Beckhoff®, TwinCAT®, EtherCAT®, EtherCAT P®, Safety over EtherCAT®, TwinSAFE®, XFC® and XTS® are registered trademarks of and licensed by Beckhoff Automation GmbH.

Other designations used in this publication may be trademarks whose use by third parties for their own purposes could violate the rights of the owners.

### Patent Pending

The EtherCAT Technology is covered, including but not limited to the following patent applications and patents: EP1590927, EP1789857, DE102004044764, DE102007017835 with corresponding applications or registrations in various other countries.

The TwinCAT Technology is covered, including but not limited to the following patent applications and patents: EP0851348, US6167425 with corresponding applications or registrations in various other countries.

The logo for EtherCAT, featuring the word "EtherCAT" in a bold, black, sans-serif font. A red arrow points from the top of the "A" towards the right, ending above the "T". A registered trademark symbol (®) is located to the right of the "T".

EtherCAT® is registered trademark and patented technology, licensed by Beckhoff Automation GmbH, Germany

### Copyright

© Beckhoff Automation GmbH & Co. KG, Germany.

The reproduction, distribution and utilization of this document as well as the communication of its contents to others without express authorization are prohibited.

Offenders will be held liable for the payment of damages. All rights reserved in the event of the grant of a patent, utility model or design.

## 1.2 Safety instructions

### Safety regulations

Please note the following safety instructions and explanations!  
Product-specific safety instructions can be found on following pages or in the areas mounting, wiring, commissioning etc.

### Exclusion of liability

All the components are supplied in particular hardware and software configurations appropriate for the application. Modifications to hardware or software configurations other than those described in the documentation are not permitted, and nullify the liability of Beckhoff Automation GmbH & Co. KG.

### Personnel qualification

This description is only intended for trained specialists in control, automation and drive engineering who are familiar with the applicable national standards.

### Description of instructions

In this documentation the following instructions are used.  
These instructions must be read carefully and followed without fail!

#### **DANGER**

##### **Serious risk of injury!**

Failure to follow this safety instruction directly endangers the life and health of persons.

#### **WARNING**

##### **Risk of injury!**

Failure to follow this safety instruction endangers the life and health of persons.

#### **CAUTION**

##### **Personal injuries!**

Failure to follow this safety instruction can lead to injuries to persons.

#### **NOTE**

##### **Damage to environment/equipment or data loss**

Failure to follow this instruction can lead to environmental damage, equipment damage or data loss.



#### **Tip or pointer**

This symbol indicates information that contributes to better understanding.

### 1.3 Documentation issue status

Version	Comment
3.2.3	<ul style="list-style-type: none"> <li>• Update Technical data</li> <li>• Update structure</li> </ul>
3.2.2	<ul style="list-style-type: none"> <li>• Update chapter "Update Bus Coupler image"</li> </ul>
3.2.1	<ul style="list-style-type: none"> <li>• Update chapter "Technical data"</li> </ul>
3.2.0	<ul style="list-style-type: none"> <li>• Configuration From firmware Version 8 added</li> <li>• Update chapter "Technical data"</li> </ul>
3.1.0	<ul style="list-style-type: none"> <li>• Update chapter "Notes on the documentation"</li> <li>• Update chapter "EK9300 - PROFINET" -&gt; "EKxxxx - Systemübersicht"</li> <li>• Update chapter "Technical data"</li> <li>• Addenda chapter "Instructions for ESD protection"</li> <li>• Addenda chapter "ATEX - Special conditions (standard temperature range)" and note "ATEX Documentation"</li> <li>• Addenda chapter "UL notice"</li> </ul>
3.0.0	<ul style="list-style-type: none"> <li>• Migration</li> <li>• Update structure</li> </ul>
2.1.0	<ul style="list-style-type: none"> <li>• Chapter <i>CoE data access over PROFINET</i> added</li> <li>• Chapter <i>Multi-configuration mode</i> added</li> <li>• Chapter <i>IO-LINK</i> added</li> </ul>
2.0.0	<ul style="list-style-type: none"> <li>• Addenda and corrections</li> <li>• First published</li> </ul>
1.0.1	<ul style="list-style-type: none"> <li>• Addenda and corrections</li> </ul>
1.0.0	<ul style="list-style-type: none"> <li>• Preliminary version</li> </ul>

#### Image Version EK9300

Firmware	Hardware version	Description
V1.06	3.8	First version

### 1.4 Version identification of EtherCAT devices

#### Designation

A Beckhoff EtherCAT device has a 14-digit designation, made up of

- family key
- type
- version
- revision

Example	Family	Type	Version	Revision
EL3314-0000-0016	EL terminal (12 mm, non-pluggable connection level)	3314 (4-channel thermocouple terminal)	0000 (basic type)	0016
ES3602-0010-0017	ES terminal (12 mm, pluggable connection level)	3602 (2-channel voltage measurement)	0010 (high-precision version)	0017
CU2008-0000-0000	CU device	2008 (8-port fast ethernet switch)	0000 (basic type)	0000

## Notes

- The elements mentioned above result in the **technical designation**. EL3314-0000-0016 is used in the example below.
- EL3314-0000 is the order identifier, in the case of “-0000” usually abbreviated to EL3314. “-0016” is the EtherCAT revision.
- The **order identifier** is made up of
  - family key (EL, EP, CU, ES, KL, CX, etc.)
  - type (3314)
  - version (-0000)
- The **revision** -0016 shows the technical progress, such as the extension of features with regard to the EtherCAT communication, and is managed by Beckhoff.  
In principle, a device with a higher revision can replace a device with a lower revision, unless specified otherwise, e.g. in the documentation.  
Associated and synonymous with each revision there is usually a description (ESI, EtherCAT Slave Information) in the form of an XML file, which is available for download from the Beckhoff web site.  
From 2014/01 the revision is shown on the outside of the IP20 terminals, see Fig. “*EL5021 EL terminal, standard IP20 IO device with batch number and revision ID (since 2014/01)*”.
- The type, version and revision are read as decimal numbers, even if they are technically saved in hexadecimal.

## Identification number

Beckhoff EtherCAT devices from the different lines have different kinds of identification numbers:

### Production lot/batch number/serial number/date code/D number

The serial number for Beckhoff IO devices is usually the 8-digit number printed on the device or on a sticker. The serial number indicates the configuration in delivery state and therefore refers to a whole production batch, without distinguishing the individual modules of a batch.

Structure of the serial number: **KK YY FF HH**

KK - week of production (CW, calendar week)  
YY - year of production  
FF - firmware version  
HH - hardware version

Example with

Ser. no.: 12063A02: 12 - production week 12 06 - production year 2006 3A - firmware version 3A 02 - hardware version 02

Exceptions can occur in the **IP67 area**, where the following syntax can be used (see respective device documentation):

Syntax: D ww yy x y z u

D - prefix designation  
ww - calendar week  
yy - year  
x - firmware version of the bus PCB  
y - hardware version of the bus PCB  
z - firmware version of the I/O PCB  
u - hardware version of the I/O PCB

Example: D.22081501 calendar week 22 of the year 2008 firmware version of bus PCB: 1 hardware version of bus PCB: 5 firmware version of I/O PCB: 0 (no firmware necessary for this PCB) hardware version of I/O PCB: 1

### Unique serial number/ID, ID number

In addition, in some series each individual module has its own unique serial number.

See also the further documentation in the area

- IP67: EtherCAT Box
- Safety: TwinSafe
- Terminals with factory calibration certificate and other measuring terminals

**Examples of markings**



Fig. 1: EL5021 EL terminal, standard IP20 IO device with serial/ batch number and revision ID (since 2014/01)



Fig. 2: EK1100 EtherCAT coupler, standard IP20 IO device with serial/ batch number



Fig. 3: CU2016 switch with serial/ batch number

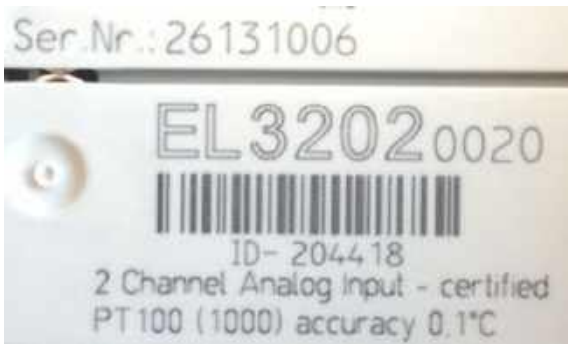

Fig. 4: EL3202-0020 with serial/ batch number 26131006 and unique ID-number 204418



Fig. 5: EP1258-0001 IP67 EtherCAT Box with batch number/ date code 22090101 and unique serial number 158102

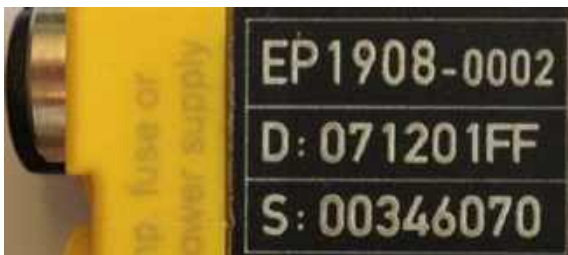

Fig. 6: EP1908-0002 IP67 EtherCAT Safety Box with batch number/ date code 071201FF and unique serial number 00346070



Fig. 7: EL2904 IP20 safety terminal with batch number/ date code 50110302 and unique serial number 00331701



Fig. 8: ELM3604-0002 terminal with unique ID number (QR code) 100001051 and serial/ batch number 44160201

## 2 Product overview

### 2.1 EKxxxx - System overview



Fig. 9: EtherCAT Terminals at an EKxxxx series Bus Coupler

The Bus Couplers from the EKxxxx series allow EtherCAT Terminals to be operated on conventional fieldbus systems. The ultra-fast, high-performance EtherCAT Terminals with their large range of signal types are thus also available for other fieldbus and Industrial Ethernet systems.

The EKxxxx Bus Couplers are fieldbus slaves and contain an EtherCAT master for the EtherCAT terminals. They convert the telegrams from the higher-level fieldbus systems into the E-bus signal representation. A station consists of an EKxxxx and a number of EtherCAT Terminals.

The EKxxxx is integrated in exactly the same way as the Bus Couplers from the BKxxxx series via the corresponding fieldbus system configuration tools and the associated configuration files, such as GSD, ESD or GSDML.

EtherCAT makes a very flexible topology configuration possible. Thanks to the Ethernet physics, long distances can also be bridged without the bus speed being affected. When changing to the field level – without a control cabinet – the EtherCAT Box modules (EPxxxx) in protection class IP65 can also be connected to the EK9xxx.

#### **Bus Couplers for various fieldbus systems**

The variants from the EKxxxx series differ from one another by the interface for the higher-level fieldbus system.

An overview of the various Beckhoff Bus Couplers covering the most important fieldbus systems can be found on the [Beckhoff Website](#).

#### **Embedded PCs with fieldbus interface and decentralized control**

The TwinCAT-programmable variant is the CX80xx Embedded PC series.

The variants from the CX80xx series differ from one another by the interface for the higher-level fieldbus system and the possibility to program it.

An overview of the various Beckhoff Embedded PCs covering the most important fieldbus systems can be found on the [Beckhoff Website](#).

## 2.2 Technical data

Technical data	EK9300
Protocol	PROFINET
Interfaces	2 x Ethernet 100 Mbit/s, 1 x USB device (behind the front flap)
Bus interface	2 x RJ 45 (switched)
I/O connection	E-Bus (EtherCAT terminals)
Web-based Management	from firmware version 8 [ <a href="#">▶ 43</a> ]
I/O terminals	E-bus (EL, ES, EP)
Power supply	24 V <sub>DC</sub> (-15%/+20%)
Input current	120 mA typ. + (total E-bus current)/4
Power contacts	24 V <sub>DC</sub> max./10 A max.
Power supply I/O terminals	2 A
Max. power loss	3 W
Electrical isolation	500 V (power contact/supply voltage/Ethernet)
Max. size of process data	max. 1440 bytes In- and Output data
Dimensions (W x H x L)	64 mm x 100 mm x 73 mm
Operating/storage temperature	0...+55 °C/-25...+85 °C
Relative humidity	95 % no condensation
Vibration/shock resistance	conforms to EN 60068-2-6 / EN 60068-2-27
EMC immunity/emission	conforms to EN 61000-6-2 / EN 61000-6-4
Protect. class / installation pos.	IP20/any
Approvals	CE cULus [ <a href="#">▶ 25</a> ] ATEX [ <a href="#">▶ 24</a> ] IECEX

System data	PROFINET (EK9300)
Number of I/O modules	depending on controller
Number of I/O points	depending on controller
Transmission medium	4 x 2 twisted pair copper cable category 5 (100 Mbaud)
Cable length	100 m
Data transfer rate	100 Mbaud
Topology	Star-form cabling, line topology

## 2.3 Technical data PROFINET

Technical data Ethernet	EK9300
Number of ports	2
integrated switch	2 x Ethernet 100 Mbit/s, 1 x USB device (behind the front flap)
Bus interface	2 x RJ 45 (switched)
100 Mbit/s	Yes, full-duplex PROFINET
Autocrossing	Yes
<b>Protocol</b>	
PROFINET IO DEVICE	Yes
ADS Interface	Yes
<b>Services</b>	
IRT	no
TCP/IP ADS	Yes
Shared Device	Yes
Prioritized startup	no
MRP	Yes
SNMP	Yes
LLDP	Yes
ARP	Yes
LLDP	Yes
DHCP	Yes
<b>Diagnosis/Status/Alarm</b>	
RUN LED	Yes, green/red
PN LED	Yes, green/red
DIAG LED	Yes, green/red
Connection display LINK TX/RX	Yes
Alarms	Yes
Diagnostic messages	Yes

## 3 Mounting and wiring

### 3.1 Mounting

#### 3.1.1 Instructions for ESD protection

##### NOTE

##### **Destruction of the devices by electrostatic discharge possible!**

The devices contain components at risk from electrostatic discharge caused by improper handling.

- ✓ Please ensure you are electrostatically discharged and avoid touching the contacts of the device directly.

a) Avoid contact with highly insulating materials (synthetic fibers, plastic film etc.).

b) Surroundings (working place, packaging and personnel) should be grounded probably, when handling with the devices.

c) Each assembly must be terminated at the right hand end with an [EL9011](#) or [EL9012](#) bus end cap, to ensure the protection class and ESD protection.

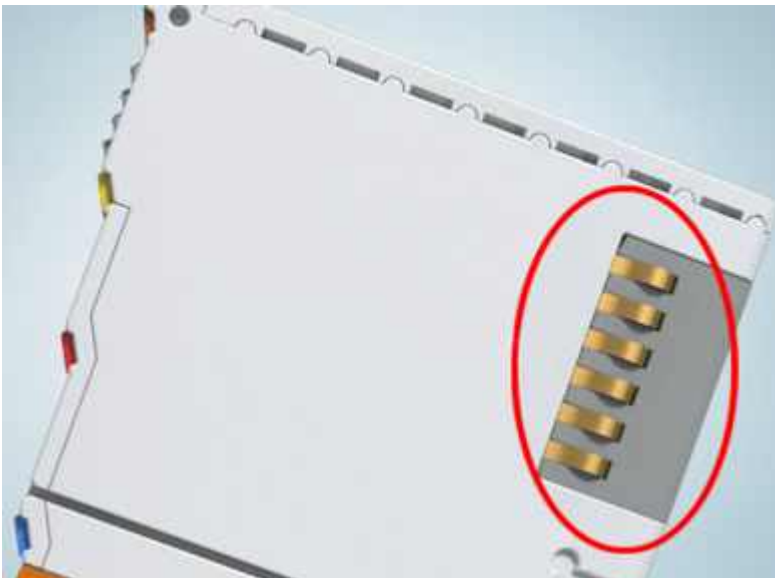

Fig. 10: Spring contacts of the Beckhoff I/O components

### 3.1.2 Dimensions

The following illustrations show the dimensions of the Bus Couplers.

Drawings in DWF and STEP format can be found in the [Download](#) section of the Beckhoff website.



Fig. 11: EK9xxx – dimensions taking the EK9300 as an example

### 3.1.3 Installation on mounting rails – Bus Coupler

#### Snapping onto the mounting rail

The Bus Coupler can simply be snapped onto the mounting rail. To this end position the block on the mounting rail and push it slightly until it engages on the right-hand side. This is indicated by a distinct click. Use a screwdriver to push up the lock on the left-hand side, thereby turning it and causing it to engage audibly.

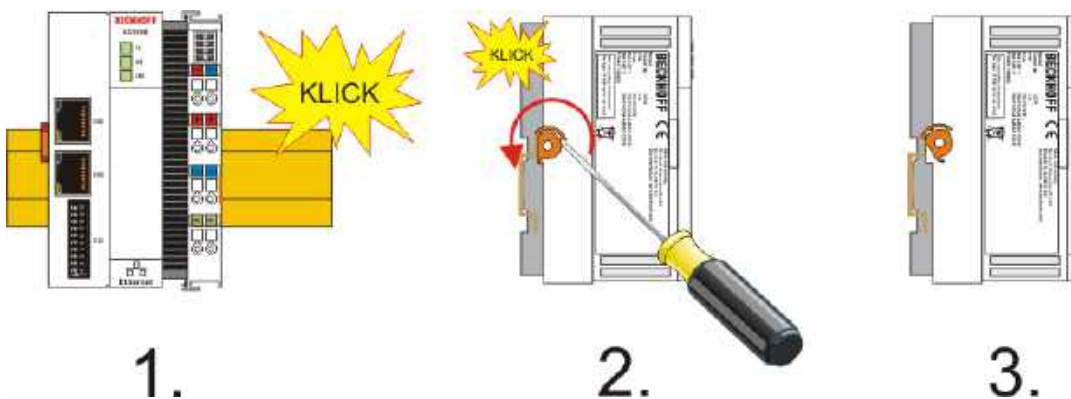

Fig. 12: EK9300 - Snapping onto the mounting rail

#### NOTE

##### Avoid damage!

Do not force the module or apply excessive pressure!

#### Installation positions

The installation position of the Bus Coupler is arbitrary.

**NOTE**

**Installation position of EtherCAT terminals**

Observe the installation position of the EtherCAT terminals used – not all of them have an arbitrary installation position. Pay attention to the respective EtherCAT infrastructure components and installation instructions.

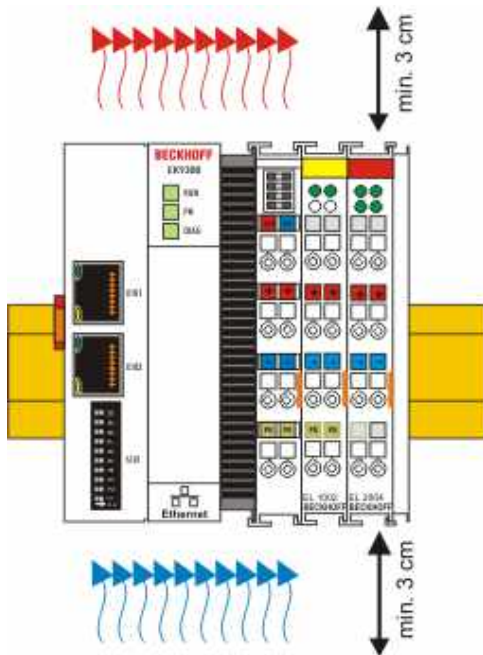

Fig. 13: Recommended distances for standard installation position

**NOTE**

**Comply with the permitted installation position and minimum distances!**

We recommend the installation in the horizontal position for optimum ventilation. Furthermore, it is not necessary with this installation position to check whether there are terminals present that may only be installed horizontally.

Other installation positions are allowed, but not recommended.

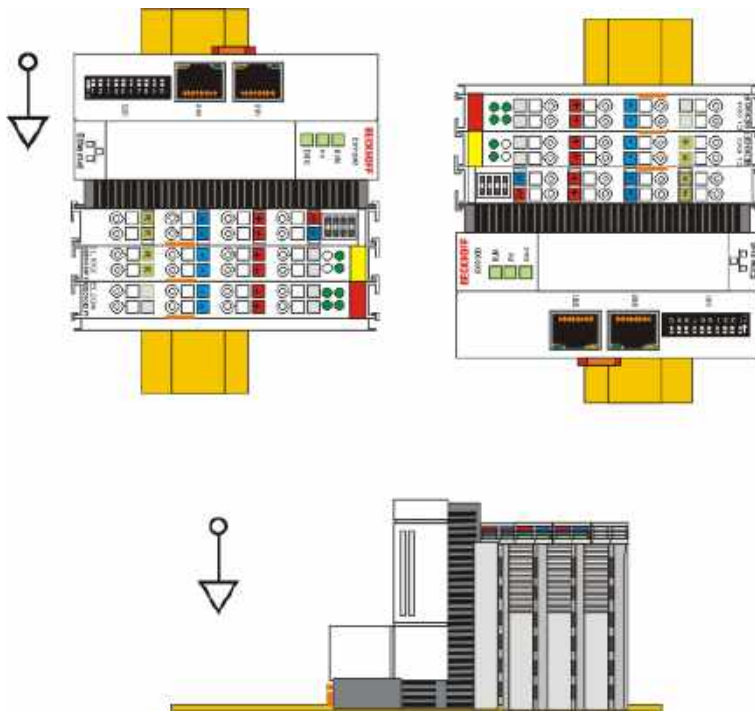

Fig. 14: Other installation positions

## 3.2 Wiring

### 3.2.1 Power supply

The power supply unit is equipped with an I/O interface, which permits connection of the Beckhoff Bus Terminals. The power is supplied via the upper spring-loaded terminals with the designations "24 V and "0 V".

The supply voltage supplies the EK system and, via the terminal bus, the Bus Terminals with a voltage of 24 V<sub>DC</sub> (-15%/+20 %). The dielectric strength of the power supply is 500 V. Since the terminal bus (E-bus) only transfers data, a separate power supply is required for the Bus Terminals. This is provided by means of the power contacts, which are not connected to the power supply.

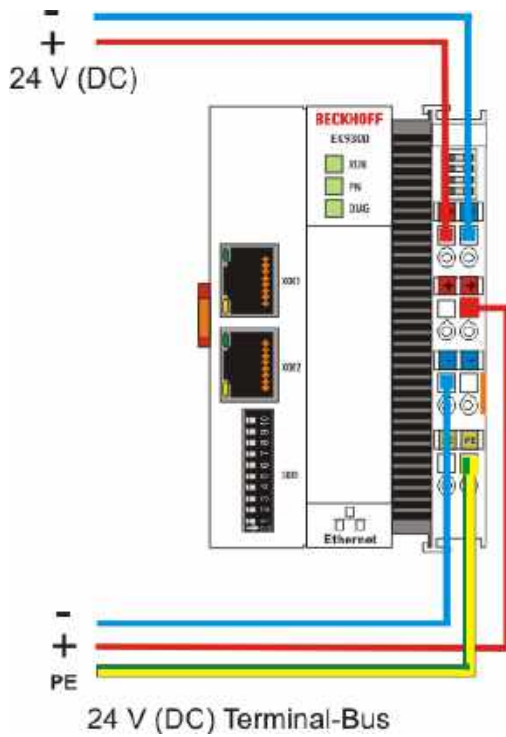

Fig. 15: Bus Coupler EK9300 power supply

**Requirements for the 24 V power supply**

In order to guarantee the operation of the Bus Coupler and the terminal segment in all cases, the power supply unit must supply 2.0 A at 24 V.

**LED**

If the power supply unit is connected correctly and the power supply is switched on, the two upper LEDs in the terminal prism are green. The left LED (Us) indicates the CPU supply. The right LED (Up) indicates the terminal supply. The other LEDs indicate the Terminal Bus status. A detailed description of the LEDs can be found in section "LED troubleshooting".

**PE power contacts**

<b>NOTE</b>	
<b>Power contact "PE"</b>	The "PE" power contact must not be used for other potentials.

## 3.2.2 Ethernet

### 3.2.2.1 Ethernet connections



Fig. 16: RJ45 interface

#### Assignment of the RJ45 interface, port 1

X001

PIN	Signal	Description
1	TD +	Transmit +
2	TD -	Transmit -
3	RD +	Receive +
4	connected	reserved
5		
6	RD -	Receive -
7	connected	reserved
8		

#### Assignment of the RJ45 interface, port 2 (switched)

CX8010, CX809x: X101/102

EK9xxx: X001 / X002

PIN	Signal	Description
1	TD +	Transmit +
2	TD -	Transmit -
3	RD +	Receive +
4	connected	reserved
5		
6	RD -	Receive -
7	connected	reserved
8		

### 3.2.2.2 Ethernet cable

#### Transmission standards

##### 10Base5

The transmission medium for 10Base5 consists of a thick coaxial cable ("yellow cable") with a max. transmission speed of 10 Mbaud arranged in a line topology with branches (drops) each of which is connected to one network device. Because all the devices are in this case connected to a common transmission medium, it is inevitable that collisions occur often in 10Base5.

##### 10Base2

10Base2 (Cheaper net) is a further development of 10Base5, and has the advantage that the coaxial cable is cheaper and, being more flexible, is easier to lay. It is possible for several devices to be connected to one 10Base2 cable. It is frequent for branches from a 10Base5 backbone to be implemented in 10Base2.

##### 10BaseT

Describes a twisted pair cable for 10 Mbaud. The network here is constructed as a star. It is no longer the case that every device is attached to the same medium. This means that a broken cable no longer results in failure of the entire network. The use of switches as star couplers enables collisions to be reduced. Using full-duplex connections they can even be entirely avoided.

##### 100BaseT

Twisted pair cable for 100 Mbaud. It is necessary to use a higher cable quality and to employ appropriate hubs or switches in order to achieve the higher data rate.

##### 10BaseF

The 10BaseF standard describes several optical fiber versions.

#### Short description of the 10BaseT and 100BaseT cable types

Twisted-pair copper cable for star topologies, where the distance between two devices may not exceed 100 meters.

##### UTP

Unshielded twisted pair

This type of cable belongs to category 3, and is not recommended for use in an industrial environment.

##### S/UTP

Screened/unshielded twisted pair (screened with copper braid)

Has an overall shield of copper braid to reduce influence of external interference. This cable is recommended for use with Bus Couplers.

##### FTP

Foiled shielded twisted pair (screened with aluminum foil)

This cable has an overall shield of laminated aluminum and plastic foil.

##### S/FTP

Screened/foiled-shielded twisted pair (screened with copper braid and aluminum foil)

Has a laminated aluminum screen with a copper braid on top. Such cables can provide up to 70 dB reduction in interference power.

**STP**

Shielded twisted pair

Describes a cable with an outer screen, without defining the nature of the screen any more closely.

**S/STP**

Screened/shielded twisted pair (wires are individually screened)

This identification refers to a cable with a shield for each of the two wires as well as an overall shield.

**ITP**

Industrial Twisted-Pair

The structure is similar to that of S/STP, but, in contrast to S/STP, it has only one pair of conductors.

### 3.2.2.3 EK9300 PROFINET topology sample

#### EK9300

The construction of the EK9300 can take place in a line, with adherence to the following points:

- Maximum 20 couplers one behind the other
- No switches should be used in the line

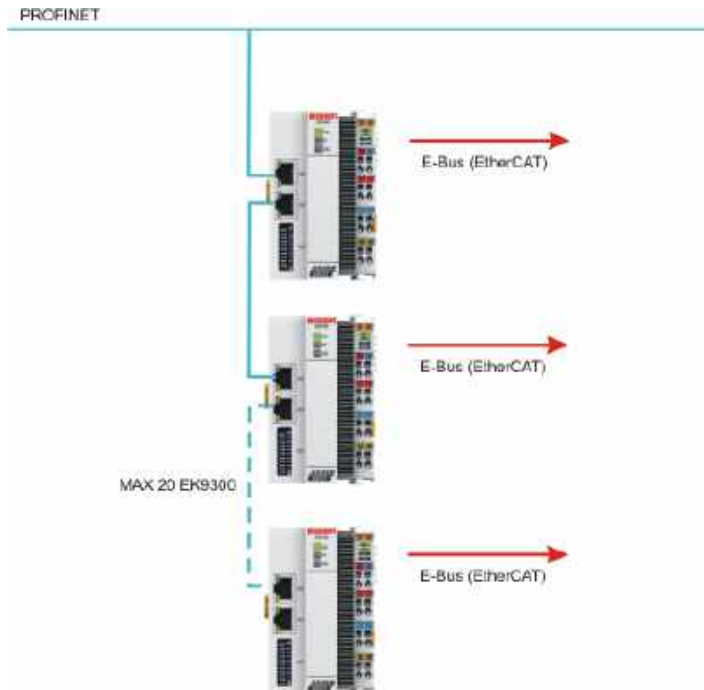

Fig. 17: EK9300 - Topology sample

#### **i** Use of switches without LLDP

PROFINET uses the LLDP protocol for the topology recognition. The topology recognition and the associated PROFINET services will not work properly if the switch that you use does not support this. In addition, this results in increased network traffic, which is multiplied further with each switch port and connected PROFINET device. The effects of this can be communication errors extending up to the aborting of communication with individual PROFINET devices.

### 3.2.3 ATEX - Special conditions (standard temperature range)

#### ⚠ WARNING

**Observe the special conditions for the intended use of Beckhoff fieldbus components with standard temperature range in potentially explosive areas (directive 94/9/EU)!**

- The certified components are to be installed in a suitable housing that guarantees a protection class of at least IP54 in accordance with EN 60529! The environmental conditions during use are thereby to be taken into account!
- If the temperatures during rated operation are higher than 70°C at the feed-in points of cables, lines or pipes, or higher than 80°C at the wire branching points, then cables must be selected whose temperature data correspond to the actual measured temperature values!
- Observe the permissible ambient temperature range of 0 to 55°C for the use of Beckhoff fieldbus components standard temperature range in potentially explosive areas!
- Measures must be taken to protect against the rated operating voltage being exceeded by more than 40% due to short-term interference voltages!
- The individual terminals may only be unplugged or removed from the Bus Terminal system if the supply voltage has been switched off or if a non-explosive atmosphere is ensured!
- The connections of the certified components may only be connected or disconnected if the supply voltage has been switched off or if a non-explosive atmosphere is ensured!
- The fuses of the KL92xx/EL92xx power feed terminals may only be exchanged if the supply voltage has been switched off or if a non-explosive atmosphere is ensured!
- Address selectors and ID switches may only be adjusted if the supply voltage has been switched off or if a non-explosive atmosphere is ensured!

#### Standards

The fundamental health and safety requirements are fulfilled by compliance with the following standards:

- EN 60079-0:2012+A11:2013
- EN 60079-15:2010

#### Marking

The Beckhoff fieldbus components with standard temperature range certified for potentially explosive areas bear one of the following markings:



II 3G KEMA 10ATEX0075 X Ex nA IIC T4 Gc Ta: 0 ... 55°C

or



II 3G KEMA 10ATEX0075 X Ex nC IIC T4 Gc Ta: 0 ... 55°C

### 3.2.4 ATEX Documentation



**Notes about operation of the Beckhoff terminal systems in potentially explosive areas (ATEX)**

Pay also attention to the continuative documentation

Notes about operation of the Beckhoff terminal systems in potentially explosive areas (ATEX)

that is available in the download area of the Beckhoff homepage <http://www.beckhoff.com/>

### 3.2.5 UL notice

	<p><b>Application</b> Beckhoff EtherCAT modules are intended for use with Beckhoff's UL Listed EtherCAT System only.</p>
	<p><b>Examination</b> For cULus examination, the Beckhoff I/O System has only been investigated for risk of fire and electrical shock (in accordance with UL508 and CSA C22.2 No. 142).</p>
	<p><b>For devices with Ethernet connectors</b> Not for connection to telecommunication circuits.</p>

#### Basic principles

Two UL certificates are met in the Beckhoff EtherCAT product range, depending upon the components:

1. UL certification according to UL508. Devices with this kind of certification are marked by this sign:



2. UL certification according to UL508 with limited power consumption. The current consumed by the device is limited to a max. possible current consumption of 4 A. Devices with this kind of certification are marked by this sign:

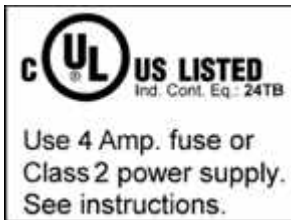

Almost all current EtherCAT products (as at 2010/05) are UL certified without restrictions.

#### Application

If terminals certified *with restrictions* are used, then the current consumption at 24 V<sub>DC</sub> must be limited accordingly by means of supply

- from an isolated source protected by a fuse of max. 4 A (according to UL248) or
- from a voltage supply complying with *NEC class 2*.  
A voltage source complying with *NEC class 2* may not be connected in series or parallel with another *NEC class 2* compliant voltage supply!

These requirements apply to the supply of all EtherCAT bus couplers, power adaptor terminals, Bus Terminals and their power contacts.

## 4 Parameterization and commissioning

### 4.1 Meaning of the DIP switch

#### 10-pole DIP switch S001

The DIP switch has the following meaning for the Ethernet interfaces X001 and X002, which are switched:



Fig. 18: DIP switch S001: Left off "0", right on "1"

DIP 9	DIP 10	Description DIP 1..8	Restart behavior	Behavior with factory settings
0	0	Last byte of the IP address via DIP switches 1 to 8	<ul style="list-style-type: none"> <li>PN name from memory</li> <li>IP address via DIP switches 172.16.17.xxx (xxx DIP switch)</li> <li>SNM 255.255.0.0</li> </ul>	<ul style="list-style-type: none"> <li>PN name becomes empty string</li> <li>IP address via DIP switches 172.16.17.xxx (xxx DIP switch)</li> <li>SNM 255.255.0.0</li> </ul>
0	1	DHCP DIP switch 1 to 8 set to OFF	<ul style="list-style-type: none"> <li>PN name from memory</li> <li>IP address and SNM via DHCP</li> </ul>	<ul style="list-style-type: none"> <li>PN name becomes empty string</li> <li>IP address and SNM via DHCP</li> </ul>
		DHCP DIP switch 1 to 8 set to ON	<ul style="list-style-type: none"> <li>PN name from memory</li> <li>IP address from memory</li> </ul>	<ul style="list-style-type: none"> <li>PN name becomes empty string</li> <li>IP address 0.0.0.0</li> </ul>
1	0	Reserved		
1	1	PROFINET-compliant DIP switch 1 to 8 set to OFF	<ul style="list-style-type: none"> <li>PN name from memory</li> <li>IP address from memory</li> </ul>	<ul style="list-style-type: none"> <li>PN name becomes empty string</li> <li>IP address 0.0.0.0</li> </ul>
		PROFINET with fixed name DIP switch 1 to 8 set to ON	<ul style="list-style-type: none"> <li>PN name via DIP switch 1 to 8</li> <li>IP address from memory</li> </ul>	<ul style="list-style-type: none"> <li>PN name via DIP switch 1 to 8</li> <li>IP address 0.0.0.0</li> </ul>

#### 2-pole DIP switch (under the flap between the battery and the SD card slot)

DIP switch (red)	Meaning
1 off and 2 off	normal mode, coupler is started
1 on and 2 off	The EK starts in Config Mode; the internal Flash memory can be accessed via the USB interface (for example for an image update).
1 off and 2 on	Manufacturer's setting
1 on and 2 on	No function so far

### 4.2 Further interfaces

Additional interfaces are located under the flap of the EK9xx0.

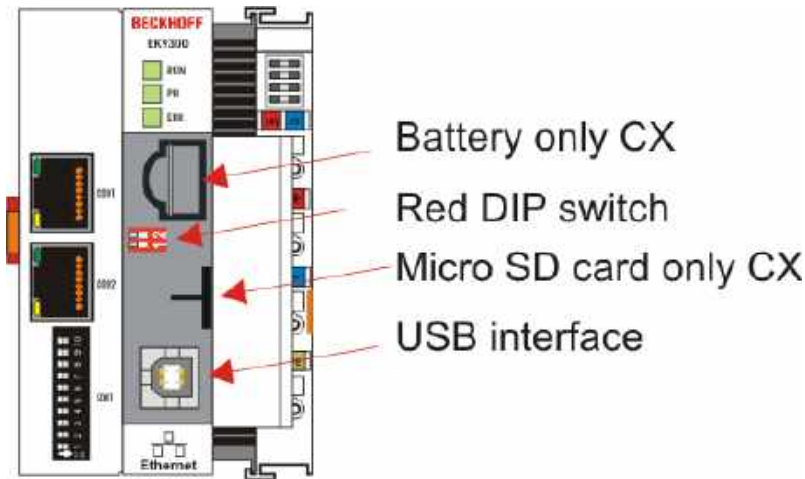

Fig. 19: Additional interfaces of the EK9xx0

**Battery**

No battery is required for the EK9xx0, therefore this option is not included.

**Red DIP switch**

Default setting is OFF/OFF.

In order, for example, to load new firmware to the EK via USB, the first DIP switch must be set to “1” before switching on. If the RUN LED lights up blue, the EK can be connected to the PC by a USB cable. The PC then finds the internal Flash as the storage medium. The storage medium may not be formatted!

**Micro SD card**

Alternatively the firmware can also be loaded to an SD card. Booting always takes place from the SD card if there is one in the slot. This can be used, for example, to test a firmware before copying it to the EK’s internal Flash.

**USB interface**

The USB interface can only be used if the “red” DIP switch has been set accordingly. See “Red DIP switch”.

**4.3 Setting the IP address**

Usually the IP address is assigned by the PROFINET controller. By default the EK9300 has no IP address. An IP address is necessary, however, in order to reach the device by ADS. This can be assigned by DHCP (a DHCP server must be present) or a fixed IP address can be used. See chapter [DIP switch \[▶ 26\]](#).

If the PROFINET controller is connected, the IP address assigned by the controller is used for PROFINET communication. The fixed IP address or the one assigned by the DHCP is overwritten.

A further possibility is to communicate with the EK9300 via the IP address assigned by the controller; to do this, however, the device must have been initialized at least once by the PROFINET controller/engineering.

## 5 Configuration

### 5.1 EK9300 configuration



#### GSDML file

Only terminals existing in the GSDML file are supported; extensions are possible however. The GSDML supports submodules; ascertain whether your PROFINET master/controller supports these submodules. If this is not the case, some terminals cannot be used!

Alternatively the CX8093 can be used; this generally supports all EtherCAT slaves.

#### General

The EK9300 PROFINET coupler is always integrated with the help of a GSDML file in the controller (master). The GSDML file contains all parameterization data necessary for the operation of the coupler on the controller. The configuration tool reads this file and then provides the data to the user.

The respective terminals that are usable on the EK9300 are also specified in the GSDML file. Not all EtherCAT terminals are supported. Therefore, ascertain beforehand whether the terminals that you wish to use are also supported by the coupler.

#### Data in the DAP (Device Access Point)

2 x 2 bytes of data are located in the DAP of the GSDML file.

This is once the ECCycleCounter (2 bytes). This is incremented on each EtherCAT cycle (1 ms), provided that the EC master is in the "OP" state.

The status (2 BYTE) is located at the DAP. This indicates individual status information bit by bit. These are currently occupied as follows:

- Bit 0 – IsSynchron – this is set if it is used as a PTP slave or IRT device and is synchronous.
- Bit 1 – IsPTPMaster – this is set if the EK9300 is operated as the PTP master.
- Bit 2 – ECFrameError – this is set if an EtherCAT problem is determined. In order to obtain further information about this, the PROFINET diagnosis or the alarms must be read out.

#### Parameters in the DAP

**Activate PN reset value** – *Off* -> EtherCAT data are written to zero. *On* -> there is a possibility to use another default value with outputs. With digital outputs, for example, the current output process value can be frozen or set to 0 or 1 in case of a PROFINET communication error.

**Data presentation** – *Intel Format* data are represented in Intel format, *Motorola Format* data are represented in Motorola format. In Word variables, for example, the high and low bytes are exchanged.

**EBus error behavior** – *Set IOs to 0* -> input and output data are set to zero in case of an EC error. *Legacy* -> input data retain their last state, but are no longer updated; output data can still be set (depending on the position of the terminal).

#### Mapping

Typically the coupler is used in a group with terminals that are connected to the coupler. The terminals are part of the GSDML; the terminals are parameterized from the PROFINET controller.

The mapping is card-slot-oriented, i.e. you must enter the terminals in the hardware configurator in exactly the same way as they are physically connected. It becomes a little more complicated if EtherCAT distributor boxes are used. In this case it is important to know the order in which the other EtherCAT terminals were entered into the process image (see [EtherCAT Mapping \[▶ 30\]](#)).

## **i** Behavior when starting the Bus Coupler

All EtherCAT devices must always be present when starting the Bus Coupler (or resetting), i.e. all EtherCAT slaves must be supplied with power before or at the same time so that the coupler on the PROFINET also starts up properly.

A solution can be constructed more flexibly with the CX8093.

## Configuration of the EtherCAT devices

There are 4 types of EtherCAT devices:

- EtherCAT devices without process data
- EtherCAT devices with “simple” process data but without parameterization (usually simple digital terminals)
- EtherCAT devices with “simple” process data and with parameters (usually analog signals)
- EtherCAT devices with different process data and parameters (for example incremental encoders)

All of these must be entered in the configuration.

## Grouping digital inputs and outputs (pack terminals)

The digital input and output terminals can also be grouped according to their process data. This option can be used with 2 or 4-channel terminals. To do this a 2 or 4-channel pack terminal (without asterisk) must be appended to the GSDML file. In order to fill the byte, a 2 or 4-channel pack terminal (with asterisk) must be appended next. The terminals must be physically and systematically plugged in one behind the other or logically. The byte limit must not be exceeded.

Sample:

2-channel pack (without asterisk), after that 3 modules from 2-channel pack terminals (with asterisk) may be appended.

Not permitted:

2-channel pack (without asterisk), then 2 modules from 4-channel pack terminals (with asterisk). This exceeds the byte limit.

## EtherCAT terminals with different mapping options

Some EtherCAT terminals offer the option to represent different process data. These are represented differently on the basis of the parameters. In the PROFINET controller such a terminal is represented by submodules. The standard mapping is always integrated. If you want to use a different mapping that deviates from the standard, then delete the standard submodule and insert the one that you wish to use. It may be the case that, contradictory to the documentation for the EtherCAT terminal or EtherCAT box, not all mappings can be used under the PROFINET coupler.

Example of an EL5101:

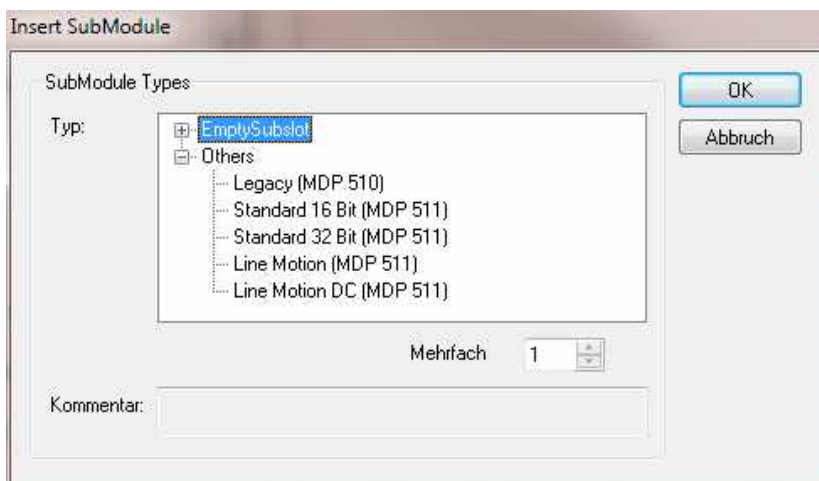

Fig. 20: Inserting a sub-module

## **EtherCAT gateway terminals**

The gateway terminals support several submodules; the first or basic module is loaded immediately, the modules for the process data must be created. These must then also be parameterized on the master side of the corresponding gateway. Not all features of a gateway terminal can be used on the EK9300.

### **EL6631-0010**

The PROFINET device terminal enables two different PROFINET networks to be connected; only one device interface is supported on the EK. A default station name can be assigned and IP settings made via parameterization data (GSDML). Note that the complete maximum data length of the EL6631-0010 cannot be used. The length is dependent on the other EtherCAT devices attached to the EK9300.

### **EL6731-0010**

The PROFIBUS slave terminal enables communication with a PROFIBUS master. The PROFIBUS address is specified via the parameter settings (in the GSDML) in the terminal. Only pure process data can be exchanged.

### **EL6692**

The EtherCAT slave terminal enables communication with a EtherCAT master. Only pure process data can be exchanged.

### **EL6652-0010**

The EtherNet/IP slave terminal enables communication with an EtherNet/IP master; only one slave interface is supported on the EK. The IP address and subnet mask are specified via the parameter settings (in the GSDML) of the terminal. Only pure process data can be exchanged. The terminal on the EK supports only one slave interface.

## **5.2 EK9300 EtherCAT configuration**

The EK9300 is an EtherCAT master with automatic configuration, i.e. all EtherCAT terminals must always be present when switching on the system. Since the boot-up of the EK9300 generally takes considerably longer than the start-up of the EtherCAT slave devices, the latter can be operated on the same power supply. With decentralized EtherCAT slaves, care must be taken that they are switched on earlier or at the same time as the supply voltage.

### **Switching EtherCAT devices on or off during the runtime**

If one or more EtherCAT devices should fail during the operating phase, a plug alarm is sent; the EK9300 remains in data exchange. The input data of all EtherCAT devices are invalid and are set to FALSE or ZERO; the output data are no longer accepted. This also applies to the devices that are still in operation on the EK9300. If you wish to use the option to plug in or unplug devices during the runtime, a further "Sync Unit" must be configured. This is not possible with an EK9300. In this case use a CX8093.

### **EtherCAT devices that don't exist in the GSDML**

Some EtherCAT Slaves are not included in the GSDML and thus cannot be used (yet). The CX8093 can be used here, since it supports all EtherCAT devices in principle.

### **EtherCAT topology**

All EtherCAT devices must be entered in the order in which they map themselves on the EK9300 and thus on the EtherCAT master. EtherCAT devices are addressed automatically; with a few exceptions all EtherCAT Bus Terminals are equipped with an EtherCAT ASIC, which has to be entered in the system, i.e. the PROFINET controller. EtherCAT Terminals without an ASIC are, for example, EL9400, EL9070 and other EL9xxx. You can identify these EtherCAT Terminals using the technical data "Message to E-bus". If there is a "-" here, this terminal does not have to be entered in the PROFINET controller.

EtherCAT devices are registered in the direction of the EtherCAT telegram.

**Sample configuration with EK1100 EtherCAT coupler**

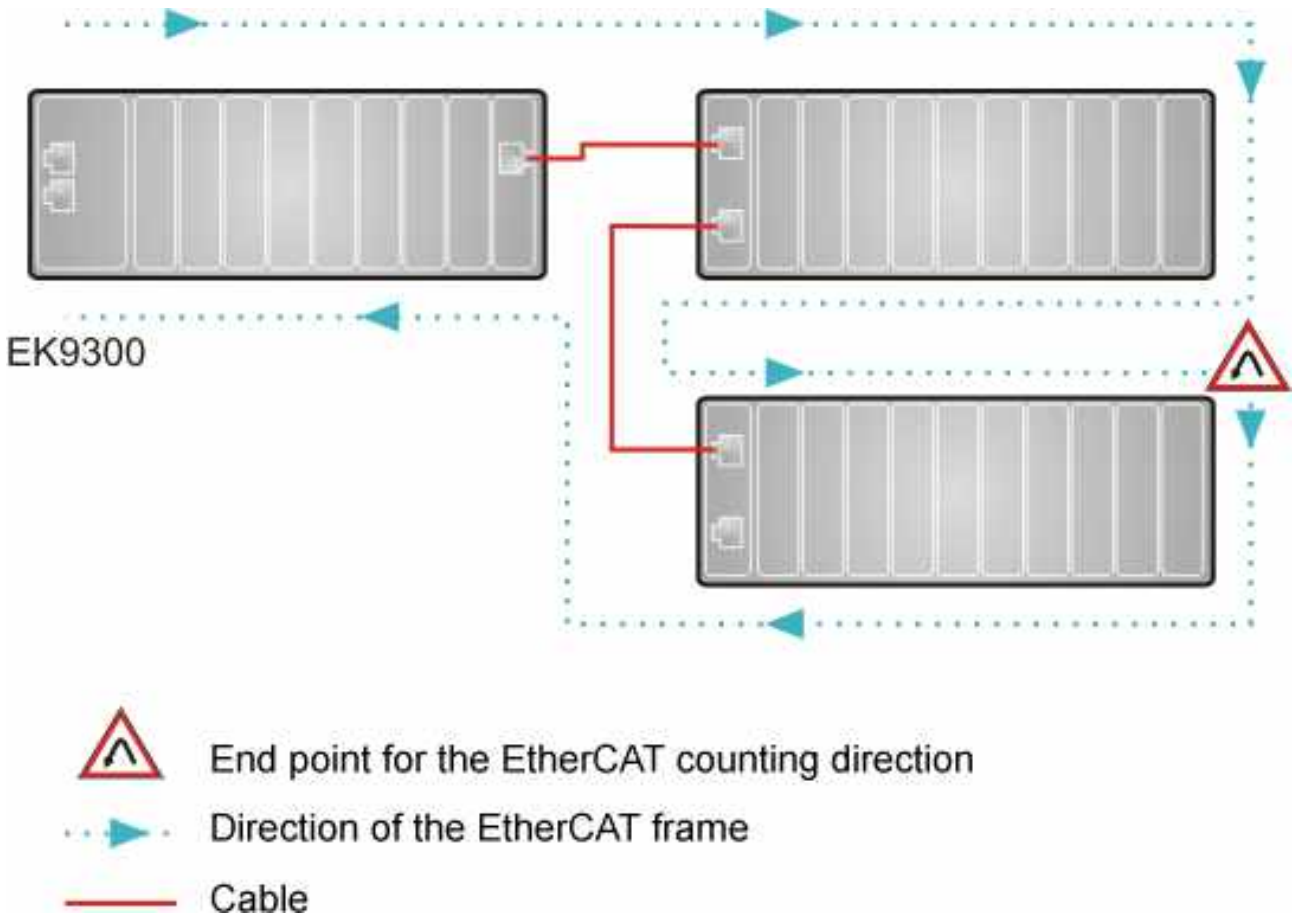

Fig. 21: Sample configuration with EK1100 EtherCAT coupler

**Sample configuration with EPxxxx EtherCAT Box**

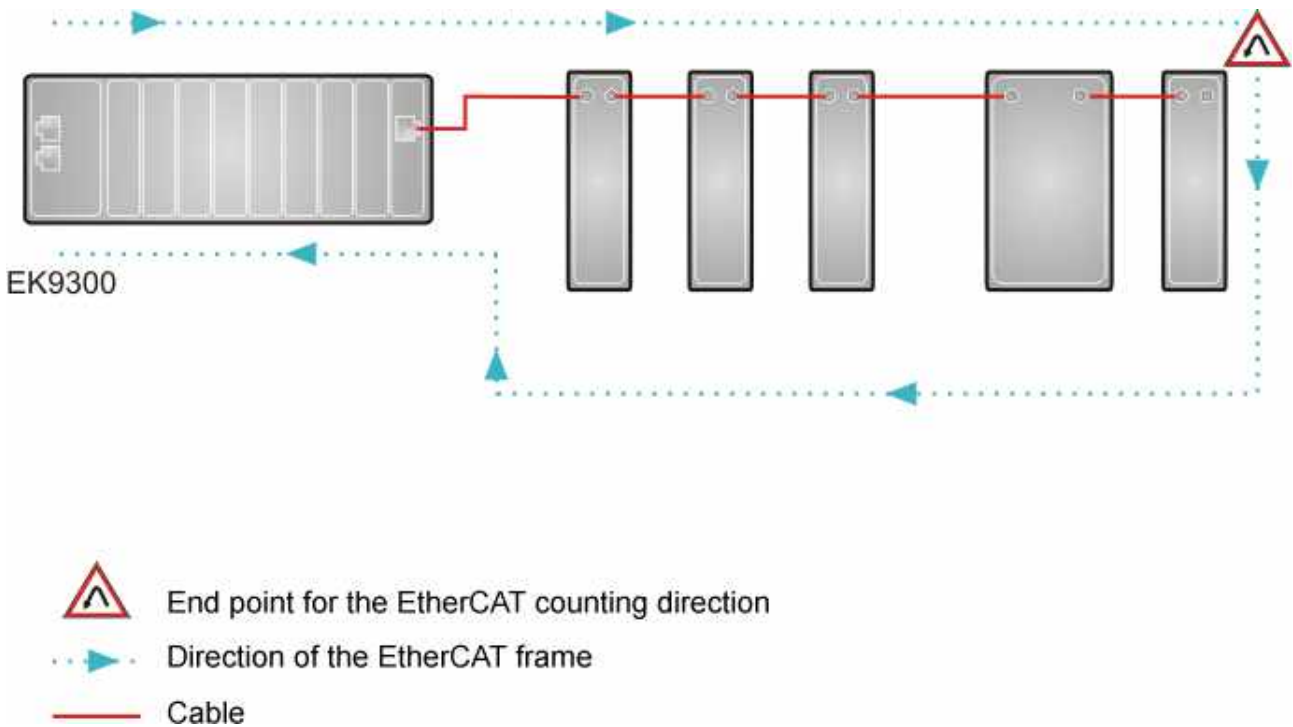

Fig. 22: Sample configuration with EPxxxx EtherCAT Box

**Sample configuration with EK1122 2-port EtherCAT junction**

The counting direction is to be observed when using an EK1122. If EtherCAT junction 1 on the EK1122 is connected, then the EtherCAT frame is forwarded here first (1); if junction 1 is not connected the frame on junction 2 is sent (2), only after that does the sequence continue with the E-bus on the right-hand side (3).

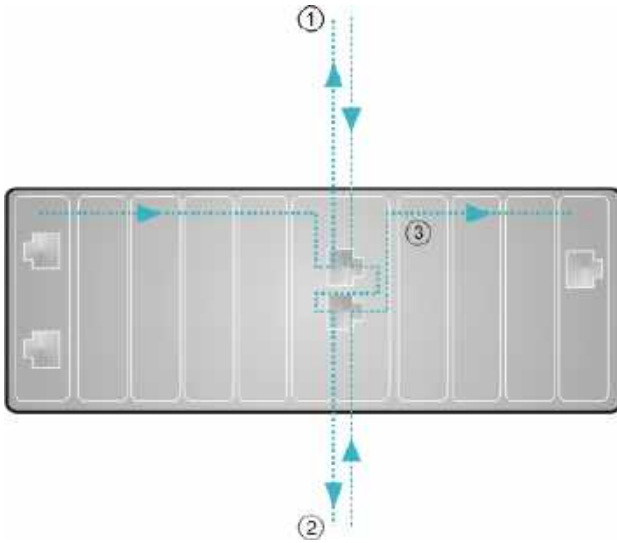

Fig. 23: Sample configuration with EK1122 2-port EtherCAT junction

If both junctions are not used, then junction 1 and 2 are short-circuited as it were and the EC frame continues directly from the terminal to the right. Note that in the PROFINET controller the modules are entered in the direction of the EtherCAT frame.

**Sample configuration with EP1122 2-port EtherCAT junction**

The counting direction is to be observed when using an EP1122; it is comparable with the EK1122. If EtherCAT junction 1 on the EP1122 is connected, then the EtherCAT frame is forwarded here first (1); if junction 1 is not connected the frame on junction 2 is sent (2), only after that does the sequence continue with the EC-bus on the right-hand side (3).

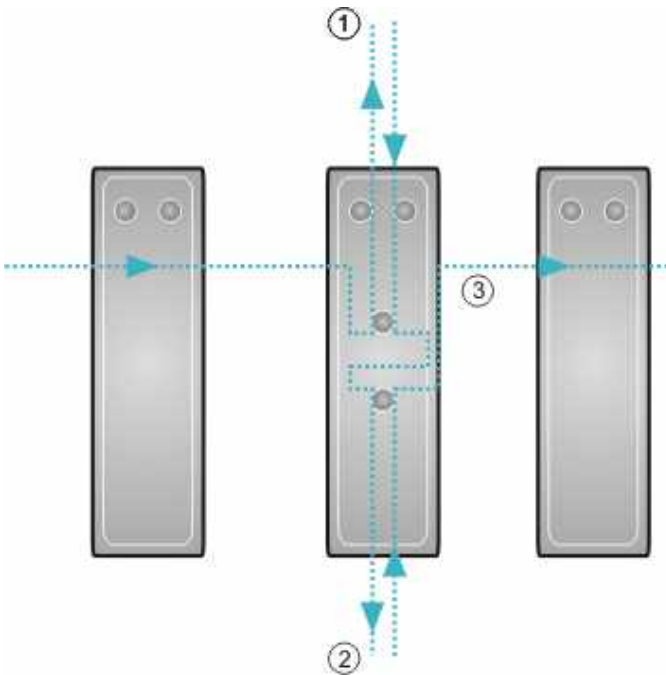

Fig. 24: Sample configuration with EP1122 2-port EtherCAT junction

If both junctions are not used, then junction 1 and 2 are short-circuited as it were and the EC frame continues directly from the terminal to the right. Note that in the Profinet controller the modules are entered in the direction of the EtherCAT frame.

**Connection during operation**

You cannot use the EP1122 and EK1122 for Hot Swap or connect or disconnect them during operation. The EP1122 and EK1122 are suitable in conjunction with the EK coupler only as topology extensions (star).

---

## 5.3 EK9300 – Configuration example

### PDO Mapping

The process data on the EtherCAT side are described via the PDO Mapping. The individual terminals bring along a pre-defined PDO mapping, i.e. a practical combination of individual PDOs, via the ESI file (EtherCAT description file).

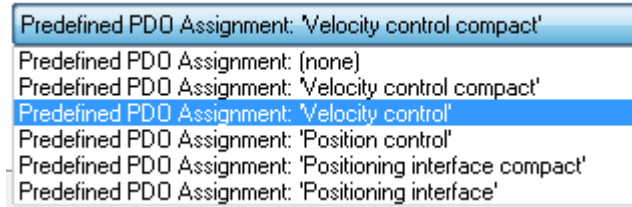

Fig. 25: EK9300 - Predefined PDO selection dialog

These combinations are described in turn on the Profinet side using different submodules and thus process data; i.e. each pre-defined PDO mapping has an associated submodule.

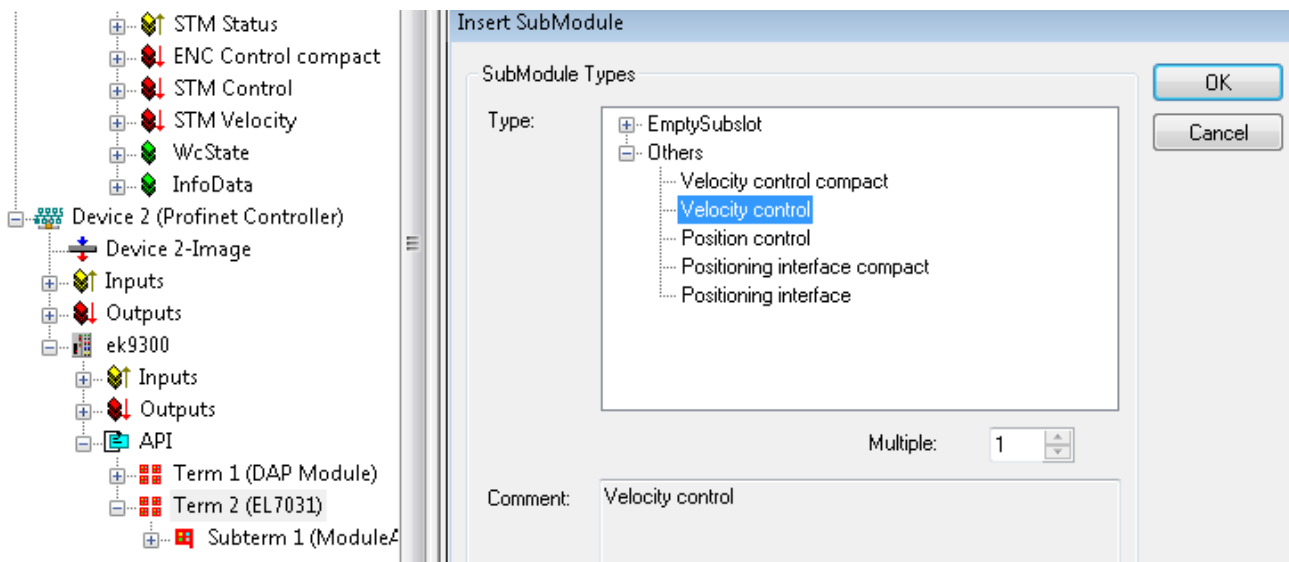

Fig. 26: EK9300 Sub-modules

Such modular terminals always have a fixed submodule plugged into subslot 1 on the EK9300. This is the placeholder for the terminal itself; i.e. the generally valid diagnosis for the terminal is operated via this. The actual process data are plugged into subslot 2 and the PDO mapping on the EC-master is generated on their basis.

### SDO Mapping

Each of the plugged-in subslots can bring along parameterization data. The Service Data Objects (SDOs) are transmitted via these data, i.e. the SDOs are mapped to record data sets. The objects 0x8xxx and 0xF8xx are always mapped. Since the indices on the PROFINET side are only vendor-specific from 0 - 0x7FFF, the EtherCAT objects 0x8xxx correspond to the PROFINET record indices 0x3xxx and the EC objects 0xF8xx to the PROFINET index range 0x48xx. In PROFINET the records are always written during the controller start-up phase; they are transferred internally to the EtherCAT master as start-up SDOs. This means that the internal EC master is also restarted during a PROFINET restart.

General		Parameterize Module			
[-] EC Slave Init Values		Name	R/W	Offline Value	Or
[-] Index 0x2009		Operation mode	R/W	Automatic	
[-] ENC Settings Ch.1		Speed range	R/W	2000 Fullsteps/sec	
[-] Index 0x3000		Invert motor polarity	R/W	False	
[-] STM Motor Settings Ch.1		Select info data 1	R/W	Motor coil current A	
[-] Index 0x3010		Select info data 2	R/W	Motor coil current B	
[-] STM Controller Settings Ch.1		Invert digital input 1	R/W	False	
[-] Index 0x3011		Invert digital input 2	R/W	False	
[-] STM Features Ch.1		Function for input 1	R/W	Normal input	
[-] Index 0x3012		Function for input 2	R/W	Normal input	
[-] STM Controller Settings 2 Ch.					
[-] Index 0x3013					
[-] PDS Settings Ch.1					
[-] Index 0x3020					
[-] PDS Features Ch.1					
[-] Index 0x3021					

Fig. 27: PROFINET record indices 0x3xxx (corresponds to EtherCAT objects 0x8xxx)

These data records can also be read and written during operation.

### Commissioning EL7031

The default settings are adequate for initial commissioning, i.e. only the corresponding submodule needs to be selected. The PDOs and SDOs of the terminal are parameterized on that basis. For example, if the "Velocity Control" submodule is selected, only the *Control\_Enable* bit needs to be set; subsequently turn the motor by specifying a setpoint speed.

## 5.4 From firmware Version 6

### 5.4.1 EK9300 - CoE data access over PROFINET

#### Description

CoE means **Can over EtherCAT**. It enables access to all parameters of an EtherCAT device. The CoE data model is based on the principles of CANopen and uses index and subindex for reading from and writing to parameters, if the corresponding access is enabled.

Further information can be found here: [System Documentation](#)

#### Task

Parameters of an EtherCAT device can generally be set and parameterized via the parameters of the GSDML file. However, in some applications it is necessary to change certain parameters at runtime or to carry out optimizations during operation.

#### Solution

The CoE data are sent via acyclic PROFINET services (PROFINET index 0x200F). The position of the EtherCAT device is specified via the slot number. The CoE data are then entered in the record data. During reading they consist of CoE index and CoE subindex, during writing they consist of CoE index, CoE subindex and the data to be sent.

#### Reading/writing sample

For reading, a WriteReq record must be sent first. This includes the CoE index and CoE subindex. After the WriteRsp a ReadReq has to be sent in order to retrieve the data, which are then contained in the ReadRsp.

Writing takes place in the same way, except that WriteReq includes the data, and ReadRsp serves as acknowledgement to indicate whether writing was successful.

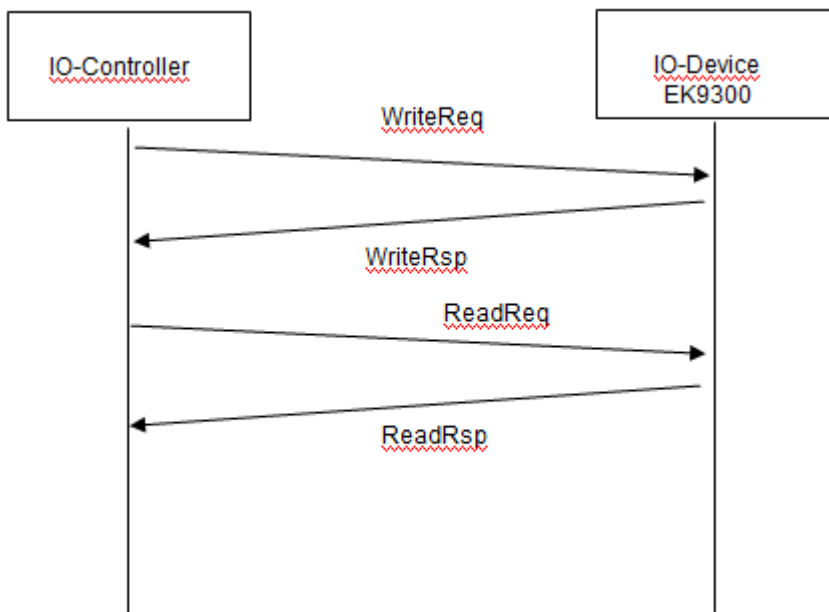

Fig. 28: CoE data access over PROFINET, read/write sample

**Getting Started - Reading**

PROFINET record data (write request)	Value	Meaning
Slot	Position of the EtherCAT device (1...255)	Slot number, position of the EtherCAT device
SubSlot	1	Sub-slot number, always "1"
Index	0x200F	PROFINET index number
Length	4	Length of the following data
Data	Bytes 1 and 2 SDO index Byte 3 CoE subindex Byte 4 "0" reserve	CoE data

Delay time, we recommend 100..250 ms until the read request is sent, which includes an acknowledgment of error-free writing.

PROFINET record data (read request)	Value	Meaning
Slot	Position of the EtherCAT device (1...255)	Slot number, position of the EtherCAT device
SubSlot	1	Sub-slot number, always "1"
Index	0x200F	PROFINET index number
Length	Write 4 Answer 4 bytes + x bytes	Length of the following data
Data	Write Byte 1 "1" Byte 2 "0" Byte 3 "0" Byte 4 "0" Answer Bytes 1..4 ADS error Bytes 4..x CoE data value	CoE data

The response to the read request, i.e. the read response, includes the data. The first 4 bytes contain the error code. This is "0" if the response is error-free. The error code is an ADS error code. Further information can be found under the following link.

[http://infosys.beckhoff.com/content/1031/tcsample/html/ads\\_returncodes.htm](http://infosys.beckhoff.com/content/1031/tcsample/html/ads_returncodes.htm)

 Wireshark sample for reading (<https://infosys.beckhoff.com/content/1033/ek9300/Resources/zip/2609011595.zip>)

**Getting Started - Writing**

PROFINET record data (write request)	Value	Meaning
Slot	Position of the EtherCAT device (1...255)	Slot number, position of the EtherCAT device
SubSlot	1	Sub-slot number, always "1"
Index	0x200F	PROFINET index number
Length	4	Length of the following data
Data	Bytes 1..2 SDO index Byte 3 SDO subindex Byte 4 "1" constant Bytes 5..8 length as DWORD Bytes 9..x CoE data value	CoE data

Delay time, we recommend 250..500 ms until the read request is sent, which includes an acknowledgment of error-free writing.

PROFINET record data (read request)	Value		Meaning
Slot	Position of the EtherCAT device (1...255)		Slot number, position of the EtherCAT device
SubSlot	1		Sub-slot number, always "1"
Index	0x200F		PROFINET index number
Length	Write 0	Answer 4	Length of the following data
Data	Write -	Write ADS error code	CoE data

The response to the read request, i.e. the read response, includes confirmation that writing was successful. The first 4 bytes contain the error code; "0" indicates error-free response. The error code is an ADS error code. Further information can be found under the following link.

System docu

 Wireshark sample for writing (<https://infosys.beckhoff.com/content/1033/ek9300/Resources/zip/2609013771.zip>)

### Observe data format

 During reading and writing, observe the data size and the format of the corresponding SDO parameters. We recommend reading the SDO data first, then interpret them and use the read data format also for writing the CoE data (perhaps swap High/Low BYTE/WORD).

### Start-up parameters overwrite CoE data

 CoE data are typically not stored in the EtherCAT device. Ensure that start-up parameters (GSDML) overwrite the CoE data during startup of the EK9300.

## 5.4.2 EK9300 - multi-configuration mode

### Description

Multi-configuration mode enables users to operate different hardware, e.g. a EK9300 with varying EtherCAT Terminals, with the same project configuration.

This description uses EtherCAT Terminals (ELxxxx) in the examples. The same principle applies to EtherCAT Box modules (EPxxxx).

### Task

The machine manufacturer has a machine, which is to be sold with different options. The options are usually additional signals to be processed and logged, for which additional terminals are required.

For all these options the project configuration should be retained and only be varied via the software. The actual machine options are included in the parameterization.

### Solution

The multi-configuration mode is used to configure the maximum number of options in the project configuration. If the machine has less than the maximum number of options, EtherCAT Terminals can be omitted, since these signals are not required. Although unused EtherCAT Terminals are included in the maximum project configuration, they can be disabled by the controller, so that the hardware and the parameterized configuration match again. As soon as this is done, the EK9300 switches to normal data exchange.

## Advantage

Less effort for creating and maintaining projects, since the same project configuration can be used for different hardware.

## Sample

The standard machine configuration, without options, consists of:

- 1 x EK9300
- 2 x EL2004
- 2 x EL1004
- 1 x EL5051

The following options can be added:

- With energy monitoring for logging the energy consumption: additionally an EL3403
- With automatic adjustable axis: additionally an EL7047
- With temperature measurement: additionally an EL3314

The maximum configuration (with optional terminals shown in italics) then looks as follows:

- 1 x EK9300
- 2 x EL2004
- 2 x EL1004
- 1 x EL5051
- 1 x EL3314
- 1 x EL7047
- 1 x EL3403

It is this maximum configuration that is reflected in the hardware configuration.

If the machine is ordered without options, the terminals EL3314, EL7047 and EL3403 have to be disabled in the project configuration. The EK9300 is notified of the record data (acyclic communication) to indicate which terminals are no longer required. The terminals are identified via their position.

Without options, two EL2004 are present (at position 1 and 2), two EL1004 (at position 3 and 4) and one EL5051 (at position 5). The terminals at positions 6, 7 and 8 (optional terminals) must be disabled.

If the machine is ordered with the option "automatic adjustable axis", only terminals 6 and 8 have to be disabled.



### Position of optional terminals

Optional terminals can be connected at any position and may be disabled. They do not necessarily have to be located at the end, as shown in the example.

---

## First steps

In order to enable the EK9300 to operate in multi-configuration mode, MultiConfigurationMode must be set to "TRUE" in the DAP (device access point).

There are two possible setting options.

### Option 1

This is perhaps a version for testing, since the hardware configuration must be adjusted, which should preferably be avoided.

In the DAP there is a MultiConfigurationMode setting with the slots. Here you can disable EtherCAT Terminals, which are configured but not present.

For some PROFINET controllers this must happen on startup, while other PROFINET controllers enable it to occur at runtime, which simplifies testing significantly. Disabling/enabling of terminals at runtime is a feature of the PROFINET controller and may or may not be possible in practice, depending on the manufacturer of the PROFINET controller.

## Option 2

The configuration is sent by the PLC via the record data. Here too, the manufacturers offer different options. Contact the manufacturer of your PROFINET controller, if you have any queries.

A requirement for option 2 is that your PROFINET controller allows and supports access to the record data.

PROFINET record data (write request)	Value	Meaning
Slot*	0	Slot number, always "0"
SubSlot*	1	Sub-slot number, always "1"
Index	0#2010	PROFINET index number
Length	variable	Length of the following data
Data	Each Bus Terminal requires 2 bits: 00 <sub>bin</sub> terminal present 10 <sub>bin</sub> terminal not present	Enabling/disabling of the EtherCAT devices

\* For some PROFINET controllers these data are automatically taken from the GSDML and do not have to be configured.

## Procedure

Once the station has been configured, the following steps are required.

If the machine is ordered with the maximum configuration (with all options), generally no action is required, since the hardware matches the project configuration.

If one of the options is not included, then hardware and project planning differ. The PROFINET coupler indicates this via the message "Module difference".

Now disable the terminals, which are not present. When this is done, the message "Module Difference" is removed from the coupler. If the message "Module Difference" remains, you may have the wrong slot or too few slots disabled.

### ● No subslots

**i** Subslots are not counted and cannot be used for the multi-configuration mode. Only slots can be used, irrespective of a module using subslots or not.

### ● No Shared Device

**i** The Shared Device feature cannot be used when the multi-configuration mode is used.

### ● No pack or (\*) terminals

**i** Pack or (\*) terminals cannot be used in multi-configuration mode.

## 5.4.3 EK9300 - IO-LINK

### Description

The EK9300 (from firmware 6) supports the IO-Link master EL6224 (EtherCAT Terminal) and EP6224 (EtherCAT Box). The GSDML file (from version GSDML-V2.32-beckhoff-EK9300-20160408.xml) includes this IO-Link master. Each IO-Link device is addressed as a submodule and must be configured via the GSDML file.

## Task

Connection of an IO-Link sensor to an EK9300.

## Configuration of the process data

Each IO-Link device is added as a submodule. For each IO-Link device a submodule is used. The process data size of the submodule must always be equal to or greater than that of the IO-Link device and must not be less.

If not all IO-Link channels are used, empty channels should be entered. For example, if sensors are only connected to inputs 2 and 4 of the IO-Link master, while inputs 1 and 3 are unused, first enter an empty channel as submodule, then the sensor at input 2, then another empty channel and finally the sensor at input 4. The first submodule used by the IO-Link master is a diagnostics module. This is always present when the EL6224/EP6224 is added. This submodule contains the status of all connected IO-Link devices. If the sensor is in IO-Link data exchange, this is indicated via the corresponding byte (0x03 means all OK).

Information on the status byte:

0x\_0 = Port disabled  
0x\_1 = Port in std dig in  
0x\_2 = Port in std dig out  
0x\_3 = Port in communication OP  
0x\_4 = Port in communication COMSTOP / dig in Bit (only in std. IO Mode)  
0x\_8 = Process Data Invalid Bit  
0x1\_ = Watchdog detected  
0x2\_ = internal Error  
0x3\_ = invalid Device ID  
0x4\_ = invalid Vendor ID  
0x5\_ = invalid IO-Link Version  
0x6\_ = invalid Frame Capability  
0x7\_ = invalid Cycle Time  
0x8\_ = invalid PD in length  
0x9\_ = invalid PD out length  
0xA\_ = no Device detected  
0xB\_ = error PreOP/Data storage

Regarding the process data size of an IO-Link device, please refer to the documentation or consult the manufacturer.

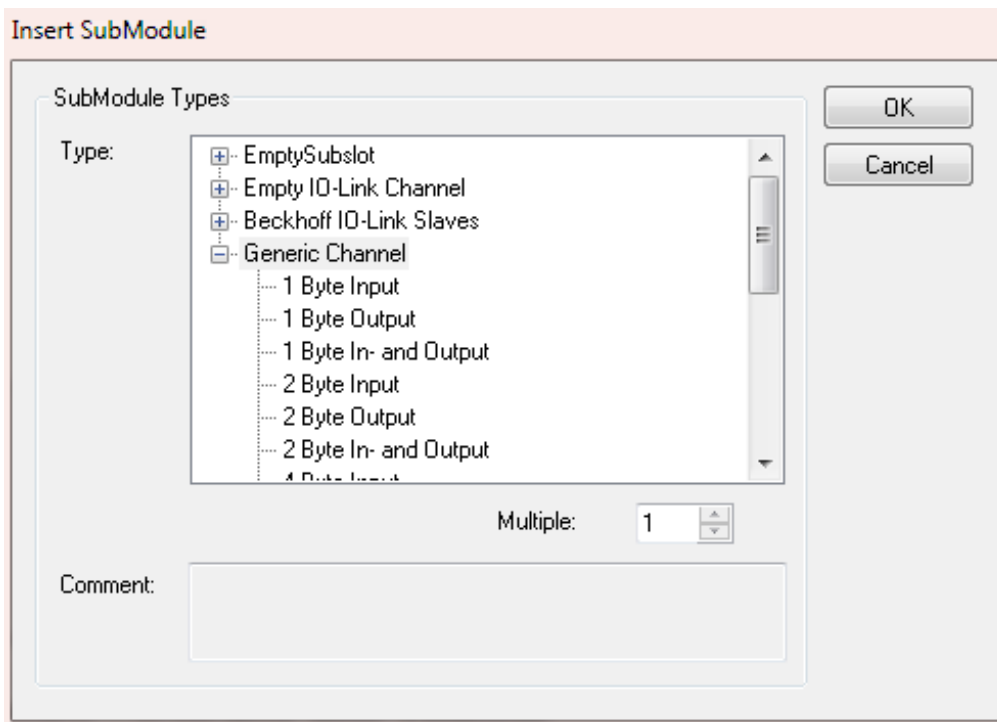

Fig. 29: Inserting a "generic channel" (in the case of IO-Link devices from other manufacturers)

IO-Link devices from Beckhoff are automatically added with the required parameters. For devices from other manufacturers please use a generic channel and select the process data size.

### Configuration of the IO-Link device

The minimum settings required for operating an IO-Link device are:

IO-Link version: Generally 1.1; enter 11

Frame capability: Generally 1

Min. cycle time: Generally 2.3 ms, i.e. 23

Process data in / Out length: Variable (number in bits), for a size of 2 bytes input enter 16 for "Process data in length".

Master control: set to IO-Link

All other settings are optional.

General		Parameterize Module			
Channel settings		Name	R/W	Offline Value	Online Value
Index 0x3000		Device ID	R/W	0	0
		Vendor ID	R/W	0	0
		IO-Link Revision	R/W	11	11
		Frame capability	R/W	1	1
		Min cycle time	R/W	23	23
		Offset time	R/W	0	0
		Process data in length	R/W	16	16
		Process data out length	R/W	0	0
		Compatible ID	R/W	0	0
		Reserved	R/W	0	0
		Master Control	R/W	IO-Link	IO-Link
		Enable Datastorage	R/W	disabled	disabled
		Enable Datastorage Upload	R/W	disabled	disabled
		Error Reaction	R/W	Freeze	Freeze

Fig. 30: Configuration of the IO-Link device

**Reading/writing of parameters**

Each IO-Link device has parameters, which can be read or written. The EK9300 does not support this function. I.e. no parameters can be read or written. The communication of the EK9300 with the IO-Link device is limited to the process data.

To access parameters of the IO-Link devices, use a Beckhoff controller (e.g. CX8093). Here you can read the IODD file (IO-Link device description) and read or write the sensor data via the PLC.

**5.5 From firmware version 8**

In order to be able to use the updated firmware version 8, you have to use the corresponding GSDM device description, from version GSDML-V2.32-beckhoff-EK9300-20170216.XML.

Add the corresponding GSDML DAP for the firmware (FW8.0).

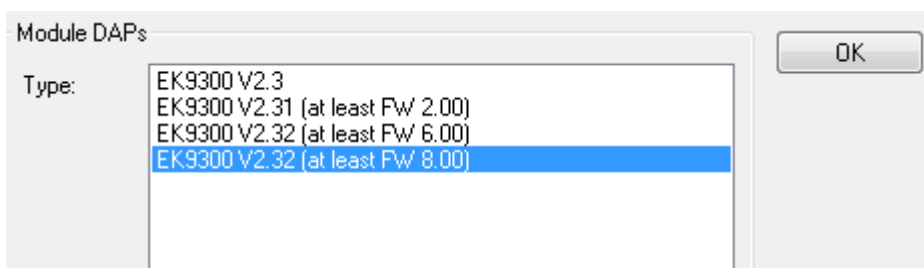

Fig. 31: Adding the GSDML DAP for firmware FW8.0

**5.5.1 EBus Error Behaviour**

The parameter *EBus error behavior* is new in firmware version 8.

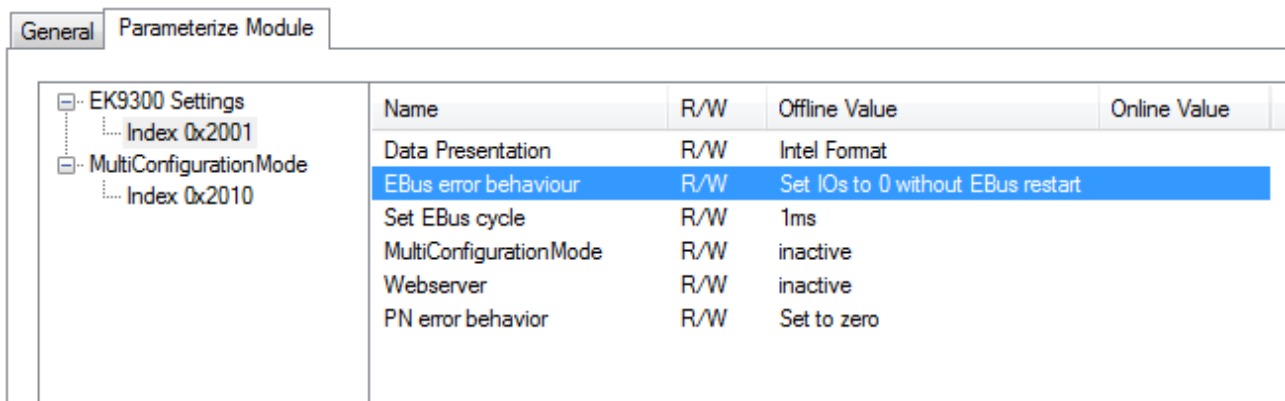

Fig. 32: The parameter EBus error behavior

This parameter is used to set the response to an E-bus error. The following options are available:

<b>Legacy</b>	Output data is still written, input data is frozen and therefore no longer current.
<b>Set IOs to 0</b>	Output data is written to zero; input data is written to zero; when the E-bus is error-free, it automatically starts the data exchange.
<b>Set IOs to 0 without EBus restart (Default setting)</b>	Output data is written to zero; input data is written to zero; when the E-bus is error-free, it can be activated again via the record data (see below).

### Activating the E-bus after an E-bus error

In the DAP, information about the E-bus is provided via the status DWord. When an error occurs in the E-bus, the bit *EcFrameError* is set (in the high word bit offset x.2). Once the error has been rectified and the coupler is ready to restart the E-bus, the bit *EcFrameError* is reset and the flag *NeedEBusRese* is set in the high word bit offset x.4.

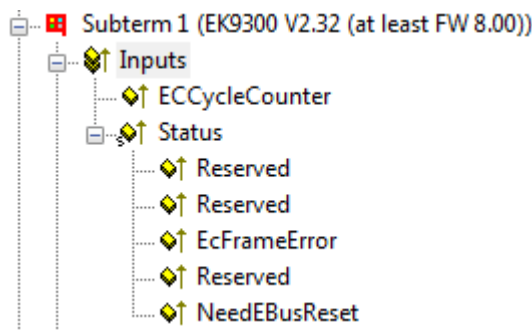

Fig. 33: Flag NeedEBusReset

The reset is issued via record data and is structured as follows.

PROFINET record data (write request)	Value	Meaning
Slot	0	Slot number
SubSlot	1	Sub slot number
Index	0x2013	Index Reset
Lenght	2	Data length
Data	0x1234	Value

Once the reset has been issued, the bit *NeedEBusReset* is reset.

### Activating the web page

The web page can be activated via the parameter data of the DAP. Set the parameter *Web server* to *active* and connect the EK9300 to your PROFINET controller. Once the connection has been established and the IP address has been received, the web page of the EK9300 can be accessed.

General		Parameterize Module																														
<div style="border: 1px solid black; padding: 5px;"> <div style="display: flex; border-bottom: 1px solid black;"> <span style="border: 1px solid black; padding: 2px 5px;">General</span> <span style="border: 1px solid black; padding: 2px 5px; margin-left: 5px;">Parameterize Module</span> </div> <div style="display: flex; border: 1px solid black; padding: 5px;"> <div style="border-right: 1px solid black; padding: 5px; width: 20%;"> <ul style="list-style-type: none"> <li>[-] EK9300 Settings               <ul style="list-style-type: none"> <li>[...] Index 0x2001</li> <li>[+] MultiConfigurationMode</li> </ul> </li> </ul> </div> <table border="1" style="width: 80%; border-collapse: collapse;"> <thead> <tr> <th style="width: 60%;">Name</th> <th style="width: 10%;">R/W</th> <th style="width: 20%;">Offline Value</th> <th style="width: 10%;"></th> </tr> </thead> <tbody> <tr> <td>Data Presentation</td> <td>R/W</td> <td>Intel Format</td> <td></td> </tr> <tr> <td>EBus error behaviour</td> <td>R/W</td> <td>Set IOs to 0 without ...</td> <td></td> </tr> <tr> <td>Set EBus cycle</td> <td>R/W</td> <td>PN cycle</td> <td></td> </tr> <tr> <td>MultiConfigurationMode</td> <td>R/W</td> <td>inactive</td> <td></td> </tr> <tr style="background-color: yellow;"> <td>Webserver</td> <td>R/W</td> <td>active</td> <td></td> </tr> <tr> <td>PN error behavior</td> <td>R/W</td> <td>Set to zero</td> <td></td> </tr> </tbody> </table> </div> </div>					Name	R/W	Offline Value		Data Presentation	R/W	Intel Format		EBus error behaviour	R/W	Set IOs to 0 without ...		Set EBus cycle	R/W	PN cycle		MultiConfigurationMode	R/W	inactive		Webserver	R/W	active		PN error behavior	R/W	Set to zero	
Name	R/W	Offline Value																														
Data Presentation	R/W	Intel Format																														
EBus error behaviour	R/W	Set IOs to 0 without ...																														
Set EBus cycle	R/W	PN cycle																														
MultiConfigurationMode	R/W	inactive																														
Webserver	R/W	active																														
PN error behavior	R/W	Set to zero																														

Fig. 34: Setting the parameter *Web server* to active

We recommend to use this web page only for diagnostic purposes and to avoid implementing settings there, since this should generally be done through the PROFINET controller.

The web page can be reached by calling the IP address of the EK9300 with the parameter *Config*

Example: 192.168.1.10 /Config

User name: guest

Password: 1

In order to access the web page, the following requirements must be met:

- The web page must have been activated via the parameter data of the EK9300.
- The PROFINET controller must have been in data exchange with the EK9300 at least once, so that the parameters and the IP address on the EK9300 are set.
- The PC with the web browser must be in the same IP segment as the EK9300. Use the PING command from the PC to check whether the PC can reach the EK9300. If this is the case, you can call up the web page of the EK9300.

If the PING command fails, check the following:

- Was the web page enabled?
- Was the communication between the PROFINET controller and the EK9300 successful?
- Is the IP address of the PC correct?



### Browser recommendation

We recommend Chrome or Firefox for displaying the web page.

# 6 Ethernet

## 6.1 PROFINET system presentation

PROFINET is the open Industrial Ethernet-standard of the PNO (PROFIBUS User Organization). PROFINET IO describes the exchange of data between controllers and field devices in several real-time classes: RT (software-based real-time) and IRT (hardware-supported isochronous real-time). In addition, further Ethernet traffic can be transmitted in the NRT (non-real-time) time slot of the PROFINET cycle. RT can be networked with commercially available switches; switches with corresponding hardware support are required for IRT.

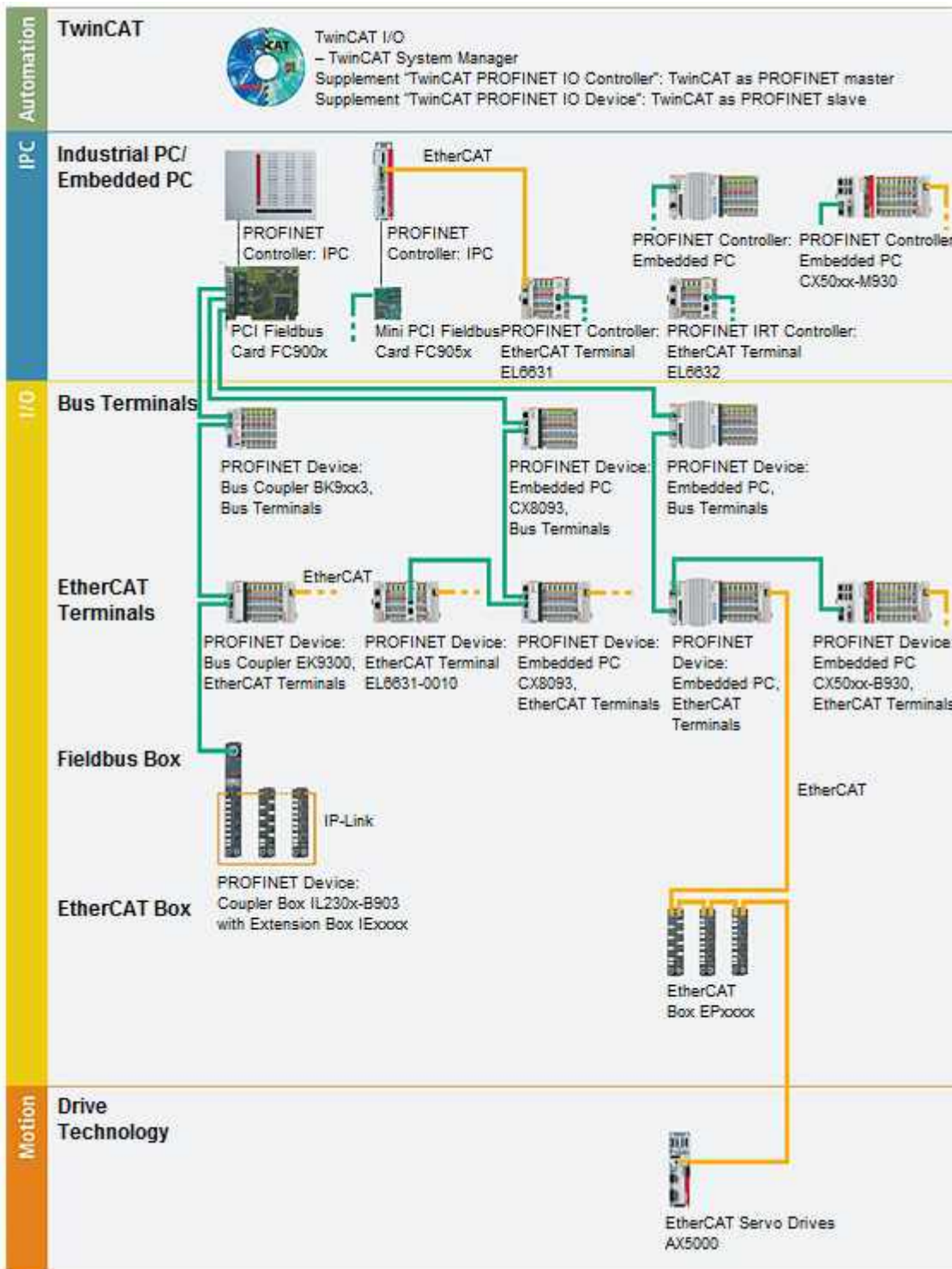

Fig. 35: PROFINET system overview

Components	Comment
<b>Embedded PCs</b>	
<a href="#">CX8093</a>	Embedded PC with PROFINET RT Device fieldbus interface
<a href="#">CX50xx-M930</a>	Embedded PC with optional interface PROFINET RT Controller
<a href="#">CX50xx-B930</a>	Embedded PC with optional PROFINET RT Device interface
<b>EtherCAT Terminals</b>	
<a href="#">EL6631</a>	PROFINET IO controller
<a href="#">EL6631-0010</a>	PROFINET IO device
<a href="#">EL6632</a>	PROFINET-IRT controller
<b>Bus Coupler</b>	
<a href="#">BK9053</a>	PROFINET "Compact" Bus Coupler for Bus Terminals
<a href="#">BK9103</a>	PROFINET Bus Coupler for Bus Terminals
<a href="#">EK9300</a>	PROFINET Bus Coupler for EtherCAT Terminals
<b>EtherCAT Box</b>	
<a href="#">EP9300</a>	PROFINET Coupler Box for EtherCAT Box Modules
<b>Fieldbus Box</b>	
<a href="#">IL230x-B903</a>	PROFINET Coupler Box for IP-Link Box Modules
<b>PC Fieldbus cards</b>	
<a href="#">FC900x</a>	PCI-Ethernet card for all Ethernet (IEEE 802.3)-based protocols
<a href="#">FC9x51</a>	Mini PCI-Ethernet card for all Ethernet (IEEE 802.3)-based protocols
<b>TwinCAT</b>	
<a href="#">TwinCAT PROFINET IO Controller</a>	TwinCAT as PROFINET master
<a href="#">TwinCAT PROFINET IO Device</a>	TwinCAT as PROFINET slave

# 7 Error handling and diagnosis

## 7.1 Diagnostic LEDs

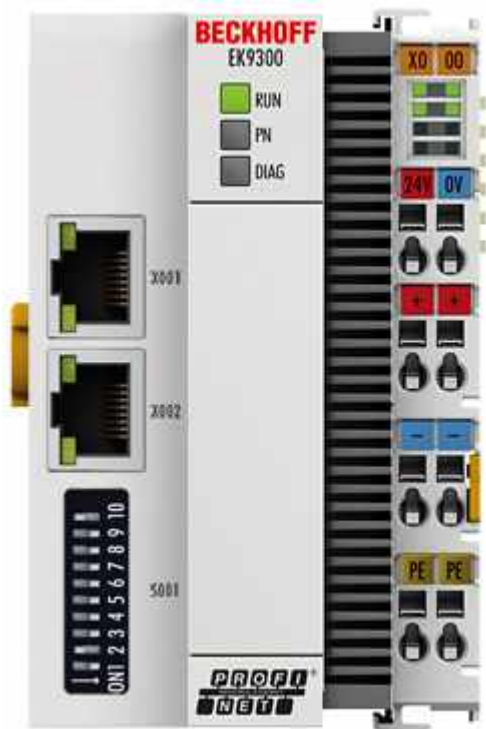

Fig. 36: EK9300 LEDs

### Ethernet interface X001

Interface X001/X002	Ethernet (CX8090)	Meaning
LED green	on	Link available/activity
LED yellow	is not used	-

### LED coupler

Labelling	Meaning	Color	Meaning
RUN	Indicates the status of the coupler	red	May only light up during the start-up phase
		Green	Coupler is ready
		Blue (If red DIP switch 1 is set to on when starting the coupler)	The internal Flash can be reached via USB (firmware update)

LED PN	PROFINET status		Meaning
	green	red	
Power On	off	200 ms flashing	Start-up phase
No name	200 ms flashing	off	no Profinet name
No IP	1 s off, 200 ms on	off	No IP address
Run	on	off	OK

LED DIAG	PROFINET diagnosis		Meaning
	green	red	
Flashing, PN controller identification	500 ms	500 ms	The PN controller is transmitting an identification signal
No AR established	off	200 ms flashing	The establishment of a connection with the controller has not been completed
Device is in IO exchange Error display of Outputs CR is set to module differences	1 s off, 200 ms on	off	Problem with establishment of a connection or nominal and actual configuration differ
Device is in IO exchange but provider is in stop	200 ms	off	Coupler is in data exchange, but PLC is in stop
Device is in IO exchange	on	off	OK

**LED power supply terminal**

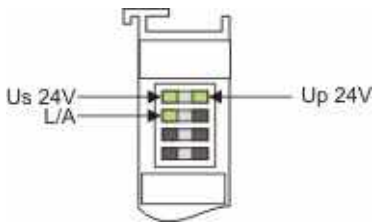

Fig. 37: LED power supply terminal

Operation with E-bus terminals

Display LED	Description	Meaning
1 Us 24 V (top left, 1 <sup>st</sup> row)	CX8000 supply voltage	on: connected to: 24 V
2 Up 24 V (top right, 1 <sup>st</sup> row)	Power contacts supply voltage	on: connected to: 24 V
3 L/A (left center, 2 <sup>nd</sup> row)	EtherCAT LED	flashing green: EtherCAT communication active on: E-bus connected / no data traffic off: E-bus not connected

## 8 Appendix

### 8.1 Update Bus Coupler image



#### Loss of data

The data in the internal flash memory are deleted.  
Save your data before you update the Bus Coupler image.

The Bus Coupler image can be updated via the USB interface. To this end the Bus Coupler is connected with a host PC via a USB cable. Windows then shows the Bus Coupler as a removable data storage device, and the files can be copied.

The Bus Coupler should only be updated after consultation with the Beckhoff Service. The Beckhoff Service will provide all the required files.

#### Requirements

- First, check whether the Bus Coupler supports the image.
- The Bus Coupler is connected with the host PC via a USB cable.

#### Update the image as follows:

1. Switch off the Bus Coupler.
2. Switch the red 2-pin **DIP switch 1** to “on” (to the right) and switch on the Bus Coupler. The Bus Coupler appears as a removable data storage device on the host PC.
3. Select and delete all files. Do not format.

	BkpcDiag	01.01.2006 11:00	Dateiordner	
	Documents and Settings	01.01.2006 11:00	Dateiordner	
	TwinCAT	01.01.2006 11:00	Dateiordner	
	NK.bin	22.05.2017 15:03	BIN-Datei	12.697 KB

4. Remove the USB cable, once all files have been copied, and switch the 2-pin DIP switch to “off” (to the left).
  5. Restart the Bus Coupler.
- ⇒ The image has been updated successfully. After the update, the Bus Coupler may take a little longer to start up.

## 8.2 EK9300 – FAQ

### How can I leave the outputs in the current state in case of a PROFINET error?

For this, two settings need to be made in the GSDML – i.e. in the configurator. First of all, "Activate PN reset value" in the DAP must be set to ON. The value "Frozen" must then be selected in the corresponding digital output terminal. The setting can only be made for a complete terminal; i.e. in the case of an EL2004 all 4 channels are then in the frozen state.

### I would like to change the mapping of an EtherCAT terminal. Why doesn't it offer me this option?

The standard mapping is always appended by default. If other mappings are possible you must first delete the standard mapping from your configurator and then insert the new submodule.

### The 2 or 4-channel digital output terminals are to be mapped to one byte. How do I do that?

The GSDML file contains the so-called "PACK" terminals. Without asterisk means that a byte is created, with asterisk that the byte is filled. Pack terminals must always be situated one behind the other (physically) and the byte may not be exceeded.

### Where can I get the GSDML file?

The GSDML file can be found at <http://www.beckhoff.de/german/download/bkconfig.htm>

### Where can I find the MAC address of the coupler?

The MAC address is printed on the label on the side of the coupler.

### What is the USB interface for and what can I do with it?

The USB interface is to be used at present only for firmware updates.

### What is the purpose of the DIP switch behind the flap?

The DIP switch is necessary, for example, for the use of the firmware update (see chapter entitled "DIP switch").

### Can I also connect K-bus terminals?

No, only EtherCAT terminals or EtherCAT boxes can be connected. You can use the BK9053 or BK9103 for K-bus terminals. The use of EtherCAT couplers for K-bus such as the BK1120 or BK1250 is not possible.

### I have an EtherCAT slave from a third-party vendor, can I also connect it?

No, devices from other vendors can only be used with a CX (see CX8093 or similar products).

### I would like to operate the drive terminals/drives on the EK9300. Is that possible?

No, use a CX with a suitable performance for this – CX9020 or higher.

### I would like to operate TwinSAFE terminals on the EK9300. Is that possible?

No, the TwinSAFE terminals require a TwinCAT system for configuration; use the CX8093 for this.

### How can I tell whether there is an EtherCAT error?

There is a Status word in the DAP of the coupler. A bit is set here if an error occurs in EtherCAT (see [Data in the DAP \[► 28\]](#)). Further information about the error can be obtained through the PROFINET alarms.

## 8.3 List of Abbreviations

### ADS

Automation Device Specification (disclosed protocol for the communication of all BECKHOFF controllers)

### DAP

Device Access Point

**I/O**

Inputs and outputs

**E-bus**

Designation for EtherCAT terminals in the terminal group (ELxxxx, ESxxxx, or EMxxxx)

**EtherCAT**

EtherCAT (Ethernet for Control Automation Technology) is the Ethernet solution for industrial automation, characterized by outstanding performance and particularly simple handling.

**Fast Ethernet**

Data rate 100 Mbits/s according to the 100 Base-T standard.

**Device name**

The device name in the case of PROFINET corresponds in type to the address in the case of Profibus. Most devices have no name at the time of the initial commissioning and must be given a name by the controller or supervisor. However, most BECKHOFF devices also enable a default name to be set by DIP switch, so that the naming of the devices is dispensed with.

**GSDML**

Basic device file for PROFINET in XML format (corresponds to the GSD file in the case of PROFIBUS).

**IP20**

Protection class of the Bus Terminals, EtherCAT Terminals

**IPC**

Industrial PC

**K-bus**

Terminal bus (KLxxxx, KMxxxx or KSxxxx terminals)

**KS2000**

Configuration software for Bus Terminals, Bus Couplers, Bus Terminal Controllers, fieldbus box modules, etc.

**PE**

The PE power contact can be used as a protective earth.

**PROFINET**

This is a further development of PROFIBUS and is based on Ethernet technology. PROFINET is described in IEC 61158.

**PROFINET IO**

This is the generic term for PROFINET communication and describes the concept.

**PROFINET controller**

This is the name for the PROFINET master for the PROFINET devices (slaves)

**PROFINET device**

This is the name for the slaves on the PROFINET controller (master)

**TwinCAT**

The Windows Control and Automation Technology, programmer and configuration tool from the BECKHOFF company.

## 8.4 Support and Service

Beckhoff and their partners around the world offer comprehensive support and service, making available fast and competent assistance with all questions related to Beckhoff products and system solutions.

### Beckhoff's branch offices and representatives

Please contact your Beckhoff branch office or representative for local support and service on Beckhoff products!

The addresses of Beckhoff's branch offices and representatives round the world can be found on her internet pages:

<http://www.beckhoff.com>

You will also find further documentation for Beckhoff components there.

### Beckhoff Headquarters

Beckhoff Automation GmbH & Co. KG

Huelshorstweg 20  
33415 Verl  
Germany

Phone:	+49(0)5246/963-0
Fax:	+49(0)5246/963-198
e-mail:	info@beckhoff.com

### Beckhoff Support

Support offers you comprehensive technical assistance, helping you not only with the application of individual Beckhoff products, but also with other, wide-ranging services:

- support
- design, programming and commissioning of complex automation systems
- and extensive training program for Beckhoff system components

Hotline:	+49(0)5246/963-157
Fax:	+49(0)5246/963-9157
e-mail:	support@beckhoff.com

### Beckhoff Service

The Beckhoff Service Center supports you in all matters of after-sales service:

- on-site service
- repair service
- spare parts service
- hotline service

Hotline:	+49(0)5246/963-460
Fax:	+49(0)5246/963-479
e-mail:	service@beckhoff.com

# List of illustrations

Fig. 1	EL5021 EL terminal, standard IP20 IO device with serial/ batch number and revision ID (since 2014/01).....	9
Fig. 2	EK1100 EtherCAT coupler, standard IP20 IO device with serial/ batch number.....	9
Fig. 3	CU2016 switch with serial/ batch number.....	9
Fig. 4	EL3202-0020 with serial/ batch number 26131006 and unique ID-number 204418 .....	10
Fig. 5	EP1258-00001 IP67 EtherCAT Box with batch number/ date code 22090101 and unique serial number 158102.....	10
Fig. 6	EP1908-0002 IP67 EtherCAT Safety Box with batch number/ date code 071201FF and unique serial number 00346070 .....	10
Fig. 7	EL2904 IP20 safety terminal with batch number/ date code 50110302 and unique serial number 00331701.....	10
Fig. 8	ELM3604-0002 terminal with unique ID number (QR code) 100001051 and serial/ batch number 44160201.....	11
Fig. 9	EtherCAT Terminals at an EKxxxx series Bus Coupler.....	12
Fig. 10	Spring contacts of the Beckhoff I/O components.....	15
Fig. 11	EK9xxx – dimensions taking the EK9300 as an example.....	16
Fig. 12	EK9300 - Snapping onto the mounting rail.....	16
Fig. 13	Recommended distances for standard installation position.....	17
Fig. 14	Other installation positions.....	18
Fig. 15	Bus Coupler EK9300 power supply.....	19
Fig. 16	RJ45 interface.....	20
Fig. 17	EK9300 - Topology sample .....	23
Fig. 18	DIP switch S001: Left off "0", right on "1".....	26
Fig. 19	Additional interfaces of the EK9xx0.....	27
Fig. 20	Inserting a sub-module .....	29
Fig. 21	Sample configuration with EK1100 EtherCAT coupler .....	31
Fig. 22	Sample configuration with EPxxxx EtherCAT Box.....	31
Fig. 23	Sample configuration with EK1122 2-port EtherCAT junction .....	32
Fig. 24	Sample configuration with EP1122 2-port EtherCAT junction .....	32
Fig. 25	EK9300 - Predefined PDO selection dialog.....	34
Fig. 26	EK9300 Sub-modules.....	34
Fig. 27	PROFINET record indices 0x3xxx (corresponds to EtherCAT objects 0x8xxx) .....	35
Fig. 28	CoE data access over PROFINET, read/write sample .....	36
Fig. 29	Inserting a "generic channel" (in the case of IO-Link devices from other manufacturers).....	42
Fig. 30	Configuration of the IO-Link device .....	43
Fig. 31	Adding the GSDML DAP for firmware FW8.0.....	43
Fig. 32	The parameter EBus error behavior .....	44
Fig. 33	Flag NeedEBusReset .....	44
Fig. 34	Setting the parameter Web server to active .....	45
Fig. 35	PROFINET system overview .....	46
Fig. 36	EK9300 LEDs .....	48
Fig. 37	LED power supply terminal.....	49