



SIRIUS SOFT STARTER, S12, 280 A,  
160 KW/400 V, 40 DEG., 200-460 V AC,  
230 V AC, SCREW TERMINALS

General details:		
<b>product brand name</b>		SIRIUS
<b>Product equipment</b>		
• integrated bridging contact system		Yes
• thyristors		Yes
<b>Product function</b>		
• intrinsic device protection		Yes
• motor overload protection		Yes
• evaluation of thermal resistor motor protection		No
• reset external		Yes
• adjustable current limitation		Yes
• inside-delta circuit		No
<b>Product component / outlet for enine brake</b>		No
<b>Reference code</b>		
• according to DIN EN 61346-2		Q
• according to DIN 40719 extended according to IEC 204-2 / according to IEC 750		G
Power Electronics:		
<b>Product designation</b>		soft starters for standard applications
Operating current		

• at 40 °C / rated value	A	280
• at 50 °C / rated value	A	248
• at 60 °C / rated value	A	215
<b>Emitted mechanical power / for three-phase servomotors</b>		
• at 230 V / at standard switching / at 40 °C		
• rated value	W	90,000
• at 400 V / at standard switching / at 40 °C		
• rated value	W	160,000
<b>yielded mechanical performance (hp) / for three-phase squirrel cage motors / at 200/208 V / at standard circuit / at 50 °C / rated value</b>	hp	75
<b>Operating frequency</b>		
• rated value	Hz	50 ... 60
<b>Relative negative tolerance / of the operating frequency</b>	%	-10
<b>Relative positive tolerance / of the operating frequency</b>	%	10
<b>Operating voltage / with standard circuit / rated value</b>	V	200 ... 460
<b>Relative negative tolerance / of the operating voltage / with standard circuit</b>	%	-15
<b>Relative positive tolerance / of the operating voltage / with standard circuit</b>	%	10
<b>Minimum load in % of I<sub>M</sub></b>	%	20
<b>Adjustable rated current / of the motor / for motor overload protection / minimum</b>	A	130
<b>Continuous operating current in % of I<sub>e</sub> / at 40°C</b>	%	115
<b>Active power loss / at operating current / at 40°C / during operating phase / typical</b>	W	90

#### Control electronics:

<b>Voltage type / of control feed voltage</b>		AC
<b>Control supply voltage frequency / 1 / rated value</b>	Hz	50
<b>Control supply voltage frequency / 2 / rated value</b>	Hz	60
<b>Relative negative tolerance / of the control supply voltage frequency</b>	%	-10
<b>Relative positive tolerance / of the control supply voltage frequency</b>	%	10
<b>Control supply voltage / 1</b>		
• at 50 Hz / for AC	V	230
• at 60 Hz / for AC	V	230
<b>Relative negative tolerance / of the control supply voltage / at 60 Hz / for AC</b>	%	-15
<b>Relative positive tolerance / of the control supply voltage / at 60 Hz / for AC</b>	%	10
<b>Type of display / for fault signal</b>		red

Mechanical design:		
<b>Size of the engine control device</b>		S12
<b>Width</b>	mm	160
<b>Height</b>	mm	230
<b>Depth</b>	mm	278
<b>Mounting type</b>		screw fixing
<b>mounting position</b>		With additional fan: With vertical mounting surface +/- 90° rotatable, with vertical mounting surface +/- 22.5° tiltable to the front and back Without additional fan: With vertical mounting surface +/- 10° rotatable, with vertical mounting surface +/- 10° t
<b>Distance, to be maintained, to the ranks assembly</b>		
• upwards	mm	100
• sideways	mm	5
• downwards	mm	75
<b>Installation altitude / at a height over sea level</b>	m	5,000
<b>Cable length / maximum</b>	m	300
<b>Number of poles / for main current circuit</b>		3





Electrical connections:		
<b>Design of the electrical connection</b>		
• for main current circuit		busbar connection
• for auxiliary and control current circuit		screw-type terminals
<b>Number of NC contacts / for auxiliary contacts</b>		0
<b>Number of NO contacts / for auxiliary contacts</b>		2
<b>Number of changeover contacts / for auxiliary contacts</b>		1
<b>Type of the connectable conductor cross-section / for main contacts / for box terminal / when using the front clamping point</b>		
• finely stranded / with conductor end processing		70 ... 240 mm <sup>2</sup>
• finely stranded / without conductor end processing		70 ... 240 mm <sup>2</sup>
• stranded		95 ... 300 mm <sup>2</sup>
<b>Type of the connectable conductor cross-section / for main contacts / for box terminal / when using the back clamping point</b>		
• finely stranded / with conductor end processing		120 ... 185 mm <sup>2</sup>
• without conductor final cutting / without conductor end processing		120 ... 185 mm <sup>2</sup>
• stranded		120 ... 240 mm <sup>2</sup>
<b>Type of the connectable conductor cross-section / for main contacts / for box terminal / when using both clamping points</b>		
• finely stranded / with conductor end processing		min. 2x 50 mm <sup>2</sup> , max. 2x 185 mm <sup>2</sup>
• without conductor final cutting / without conductor end processing		min. 2x 50 mm <sup>2</sup> , max. 2x 185 mm <sup>2</sup>

<ul style="list-style-type: none"> <li>• stranded</li> </ul>		max. 2x 70 mm <sup>2</sup> , max. 2x 240 mm <sup>2</sup>
<b>Type of the connectable conductor cross-section / for AWG conductors / for main contacts / for box terminal</b> <ul style="list-style-type: none"> <li>• when using the back cl</li> <li>• when using the front c</li> <li>• when using both clampi</li> </ul>		250 ... 500 kcmil 3/0 ... 600 kcmil min. 2x 2/0, max. 2x 500 kcmil
<b>Type of the connectable conductor cross-section / for DIN cable lug / for main contacts</b> <ul style="list-style-type: none"> <li>• finely stranded</li> <li>• stranded</li> </ul>		50 ... 240 mm <sup>2</sup> 70 ... 240 mm <sup>2</sup>
<b>Type of the connectable conductor cross-section</b> <ul style="list-style-type: none"> <li>• for AWG conductors / for main contacts</li> </ul>		2/0 ... 500 kcmil
<b>Type of the connectable conductor cross-section</b> <ul style="list-style-type: none"> <li>• for auxiliary contacts               <ul style="list-style-type: none"> <li>• solid</li> <li>• finely stranded / with conductor end processing</li> </ul> </li> <li>• for AWG conductors / for auxiliary contacts               <ul style="list-style-type: none"> <li>• finely stranded / with wire end proc</li> </ul> </li> </ul>		2x (0.5 ... 2.5 mm <sup>2</sup> ) 2x (0.5 ... 1.5 mm <sup>2</sup> ) 2x (20 ... 14) 2x (20 ... 16)

#### Ambient conditions:

<b>Ambient temperature</b> <ul style="list-style-type: none"> <li>• during operating</li> <li>• during storage</li> </ul>	°C	-25 ... +60
	°C	-40 ... +80
<b>Derating temperature</b>	°C	40
<b>Protection class IP</b>		IP00

#### Certificates/approvals:

General Product Approval		EMC	For use in hazardous locations
 CCC	 CSA		 UL
		 C-TICK	 ATEX
Test Certificates	Shipping Approval	other	
<a href="#">Special Test Certificate</a>	 DNV	 GL	 LRS
		<a href="#">Declaration of Conformity</a>	<a href="#">Environmental Confirmations</a>

#### UL/CSA ratings

<b>yielded mechanical performance (hp) / for three-phase squirrel cage motors</b> <ul style="list-style-type: none"> <li>• at 220/230 V / at standard circuit</li> <li>• at 50 °C / rated value</li> </ul>	hp	100
--	----	-----

- at 460/480 V / at standard circuit
- at 50 °C / rated value

hp

200

**Contact rating designation / for auxiliary contacts / according to UL**

B300 / R300

#### Further information:

**Information- and Downloadcenter (Catalogs, Brochures,...)**

<http://www.siemens.com/industrial-controls/catalogs>

**Industry Mall (Online ordering system)**

<http://www.siemens.com/industrial-controls/mall>

**CAX-Online-Generator**

<http://www.siemens.com/cax>

**Service&Support (Manuals, Certificates, Characteristics, FAQs,...)**

<http://support.automation.siemens.com/WW/view/en/3RW4074-6BB44/all>

**Image database (product images, 2D dimension drawings, 3D models, device circuit diagrams, ...)**

[http://www.automation.siemens.com/bilddb/cax\\_en.aspx?mlfb=3RW4074-6BB44](http://www.automation.siemens.com/bilddb/cax_en.aspx?mlfb=3RW4074-6BB44)

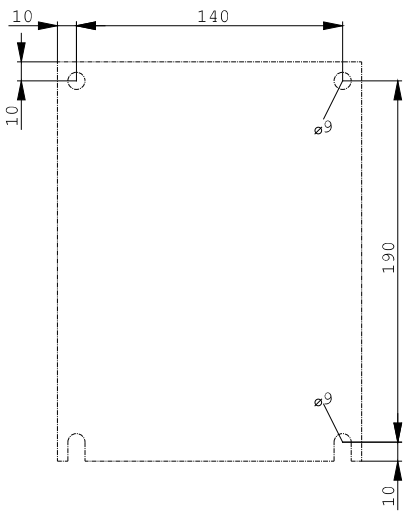
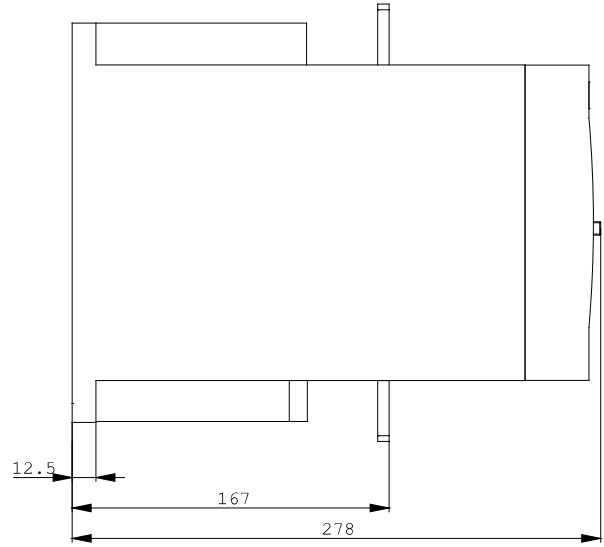
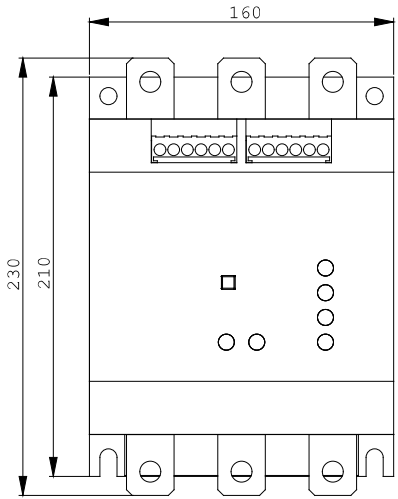

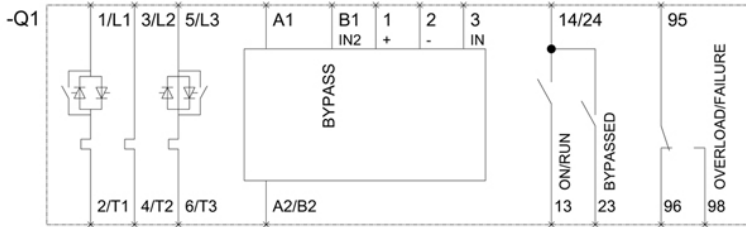

last change:

Jul 7, 2014