



Analog signal converters

CC range

Serial data converters

ILPH range

Content

Analogue Signal Converters CC-range

Benefits and advantages.....	5/ 4
Application	5/ 5
Approvals and marks	5/ 5
Ordering details	
Analog standard signal converters	
CC-E/STD, CC-E x/x	5/ 6
CC-E I/I.....	5/ 7
CC-U/STD	5/ 8
CC-U/STDR.....	5/ 9
Temperature signal converters for RTD sensors	
CC-E/RTD.....	5/10
CC-U/RTD	5/11
CC-U/RTDR.....	5/12
Temperature signal converters for thermocouples	
CC-E/TC.....	5/13
CC-U/TC.....	5/14
CC-U/TCR.....	5/15
Measuring converters for currents (E/I) and (U/I) and voltages (U/V)	
CC-E/I.....	5/16
CC-E I _{AC} / ILPO.....	5/17
CC-U/I	5/18
CC-U/V	5/19
Accessories.....	5/20
Technical data	
CC-E/STD, CC-E x/x, CC-E/RTD, CC-E/TC.....	5/21
CC-E I/I	5/22
CC-U/STD, CC-U/RTD, CC-U/TC	5/23
CC-U/STDR, CC-U/RTDR, CC-U/TCR.....	5/24
CC-E/I, CC-E I _{AC} / ILPO	5/25
CC-U/I, CC-U/V	5/26
Technical diagrams.....	5/27
Connection diagrams.....	5/27
Dimensional drawings	5/27

5

Serial data converters ILPH range

Uses	5/30
Selection table.....	5/31
Ordering details	5/32
Technical data	5/32

Analog signal converters

CC range

Benefits and advantages



5

Product range for analog signal processing

CC-U range

- 8 different standard signal outputs on one device
- Input and output side universally configurable
- Also available with 2 threshold relay outputs
- Adjustment and operating elements on the front side
- Safe operation by electrical 3-way isolation
- Plug-in connecting terminals, unambiguously and clearly marked

Conversion, measurement and separation of

- standard signals
- signals of RTD sensors (PT10, PT100, PT1000)
- thermocouple signals
- RMS values of currents and voltages

Characteristics

- The required input and output ranges can be configured for all devices by means of directly accessible DIP switches positioned on the side.
- Due to the wide input range of the gain and offset stages all input signals between the minimum and the maximum input value can be universally converted to all common output signals.
- Devices for DC or AC (50/60 Hz) supply available.

CC-E range

- Universally configurable devices and single-function devices
- Adjustment and operating elements on the front side
- Safe operation by electrical 3-way isolation
- Unambiguous and clear connecting terminal markings

Conversion, measurement and separation of

- standard signals (0-5 V, 0-10 V, 0-20 mA, 4-20 mA)
- temperature signals of RTD sensors (PT 100)
- thermocouple signals (types J and K)
- current measurement signals (0-5 A, 0-20 A AC/DC)

Characteristics of single-function devices

- No adjustment or balancing necessary.

Characteristics of universal devices

- The required input and output ranges can be configured by means of directly accessible DIP switches positioned on the side
- Gain adjustment of $\pm 5\%$ by means of an adjustment potentiometer on the front-side
- Offset adjustment of $\pm 5\%$ by means of adjustment potentiometers on the front-side



2CDC 283 016 F0603

Analog signal converters

CC range

Application, Approvals and marks

Applications for analog signal processing and correct solution using CC-E and CC-U converters

Nearly every process includes a control system that receives data by means of analog signals and then evaluates the data and sets the respective parameters correspondingly.

When transmitting analog signals numerous problems may arise which can disturb or even block an ideal behavior of the process.

Below we have listed some processing problems together with the respective solutions to solve these problems:

Signal conversion

Sometimes the available signals cannot be processed by the controller. In this case, signal converters are required to convert the input signal (or different input signals) to the desired output signal.

Signal amplification

If long lines or high burdens have to be operated, it may be necessary to amplify the signal. CC analog signal converters require only low input power and provide high output power.

Thus, there are no restrictions for the converter's position on the line, i.e. it can be used

- for signal refreshing ① at the end of the line (low input power)
- or for signal amplification ② at the beginning of the line (high output power).

Signal filtering

Particularly on long lines or in rough industrial environments the signals are exposed to high electromagnetic interferences. The frequency of the coupled interference signals may be in the range of the common mains frequency (50 Hz) or even much higher (in case of frequency converters). According to the specific requirements, analog signal converters are available which provide reliable suppression of those interferences by means of an input low-pass filter.

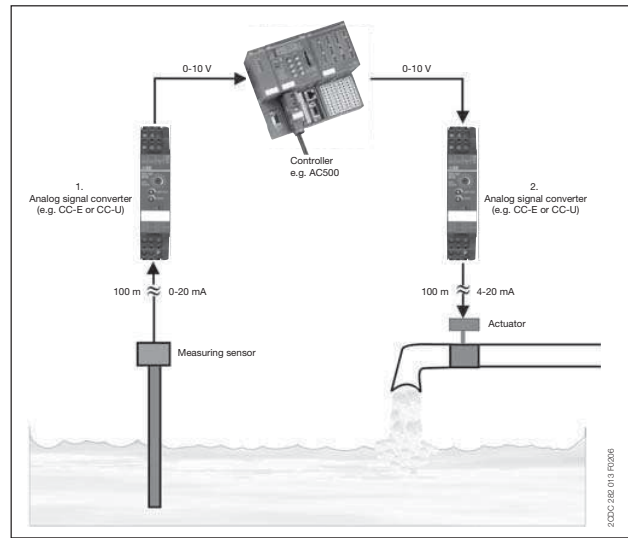

Signal separation

■ Protection against overvoltage

The increased use of micro-electronics make controls much more sensitive against overvoltages, resulting from lightning discharges or switching processes. Suppression diodes are incorporated in the input of the CC analog signal converters which enable the converters to arrest overvoltages with low energy level (resulting from switching processes) by themselves. The products furthermore provide electrical isolation between input, output and supply circuit for protection of the controller connected to the output.

■ Protection against ground loops

If components are used which refer to ground, the measuring signals can be falsified by a so-called ground loop. In this case, certain parts of the signal are transmitted via earth and not via the analog transmission line, thus causing incorrect evaluation of the signal. The electrical isolation between the input and the output disconnects these ground loops and thus enables correct signal transmission.

- existing
- ▲ existing for some devices
- pending

		CC-E/STD	CC-E/I	CC-U/STD	CC-U/STDR	CC-E/RTD	CC-U/RTD	CC-U/RTDR	CC-E/TC	CC-U/TC	CC-U/TCR	CC-E/I	CC-E I _{Ac} /ILPO	CC-U/I	CC-U/V
Approvals															
	UL 508, CAN/CSA C22.2 No.14	■	■	■	■	■	■	■	■	■	■	■	■	■	■
	UL 1604 (Class I, Div 2, hazardous locations), CAN/CSA C22.2 No.213	▲		■		▲	■		▲	■		▲		■	■
	CB scheme				■			■			■				
	CCC				■			■			■				
Marks															
	CE	■	■	■	■	■	■	■	■	■	■	■	■	■	■
	C-Tick	■	■	■	■	■	■	■	■	■	■	■	■	■	■

Analog standard signal converters

CC-E/STD, CC-E x/x

Ordering details

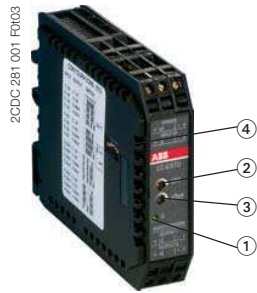

CC-E/STD



CC-E V/V

- ① U: green LED - supply voltage
- ② Gain adjustment
- ③ Offset adjustment
- ④ DIP switch for input and output configuration (only available on universal devices)

CC-E/STD analog signal converter with 3-way electrical isolation

- 2 universally configurable devices (type CC-E/STD)
- 2x10 single-function devices
- "Plug and Work", no adjustment of single-function devices required

Wiring instruction

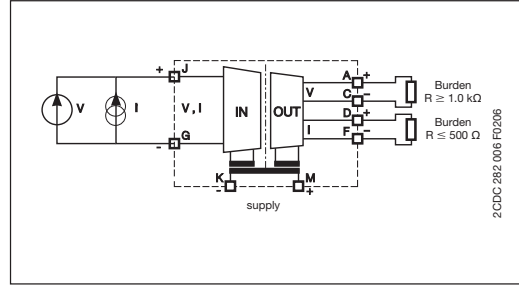

DIP switch settings (universal devices)

Input	Output	Switch							
		1	2	3	4	5	6	7	8
0...5 V	0...5 V								
	0...10 V								
	0...20 mA								
0...10 V	4...20 mA								
	0...5 V								
	0...10 V								
0...20 mA	0...20 mA								
	4...20 mA								
	0...5 V								
4...20 mA	0...10 V								
	0...20 mA								
	4...20 mA								

Type	Input signal	Output signal	Order code	Pack. unit piece	Price 1 piece
------	--------------	---------------	------------	------------------	---------------

Supply voltage: 24 V DC universal

CC-E/STD	0-5 V, 0-10 V 0-20 mA, 4-20 mA	0-5 V, 0-10 V 0-20 mA, 4-20 mA	1SVR 011 700 R0000 ¹⁾	1	
----------	-----------------------------------	-----------------------------------	----------------------------------	---	--

single-function

CC-E V/V		0-10 V	1SVR 011 710 R2100	1	
CC-E V/I	0-10 V	0-20 mA	1SVR 011 711 R1600	1	
CC-E V/I		4-20 mA	1SVR 011 712 R1700	1	

CC-E I/V		0-10 V	1SVR 011 713 R1000	1	
CC-E I/I	0-20 mA	0-20 mA	1SVR 011 714 R1100	1	
CC-E I/I		4-20 mA	1SVR 011 715 R1200	1	

CC-E I/V		0-10 V	1SVR 011 716 R1300	1	
CC-E I/I	4-20 mA	0-20 mA	1SVR 011 717 R1400	1	
CC-E I/I		4-20 mA	1SVR 011 718 R2500	1	

CC-E V/V	-10...+10 V	-10...+10 V	1SVR 011 719 R2600	1	
----------	-------------	-------------	--------------------	---	--

Supply voltage: 110-240 V AC universal

CC-E/STD	0-5 V, 0-10 V 0-20 mA, 4-20 mA	0-5 V, 0-10 V 0-20 mA, 4-20 mA	1SVR 011 705 R2100	1	
----------	-----------------------------------	-----------------------------------	--------------------	---	--

single-function

CC-E V/V		0-10 V	1SVR 011 720 R2300	1	
CC-E V/I	0-10 V	0-20 mA	1SVR 011 721 R1000	1	
CC-E V/I		4-20 mA	1SVR 011 722 R1100	1	

CC-E I/V		0-10 V	1SVR 011 723 R1200	1	
CC-E I/I	0-20 mA	0-20 mA	1SVR 011 724 R1300	1	
CC-E I/I		4-20 mA	1SVR 011 725 R1400	1	

CC-E I/V		0-10 V	1SVR 011 726 R1500	1	
CC-E I/I	4-20 mA	0-20 mA	1SVR 011 727 R1600	1	
CC-E I/I		4-20 mA	1SVR 011 728 R2700	1	

CC-E V/V	-10...+10 V	-10...+10 V	1SVR 011 729 R2000	1	
----------	-------------	-------------	--------------------	---	--

¹⁾ UL 1604 Class I, Div.2 (universal device)

Current/current isolator CC-E I/I-1 and CC-E I/I-2

Ordering details

2CDC 281 001 F0606



CC-E I/I-1

2CDC 281 041 F0603



CC-E I/I-2

Loop-powered current/current isolator without external power supply for analog current signals of 0-20 mA and 4-20 mA

- Electrical isolation between input and output
- Very low internal voltage drop ≤ 2.5 V
- Available with one or two independent channels
- Width only 18 mm (1 and 2 channels)

Wiring instructions

CC-E I/I-1

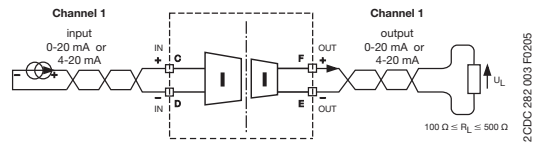

CC-E I/I-2

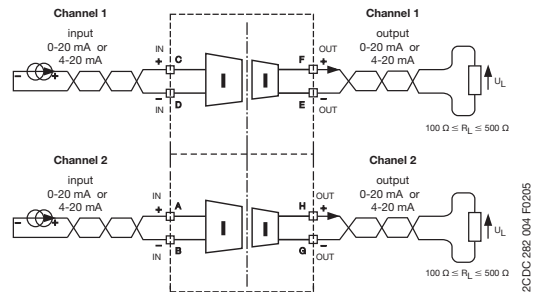

Type	Input signal	Output signal	Order code	Pack. unit piece	Price 1 piece
1 channel					
CC-E I/I-1	0-20 mA, 4-20 mA	0-20 mA, 4-20 mA	1SVR 010 200 R1600	1	
2 channel					
CC-E I/I-2	0-20 mA, 4-20 mA	0-20 mA, 4-20 mA	1SVR 010 201 R0300	1	

• Technical data 5/21 • Dimensional drawings 5/27

Analog standard signal converter CC-U/STD

Ordering details

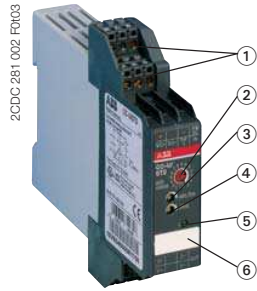

CC-U/STD

- ① Plug-in terminals
- ② Gain: Coarse adjustment
- ③ Gain: Fine adjustment
- ④ Offset adjustment
- ⑤ U: green LED - supply voltage
- ⑥ Marker label

CC-U/STD universal signal converter with 3-way electrical isolation

- More than 120 configurations possible
- Configurable output signal response on input voltage signal interruption (low fail safe / high fail safe)
- Adjustment and operating elements on the front
- Short-circuit proof signal outputs
- Plug-in connecting terminals for inputs, outputs and supply
- Very fast signal transmission enables use in control systems

Wiring instruction

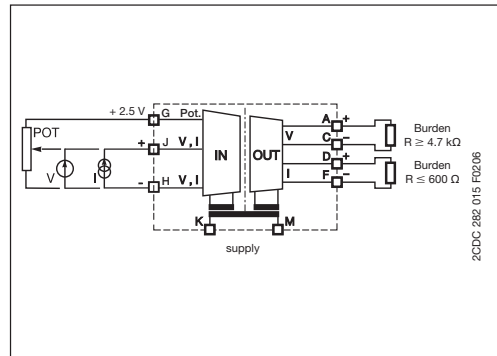

Adjustment range

Continuously variable adjustment range:

Example ①:
Input configuration: 0...10 V
Output configuration: -5...5 V

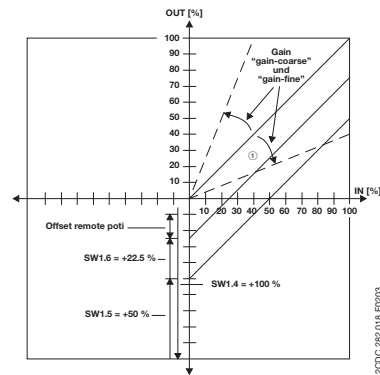

DIP switch settings

Input	Switch 1								Gain	Coarse Type
	1	2	3	4	5	6	7	8		
Potentiometer									0	0
0...50 mV									A..D	C
0...100 mV									4..5	5
0...250 mV									0..1	1
0...500 mV									7..9	8
0...1 V									3..4	3
0...2.5 V									0	0
0...5 V									5..7	6
0...10 V									2	2
1...5 V									7..9	8
2...10 V									2..4	3
-10...+10 V									0	0
0...125 mV									3..4	3
0...8 V									3..4	3
-22.5...+22.5 mV									B..F	D
-11...+11 V									0	0
2.5...7.5 V									5..7	6
3.33...9.99 V									3..4	4
10...0 V									2	2
100...0 mV									4..5	5
0...1 mA									A..D	B
0...20 mA									2..4	3
4...20 mA									4..5	4
10...50 mA									0..1	1
20...4 mA									4..5	4
20...0 mA									4..2	3
0.45...+0.45 mA									B..F	D
-55...+55 mA									4..6	5
High fail safe *)									-	-
Low fail safe *)									-	-
No fail safe *)									-	-

Output	Switch 2					
	1	2	3	4	5	6
0...5 V						
0...10 V						
1...5 V						
2...10 V						
-10...+10 V						
-5...+5 V						
-10...0 V						
-5...0 V						
0...6.66 V						
-10...+3.33 V						
-5...+1.66 V						
0...8 V						
0...4 V						
-10...-2 V						
-5...-1 V						
1.25...6.25 V						
-7.5...+2.5 V						
-3.75...+1.25 V						
1.66...8.33 V						
-6.66...+6.66 V						
-3.33...+3.33 V						
-8...0 V						
-4...0 V						
0...1 mA						
0...20 mA						
4...20 mA						
0...10 mA						
0...0.5 mA						
0...13.33 mA						
0...866 µA						
0...16 mA						
0...800 µA						
0...8 mA						
0...400 µA						
2.5...12.5 mA						
125...625 µA						
3.33...16.66 mA						
166...833 µA						
0.2...1 mA						
2...10 mA						
100...500 µA						

*) Detection of input voltage signal interruptions:
If the input signal circuit is interrupted, the output signal changes to the adjusted minimum value (low fail safe) or maximum value (high fail safe).
If "No fail safe" is configured, input signal interruptions are not detected.

Type	Rated supply voltage	Order code	Pack. unit pieces	Price 1 piece
CC-U/STD	24-48 V DC 110-240 V AC	1SVR 040 000 R1700 1SVR 040 001 R0400	1 1	

- Accessories 5/20
- Technical data 5/21
- Dimensional drawings 5/27

Analog standard signal converter CC-U/STDR with relay output

Ordering details

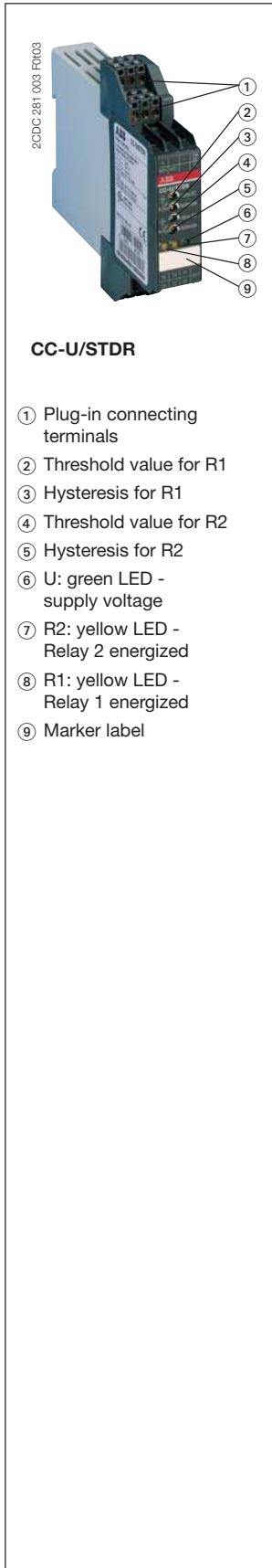

CC-U/STDR universal signal converter for standard signals, with 2 threshold relay outputs and with 3-way electrical isolation

- Standard signal converter with 7 setting ranges
- 2 threshold relay outputs with one c/o contact each (threshold and respective hysteresis can be adjusted independently from each other)
- Open-circuit or closed-circuit principle configurable by means of a DIP switch
- 2 yellow LEDs for clear status indication of the output relays
- Plug-in connecting terminals for inputs, outputs and supply

Wiring instruction

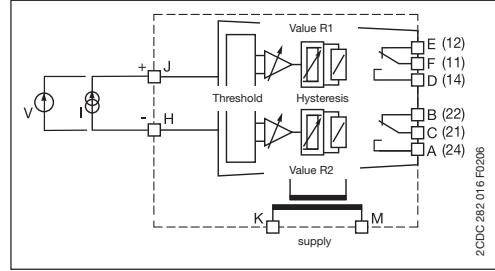

Function diagrams

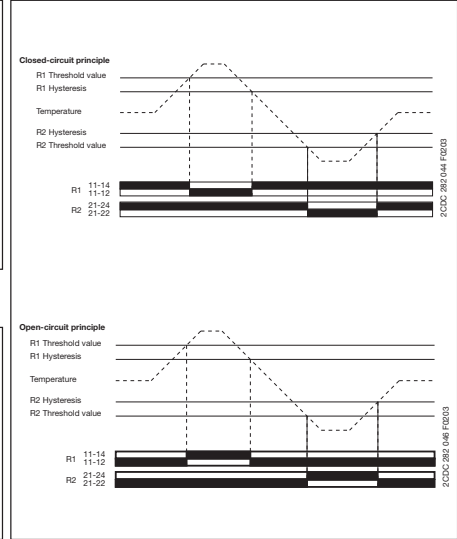

DIP switch settings

Input	Switch					
	1	2	3	4	5	6
0...0 V						
0...5 V						
0...1 V						
-10...+10 V						
1...5 V						
0...20 mA						
4...20 mA						
Output						
Closed-circuit principle						
Open-circuit principle						

2CDC 282 005 F0204

2CDC 282 005 F0204

Legend
 ■ ON
 □ OFF
 ◻ no influence

Switching points

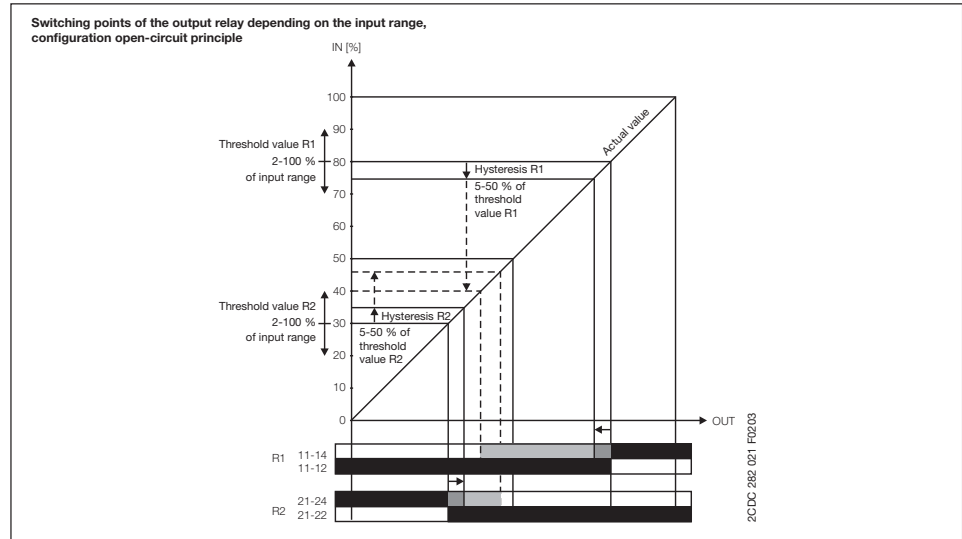

Type	Rated supply voltage	Order code	Pack. unit pieces	Price 1 piece
CC-U/STDR	24-48 V DC	1SVR 040 010 R0000	1	
	110-240 V AC	1SVR 040 011 R2500	1	

- Accessories 5/20
- Technical data 5/21
- Technical diagrams 5/27
- Dimensional drawings 5/27

Temperature signal converter for RTD sensors CC-E/RTD

Ordering details

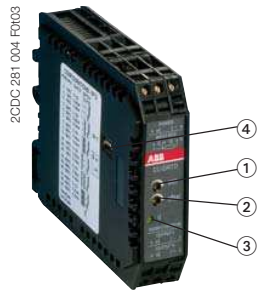

CC-E/RTD

- ① Gain adjustment
- ② Offset adjustment
- ③ U: green LED - supply voltage
- ④ DIP switch for input and output configuration (only available on universal devices)

CC-E/RTD temperature signal converter for RTD sensors, linearized with 3-way electrical isolation

- 2 universally configurable devices (type CC-E/RTD)
- 2x12 single-function devices
- "Plug and Work", no adjustment of single-function devices required
- Temperature signal converter for PT100 sensors
- 2- or 3-wire connection

Wiring instruction

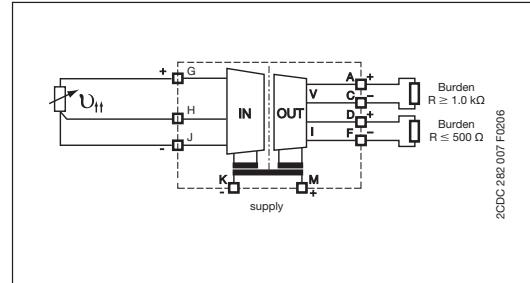

DIP switch settings (universal devices)

Input	Output	Switch					
		1	2	3	4	5	6
0...100 °C	0...10 V						
	0-20 mA						
	4-20 mA						
0...300 °C	0-10 V						
	0-20 mA						
	4-20 mA						
0...500 °C	0-10 V						
	0-20 mA						
	4-20 mA						
-50...+50 °C	0-10 V						
	0-20 mA						
	4-20 mA						
-50...+250 °C	0-10 V						
	0-20 mA						
	4-20 mA						
-50...+450 °C	0-10 V						
	0-20 mA						
	4-20 mA						
High fail safe							
Low fail safe							

Type	Input signal	Output signal	Order code	Pack. unit piece	Price 1 piece
------	--------------	---------------	------------	------------------	---------------

Supply voltage: 24 V DC universal

CC-E/RTD	refer to table	0-10 V, 0-20 mA, 4-20 mA	1SVR 011 701 R2500 ¹⁾	1	
----------	----------------	--------------------------	----------------------------------	---	--

single-function

CC-E RTD/V	PT100	0-10 V	1SVR 011 730 R2500	1	
CC-E RTD/I	0...100 °C	0-20 mA	1SVR 011 731 R1200	1	
CC-E RTD/I		4-20 mA	1SVR 011 732 R1300	1	
CC-E RTD/V	PT100	0-10 V	1SVR 011 733 R1400	1	
CC-E RTD/I	-50...+50 °C	0-20 mA	1SVR 011 734 R1500	1	
CC-E RTD/I		4-20 mA	1SVR 011 735 R1600	1	
CC-E RTD/V	PT100	0-10 V	1SVR 011 736 R1700	1	
CC-E RTD/I	0...300 °C	0-20 mA	1SVR 011 737 R1000	1	
CC-E RTD/I		4-20 mA	1SVR 011 738 R2100	1	
CC-E RTD/V	PT100	0-10 V	1SVR 011 739 R2200	1	
CC-E RTD/I	-50...+250 °C	0-20 mA	1SVR 011 740 R0700	1	
CC-E RTD/I		4-20 mA	1SVR 011 741 R2400	1	

Supply voltage: 110-240 V AC universal

CC-E/RTD	refer to table	0-10 V, 0-20 mA, 4-20 mA	1SVR 011 706 R2200	1	
----------	----------------	--------------------------	--------------------	---	--

single-function

CC-E RTD/V	PT100	0-10 V	1SVR 011 788 R2400	1	
CC-E RTD/I	0...100 °C	0-20 mA	1SVR 011 789 R2500	1	
CC-E RTD/I		4-20 mA	1SVR 011 790 R2200	1	
CC-E RTD/V	PT100	0-10 V	1SVR 011 791 R1700	1	
CC-E RTD/I	-50...+50 °C	0-20 mA	1SVR 011 792 R1000	1	
CC-E RTD/I		4-20 mA	1SVR 011 793 R1100	1	
CC-E RTD/V	PT100	0-10 V	1SVR 011 794 R1200	1	
CC-E RTD/I	0...300 °C	0-20 mA	1SVR 011 795 R1300	1	
CC-E RTD/I		4-20 mA	1SVR 011 796 R1400	1	
CC-E RTD/V	PT100	0-10 V	1SVR 011 797 R1500	1	
CC-E RTD/I	-50...+250 °C	0-20 mA	1SVR 011 798 R2600	1	
CC-E RTD/I		4-20 mA	1SVR 011 799 R2700	1	

¹⁾ UL 1604 Class I, Div.2 (universal device)

Temperature signal converter for RTD sensors CC-U/RTD

Ordering details

2CDC 281 005 F0103

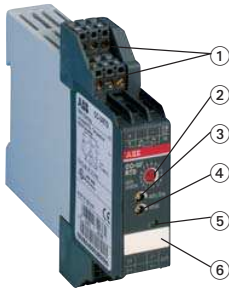

CC-U/RTD

- ① Plug-in connecting terminals
- ② Gain: Coarse adjustment
- ③ Gain: Fine adjustment
- ④ Offset adjustment
- ⑤ U: green LED - supply voltage
- ⑥ Marker label

CC-U/RTD universal signal converter for PT10, PT100, PT1000 temperature sensors (acc. to IEC 751 and JIS C 1604¹⁾, linearized with 3-way electrical isolation

- Configurable output signal response on input signal interruption (low / high fail safe)
- Adjustment and operating elements on the front-side
- Short-circuit proof signal outputs
- Plug-in connecting terminals for inputs, outputs and supply
- 2- or 3-wire connection

¹⁾ Japanese standard

Wiring instruction

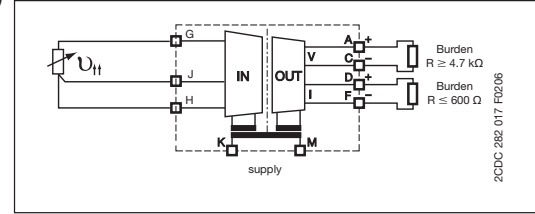

Characteristic curves

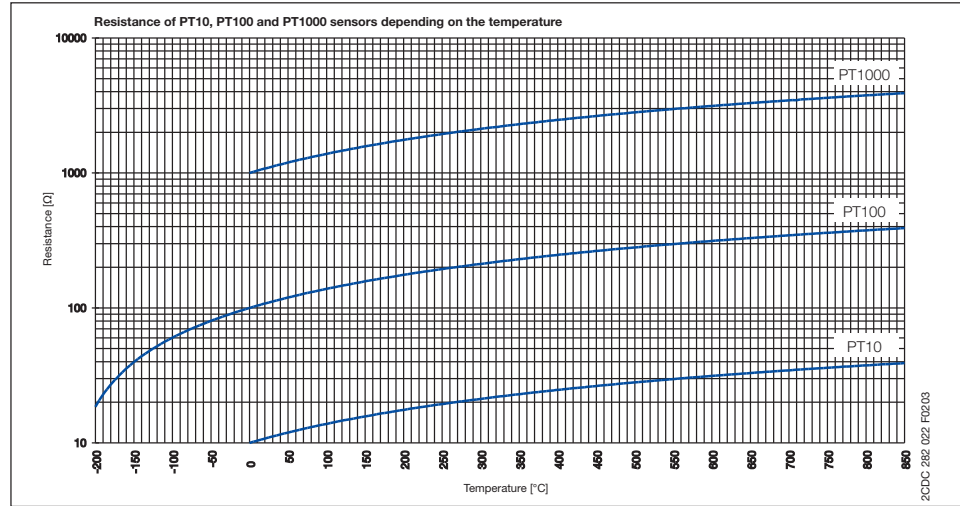

DIP switch settings

Input Type	Range	Switch 1						Switch 2						Gain Coarse
		1	2	3	4	5	6	1	2	3	4	5	6	
PT10	0...500 °C	■						■	■	■	■	■	■	F
	0...550 °C	■						■	■	■	■	■	■	E
	0...600 °C	■						■	■	■	■	■	■	D
	0...650 °C	■						■	■	■	■	■	■	C
	0...700 °C	■						■	■	■	■	■	■	B
	0...750 °C	■						■	■	■	■	■	■	A
PT100	0...800 °C	■						■	■	■	■	■	■	9
	0...850 °C	■						■	■	■	■	■	■	8
	0...50 °C	■						■	■	■	■	■	■	F
	0...60 °C	■						■	■	■	■	■	■	E
	0...70 °C	■						■	■	■	■	■	■	B
	0...80 °C	■						■	■	■	■	■	■	A
PT1000	0...90 °C	■						■	■	■	■	■	■	9
	0...100 °C	■						■	■	■	■	■	■	8
	0...200 °C	■						■	■	■	■	■	■	3
	0...300 °C	■						■	■	■	■	■	■	2
	0...400 °C	■						■	■	■	■	■	■	1
	0...500 °C	■						■	■	■	■	■	■	0
Low fail safe *)	0...10 °C	■						■	■	■	■	■	■	8
	0...20 °C	■						■	■	■	■	■	■	3
	0...30 °C	■						■	■	■	■	■	■	2
High fail safe *)	0...40 °C	■						■	■	■	■	■	■	1
	0...50 °C	■						■	■	■	■	■	■	0
	0...60 °C	■						■	■	■	■	■	■	0

*) Detection of input signal interruptions:
If the input signal circuit is interrupted, the output signal changes to the adjusted minimum value (low fail safe) or maximum value (high fail safe).

Output	Switch 3				
	1	2	3	4	5
0...5 V	■	■	■	■	■
0...10 V	■	■	■	■	■
1...5 V	■	■	■	■	■
2...10 V	■	■	■	■	■
-10...+10 V	■	■	■	■	■
-5...+5 V	■	■	■	■	■
-10...0 V	■	■	■	■	■
-5...0 V	■	■	■	■	■
0...6.66 V	■	■	■	■	■
-10...+3.33 V	■	■	■	■	■
-5...+1.66 V	■	■	■	■	■
0...8 V	■	■	■	■	■
0...4 V	■	■	■	■	■
-10...-2 V	■	■	■	■	■
-5...-1 V	■	■	■	■	■
1.25...6.25 V	■	■	■	■	■
-7.5...+2.5 V	■	■	■	■	■
-3.75...+1.25 V	■	■	■	■	■
1.66...8.33 V	■	■	■	■	■
-6.66...+6.66 V	■	■	■	■	■
-3.33...+3.33 V	■	■	■	■	■
-8...0 V	■	■	■	■	■
-4...0 V	■	■	■	■	■
0...1 mA	■	■	■	■	■
0...20 mA	■	■	■	■	■
4...20 mA	■	■	■	■	■
0...10 mA	■	■	■	■	■
0...0.5 mA	■	■	■	■	■
0...13.33 mA	■	■	■	■	■
0...666 μA	■	■	■	■	■
0...16 mA	■	■	■	■	■
0...800 μA	■	■	■	■	■
0...8 mA	■	■	■	■	■
0...400 μA	■	■	■	■	■
2.5...12.5 mA	■	■	■	■	■
1.25...6.25 μA	■	■	■	■	■
3.33...16.66 mA	■	■	■	■	■
166...833 μA	■	■	■	■	■
0.2...1 mA	■	■	■	■	■
2...10 mA	■	■	■	■	■
100...500 μA	■	■	■	■	■

Legend
■ ON
□ OFF
□ no influence

Type	Rated supply voltage	Order code	Pack. unit pieces	Price 1 piece
CC-U/RTD	24-48 V DC	1SVR 040 002 R0500	1	
	110-240 V AC	1SVR 040 003 R0600	1	

- Accessories 5/20
- Technical data 5/21
- Dimensional drawings 5/27

Temperature signal converter for RTD sensors CC-U/RTDR with relay output

Ordering details

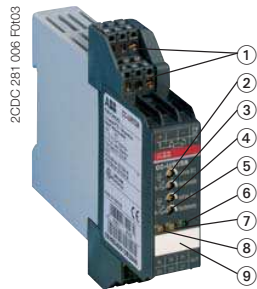

CC-U/RTDR

- ① Plug-in connecting terminals
- ② Threshold value for R1
- ③ Hysteresis for R1
- ④ Threshold value for R2
- ⑤ Hysteresis for R2
- ⑥ U: green LED - supply voltage
- ⑦ R2: yellow LED - Relay 2 energized
- ⑧ R1: yellow LED - Relay 1 energized
- ⑨ Marker label

CC-U/RTDR universal signal converter for temperature and resistance signals, with 2 threshold relay outputs and 3-way electrical isolation

- Temperature signal converter for PT100 signals (5 ranges up to 800 °C) and variable resistances from 0-380 Ω
- 2 threshold relay outputs with one c/o contact each (threshold and respective hysteresis can be adjusted independently from each other)
- Open-circuit or closed-circuit principle configurable by means of a DIP switch
- 2 yellow LEDs for clear status indication of the output relays
- Plug-in connecting terminals for inputs, outputs and supply
- 2- or 3-wire connection

Wiring instruction

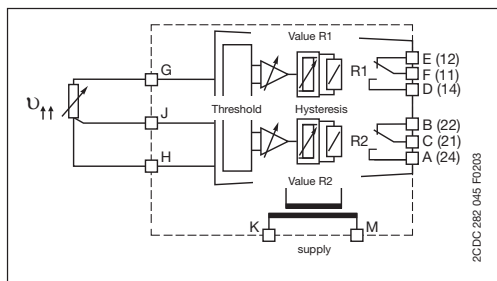

Function diagrams

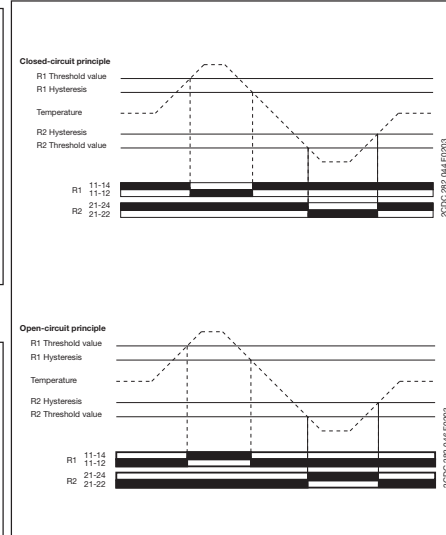

DIP switch settings

Input PT100	Switch					
	1	2	3	4	5	6
0...100 °C	■					
0...200 °C		■				
0...400 °C			■			
0...600 °C				■		
0...800 °C					■	
Output						
Closed-circuit principle						■
Open-circuit principle						

Legend:
 ■ ON
 □ OFF
 □ no influence

Switching points

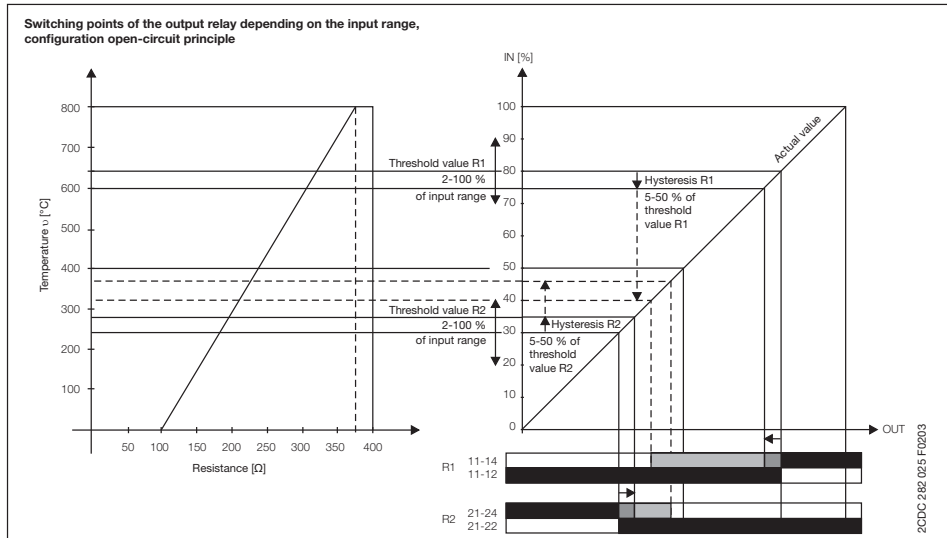

Type	Rated supply voltage	Order code	Pack. unit pieces	Price 1 piece
CC-U/RTDR	24-48 V DC	1SVR 040 012 R2600	1	
	110-240 V AC	1SVR 040 013 R2700	1	

• Accessories	5/20	• Technical data	5/21
• Technical diagrams	5/27	• Dimensional drawings	5/27

Temperature signal converter for thermocouples CC-E/TC

Ordering details



2CDC 281 007 F0103

CC-E/TC

- ① Gain adjustment
- ② Offset adjustment
- ③ U: green LED - supply voltage
- ④ DIP switch for input and output configuration (only available on universal devices)

1)  1604 Class I, Div.2 (universal device)

CC-E/TC analog signal converter for thermocouple signals of the types J and K with 3-way electrical isolation

- 2 universally configurable devices (type CC-E/TC)
- 2x6 single-function devices
- "Plug and Work", no adjustment of single-function devices required

Wiring instruction

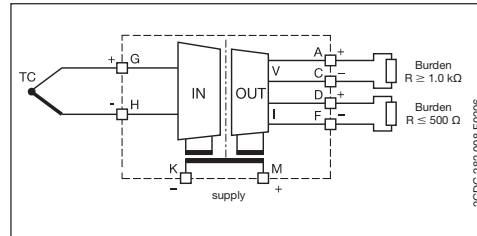

DIP switch settings (universal devices)

Input	Output	Switch					
		1	2	3	4	5	6
TC-J: 0...600 °C	0...10 V	■	■	■	■	■	■
	0...20 mA	■	■	■	■	■	■
	4...20 mA	■	■	■	■	■	■
TC-K: 0...1000 °C	0...10 V	■	■	■	■	■	■
	0...20 mA	■	■	■	■	■	■
	4...20 mA	■	■	■	■	■	■
High fail safe		■	■	■	■	■	■
Low fail safe		■	■	■	■	■	■

2CDC 282 007 F0208

Legend	
ON	■
OFF	□
no influence	■

2CDC 282 003 F0204

Type	Input signal	Output signal	Order code	Pack. unit piece	Price 1 piece
------	--------------	---------------	------------	------------------	---------------

Supply voltage: 24 V DC universal

CC-E/TC	thermocouple types J and K	0-10 V, 0-20 mA, 4-20 mA	1SVR 011 702 R2600¹⁾	1	
single-function					
CC-E TC/V	type J 0...600 °C	0-10 V	1SVR 011 750 R0100	1	
CC-E TC/I		0-20 mA	1SVR 011 751 R2600	1	
CC-E TC/I		4-20 mA	1SVR 011 752 R2700	1	
CC-E TC/V	type K 0...1000 °C	0-10 V	1SVR 011 753 R2000	1	
CC-E TC/I		0-20 mA	1SVR 011 754 R2100	1	
CC-E TC/I		4-20 mA	1SVR 011 755 R2200	1	

Supply voltage: 110-240 V AC universal

CC-E/TC	thermocouple types J and K	0-10 V, 0-20 mA, 4-20 mA	1SVR 011 707 R2300	1	
single-function					
CC-E TC/V	type J 0...600 °C	0-10 V	1SVR 011 760 R0300	1	
CC-E TC/I		0-20 mA	1SVR 011 761 R2000	1	
CC-E TC/I		4-20 mA	1SVR 011 762 R2100	1	
CC-E TC/V	type K 0...1000 °C	0-10 V	1SVR 011 763 R2200	1	
CC-E TC/I		0-20 mA	1SVR 011 764 R2300	1	
CC-E TC/I		4-20 mA	1SVR 011 765 R2400	1	

• Technical data 5/21 • Dimensional drawings 5/27

Temperature signal converter for thermocouples CC-U/TC

Ordering details

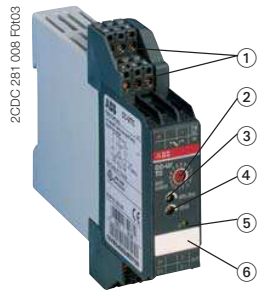

CC-U/TC

- ① Plug-in connecting terminals
- ② Gain: Coarse adjustment
- ③ Gain: Fine adjustment
- ④ Offset adjustment
- ⑤ U: green LED - supply voltage
- ⑥ Marker label

CC-U/TC universal signal converter for thermocouples with 3-way electrical isolation

- Temperature signal converter for thermocouples of the types K, J, T, S, E, N, R, B
- Continuously adjustable voltage signal input 0-10 mV and 0-50 mV
- Differential temperature meas. possible ¹⁾
- Configurable output signal response on input signal interruption (low fail safe / high fail safe)
- Adjustment and operating elements on the front-side
- Short-circuit proof signal outputs
- Plug-in connecting terminals for inputs, outputs and supply

Wiring instruction

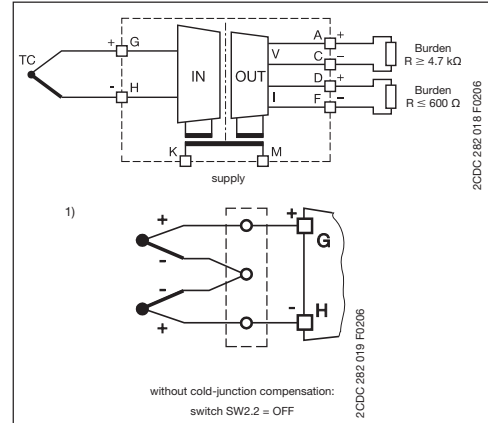

DIP switch settings

Output	Switch 3					
	1	2	3	4	5	6
0...5 V						
0...10 V						
1...5 V						
2...10 V						
-10...+10 V						
-5...+5 V						
-10...0 V						
-5...0 V						
0...6.66 V						
-10...+3.33 V						
-5...+1.66 V						
0...8 V						
0...4 V						
-10...-2 V						
-5...-1 V						
1.25...8.25 V						
-7.5...+2.5 V						
-3.75...+1.25 V						
1.66...8.33 V						
+6.66...+6.66 V						
-3.33...+3.33 V						
-8...0 V						
-4...0 V						
0...1 mA						
0...20 mA						
4...20 mA						
0...10 mA						
0...0.5 mA						
0...13.33 mA						
0...666 μA						
0...16 mA						
0...800 μA						
0...8 mA						
0...400 μA						
2.5...12.5 mA						
125...625 μA						
3.33...16.66 mA						
166...833 μA						
0.2...1 mA						
2...10 mA						
100...500 μA						

Input Type	Range	Switch 1						Switch 2						
		1	2	3	4	5	6	1	2	3	4	5	6	
K	0-100...900 °C													
K	0-250...1350 °C													
J	0-100...750 °C													
T	0-100...400 °C													
T	-150...-400 °C													
S	0-250...1550 °C													
E	0-100...700 °C													
E	0-200...1000 °C													
N	0-100...650 °C													
N	0-200...1300 °C													
R	0-250...1350 °C													
R	0-450...1700 °C													
B	0-700...1750 °C													
mV	0-2...10 mV													
mV	0-10...50 mV													
	Low fail safe *)													
	High fail safe *)													

*) Detection of input signal interruptions:
If the input signal circuit is interrupted, the output signal changes to the adjusted minimum value (low fail safe) or maximum value (high fail safe).

Characteristic curves

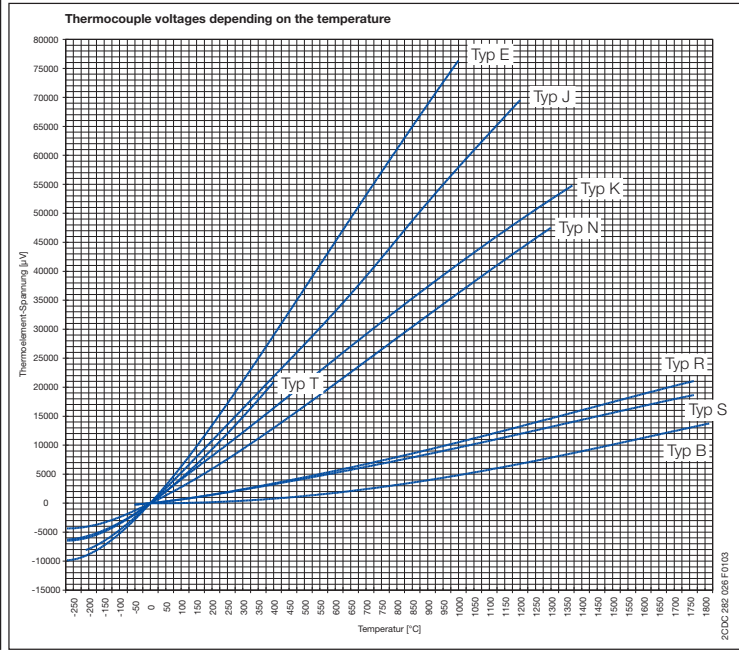

Type	Rated supply voltage	Order code	Pack. unit pieces	Price 1 piece
CC-U/TC	24-48 V DC	1SVR 040 004 R0700	1	
	110-240 V AC	1SVR 040 005 R0000	1	

- Accessories 5/20
- Technical data 5/21
- Dimensional drawings 5/27



Temperature signal converter for thermocouples CC-U/TCR with relay output

Ordering details

2CDC 281 009 F0103

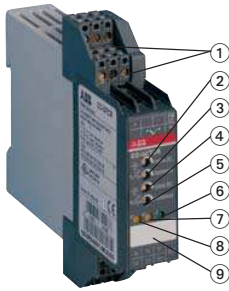

CC-U/TCR

- ① Plug-in connecting terminals
- ② Threshold value for R1
- ③ Hysteresis for R1
- ④ Threshold value for R2
- ⑤ Hysteresis for R2
- ⑥ U: green LED - supply voltage
- ⑦ R2: yellow LED - Relay 2 energized
- ⑧ R1: yellow LED - Relay 1 energized
- ⑨ Marker label

CC-U/TCR universal signal converter for thermocouples, with 2 threshold relay outputs and 3-way electrical isolation

- Temperature signal converter for thermocouples of the types K, J, T, S
- 2 threshold relay outputs with one change-over contact each (threshold and respective hysteresis can be adjusted independently from each other)
- Open-circuit or closed-circuit principle configurable by means of a DIP switch
- 2 yellow LEDs for clear status indication of the output relays
- Plug-in connecting terminals for inputs, outputs and supply

Wiring instruction

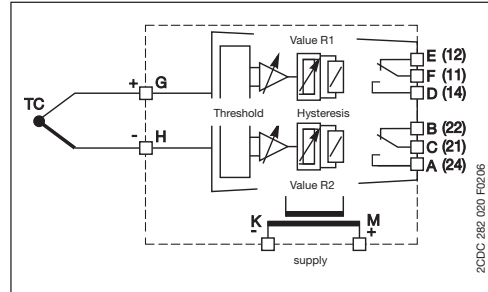

Function diagrams

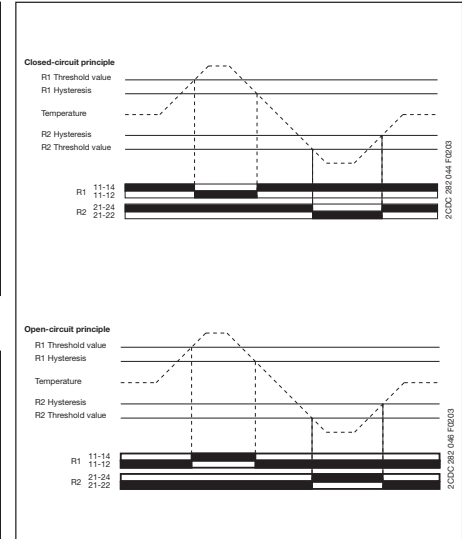

DIP switch settings

Type	Input Range	Switch					
		1	2	3	4	5	6
J	0...240 °C						
J	0...480 °C						
J	0...1200 °C						
K	0...250 °C						
K	0...500 °C						
K	0...1350 °C						
T	-150...+120 °C						
T	0...220 °C						
T	0...400 °C						
S	0...210 °C						
S	0...380 °C						
S	0...860 °C						
S	0...1550 °C						
Output							
Closed-circuit principle							
Open-circuit principle							

Legend:
 ■ ON
 □ OFF
 □ no influence

Switching points

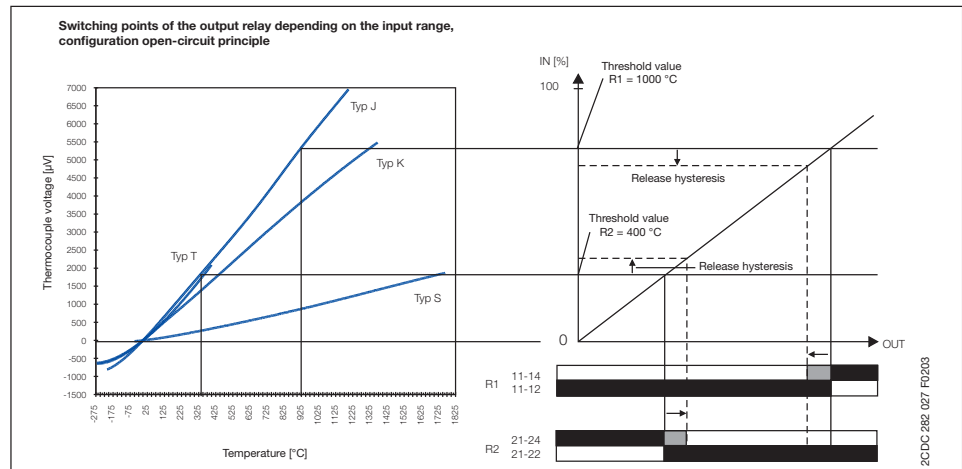

Type	Rated supply voltage	Order code	Pack. unit pieces	Price 1 piece
CC-U/TCR	24-48 V DC 110-240 V AC	1SVR 040 014 R2000 1SVR 040 015 R2100	1 1	

- Accessories 5/20
- Technical data 5/21
- Technical diagrams 5/27
- Dimensional drawings 5/27



Measuring converter for sinusoidal and DC currents CC-E/I

Ordering details

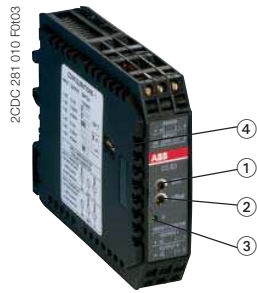

CC-E/I

- ① Gain adjustment
- ② Offset adjustment
- ③ U: green LED - supply voltage
- ④ DIP switch for input and output configuration (only available on universal devices)

CC-E/I measuring converter for current signals 0-5 A, 0-20 A, AC/DC with 3-way electrical isolation

- 2 universally configurable devices (type CC-E/I)
- 2x6 single-function devices
- "Plug and Work", no adjustment of single-function devices required

Wiring instruction

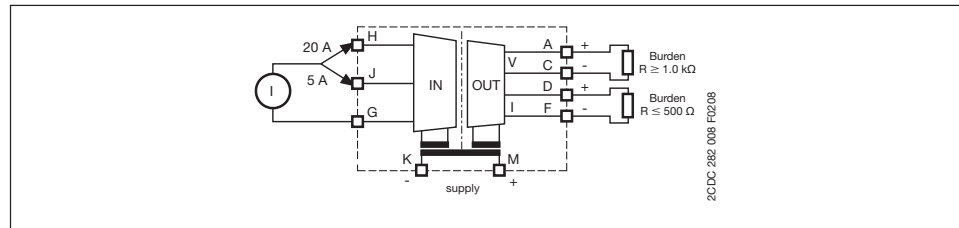

Input range selection

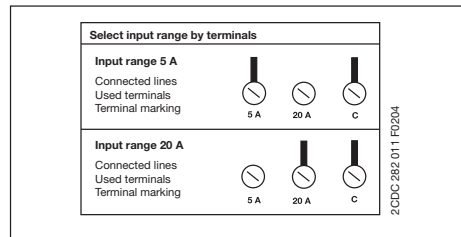

DIP switch settings (universal devices)

Input	Output	Switch					
		1	2	3	4	5	6
I - DC	0...10 V						
I - AC							
I - DC	0...20 mA						
I - AC							
I - DC	4...20 mA						
I - AC							

Legend: ON (black square), OFF (white square)

Type	Input signal	Output signal	Order code	Pack. unit pieces	Price 1 piece
------	--------------	---------------	------------	-------------------	---------------

Supply voltage: 24 V DC universal

CC-E/I	0-5 A, 0-20 A, AC/DC	0-10 V, 0-20 mA, 4-20 mA	1SVR 011 703 R2700 ¹⁾	1	
--------	----------------------	--------------------------	----------------------------------	---	--

single-function

CC-E I _{AC} /V	0-5 A, 0-20 A, AC	0-10 V	1SVR 011 770 R0500	1	
CC-E I _{AC} /I		0-20 mA	1SVR 011 771 R2200	1	
CC-E I _{AC} /I		4-20 mA	1SVR 011 772 R2300	1	
CC-E I _{DC} /V	0-5 A, 0-20 A, DC	0-10 V	1SVR 011 773 R2400	1	
CC-E I _{DC} /I		0-20 mA	1SVR 011 774 R2500	1	
CC-E I _{DC} /I		4-20 mA	1SVR 011 775 R2600	1	

Supply voltage: 110-240 V AC universal

CC-E/I	0-5 A, 0-20 A, AC/DC	0-10 V, 0-20 mA, 4-20 mA	1SVR 011 708 R0400	1	
--------	----------------------	--------------------------	--------------------	---	--

single-function

CC-E I _{AC} /V	0-5 A, 0-20 A, AC	0-10 V	1SVR 011 780 R1100	1	
CC-E I _{AC} /I		0-20 mA	1SVR 011 781 R0600	1	
CC-E I _{AC} /I		4-20 mA	1SVR 011 782 R0700	1	
CC-E I _{DC} /V	0-5 A, 0-20 A, DC	0-10 V	1SVR 011 783 R0000	1	
CC-E I _{DC} /I		0-20 mA	1SVR 011 784 R0100	1	
CC-E I _{DC} /I		4-20 mA	1SVR 011 785 R1100	1	

¹⁾ UL 1604 Class I, Div.2 (universal device)

Measuring converter for sinusoidal currents

CC-E I_{AC}/ILPO

Ordering details

2CDC 281 016 R0104



CC-E I_{AC}/ILPO

- ① Gain adjustment
- ② Offset adjustment
- ③ Selection of measuring range

CC-E I_{AC}/ILPO measuring converter without auxiliary power for sinusoidal currents
0-1 A, 0-5 A, output 4-20 mA

- Measuring converter for sinusoidal currents (0-1 A, 0-5 A)
- Measuring range selection by front-face sliding switch
- 4-20 mA output current in proportion to input current
- no additional power supply required

Wiring instruction

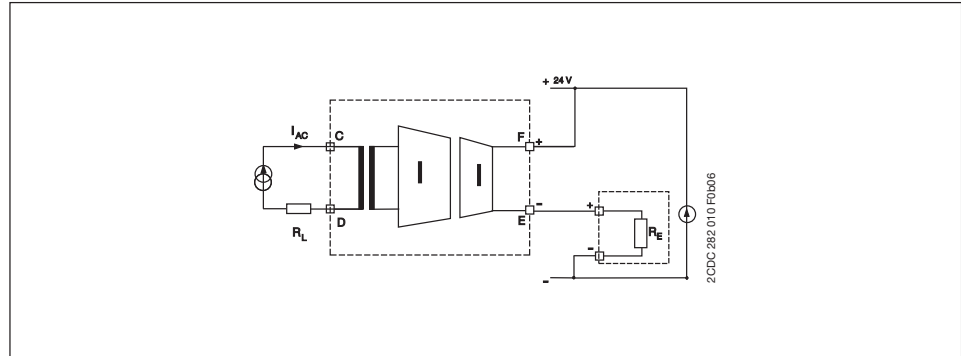

Type	Input signal	Order code	Pack. unit pieces	Price 1 piece
CC-E I _{AC} /ILPO	0-1 A, 0-5 A, AC	1SVR 010 203 R0500	1	

Measuring converter for current RMS values CC-U/I

Ordering details

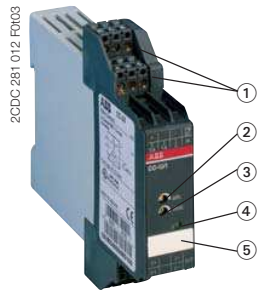

CC-U/I

- ① Plug-in connecting terminals
- ② Gain adjustment
- ③ Offset adjustment
- ④ U: green LED - supply voltage
- ⑤ Marker label

CC-U/I universal measuring converter for RMS values of 0-1 A and 0-5 A, with 3-way electrical isolation

- RMS converter for current signals up to 1 A and up to 5 A of any wave form (DC, DC with superimposed AC components, pure sinusoidal, triangular, phase-angle controlled, etc. in a measuring range of 0-600 Hz)
- Adjustment and operating elements on the front
- Short-circuit proof signal outputs
- Plug-in connecting terminals for inputs, outputs and supply

Wiring instruction

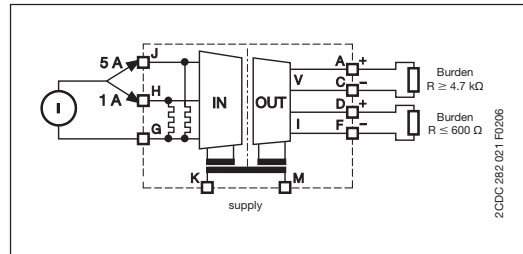

DIP switch settings

Output	Switch					
	1	2	3	4	5	6
0...5 V						
0...10 V						
1...5 V						
2...10 V						
-10...+10 V						
-5...+5 V						
-10...0 V						
-5...0 V						
0...6.66 V						
-10...+3.33 V						
-5...+1.66 V						
0...8 V						
0...4 V						
-10...-2 V						
-5...-1 V						
1.25...6.25 V						
-7.5...+2.5 V						
-3.75...+1.25 V						
1.66...8.33 V						
-6.66...+6.66 V						
-3.33...+3.33 V						
-8...0 V						
-4...0 V						
0...1 mA						
0...20 mA						
4...20 mA						
0...10 mA						
0...0.5 mA						
0...13.33 mA						
0...666 μA						
0...16 mA						
0...800 μA						
0...8 mA						
0...400 μA						
2.5...12.5 mA						
125...625 μA						
3.33...16.66 mA						
166...833 μA						
0.2...1 mA						
2...10 mA						
100...500 μA						

Input range selection

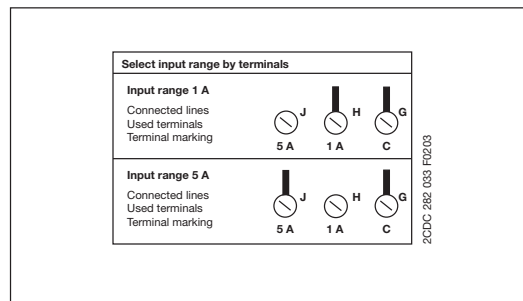

Example of application

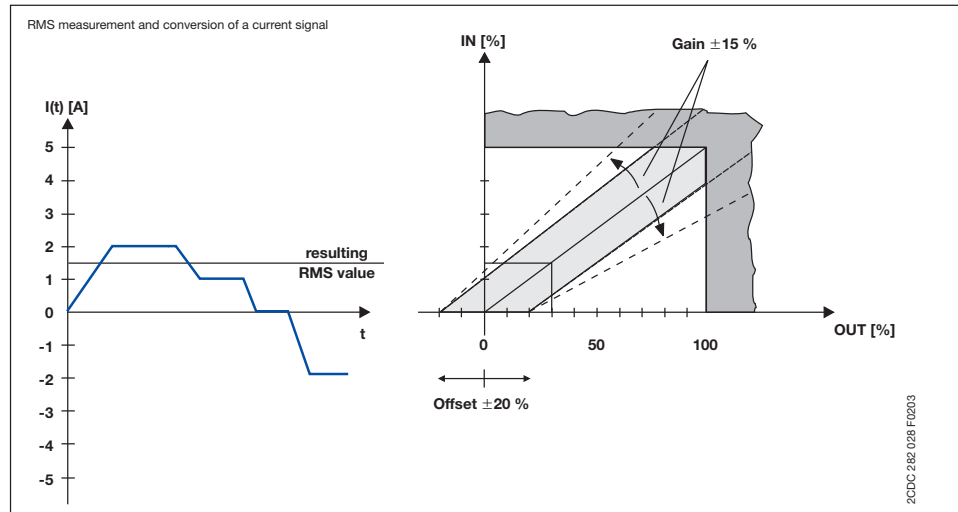

Type	Rated supply voltage	Order code	Pack. unit pieces	Price 1 piece
CC-U/I	24-48 V DC 110-240 V AC	1SVR 040 006 R0100 1SVR 040 007 R0200	1 1	

- Accessories 5/20
- Technical data 5/21
- Dimensional drawings 5/27

Measuring converter for voltage RMS values CC-U/V

Ordering details

2CDC 281 013 F0103

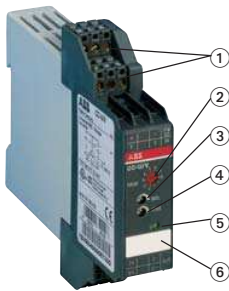

CC-U/V

- ① Plug-in connecting terminals
- ② Input voltage range selection
- ③ Gain adjustment
- ④ Offset adjustment
- ⑤ U: green LED - supply voltage
- ⑥ Marker label

CC-U/V universal measuring converter for RMS values of 0-600 V, with 3-way electrical isolation

- RMS converter for voltage signals up to 600 V of any wave form (DC, DC with superimposed AC components, pure sinusoidal, triangular, phase-angle controlled, etc. in a measuring range of 0-600 Hz)
- Adjustment and operating elements on the front
- Short-circuit proof signal outputs
- Plug-in connecting terminals for inputs, outputs and supply

Wiring instruction

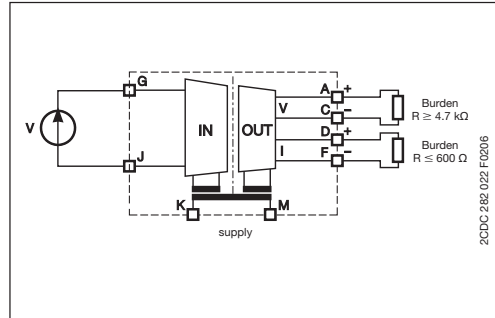

DIP switch settings

Output	Switch					
	1	2	3	4	5	6
0...5 V						
0...10 V						
1...5 V						
2...10 V						
-10...+10 V						
-5...+5 V						
-10...0 V						
-5...0 V						
0...6.66 V						
-10...+3.33 V						
-5...+1.66 V						
0...8 V						
0...4 V						
-10...-2 V						
-5...-1 V						
1.25...6.25 V						
-7.5...+2.5 V						
-3.75...+1.25 V						
1.66...8.33 V						
-6.66...+6.66 V						
-3.33...+3.33 V						
-8...0 V						
-4...0 V						
0...1 mA						
0...20 mA						
4...20 mA						
0...10 mA						
0...0.5 mA						
0...13.33 mA						
0...666 μA						
0...16 mA						
0...800 μA						
0...8 mA						
0...400 μA						
2.5...12.5 mA						
125...625 μA						
3.33...16.66 mA						
166...833 μA						
0.2...1 mA						
2...10 mA						
100...500 μA						

Input range selection

Selecting input range by front-face rotary switch	Switch position
0...100 V	1
0...150 V	2
0...250 V	3
0...300 V	4
0...400 V	5
0...450 V	6
0...550 V	7
0...600 V	8

Example of application

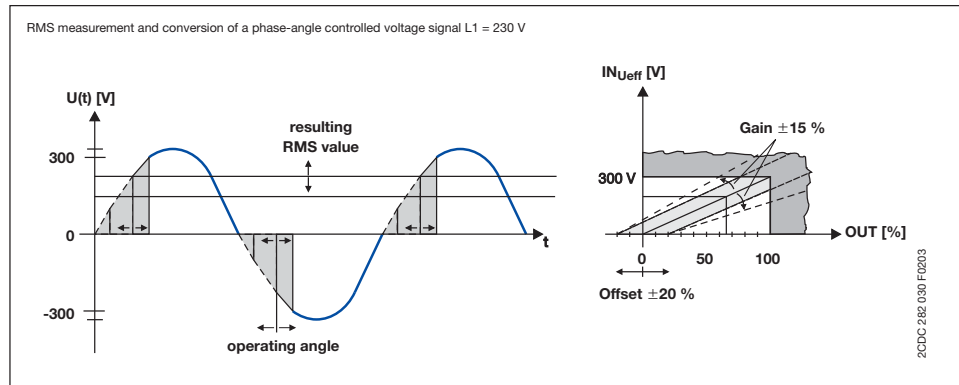

Type	Rated supply voltage	Order code	Pack. unit pieces	Price 1 piece
CC-U/V	24-48 V DC	1SVR 040 008 R1300	1	
	110-240 V AC	1SVR 040 009 R1400	1	

- Accessories 5/20
- Technical data 5/21
- Dimensional drawings 5/27

Analog signal converters

Accessories for CC-U range

Ordering details

Accessories

Adapter for screw mounting

Type	for type	Width in mm	Order code	Pack. unit pieces	Price 1 piece	Weight 1 piece g / oz
ADP.01	CC-U	22.5	1SVR 430 029 R0100	1		18.4/0.65

Marker label

Type	for type	Order code	Pack. unit pieces	Price 1 piece	Weight 1 piece g / oz
MAR.01	CC-U	1SVR 366 017 R0100	10		0.19/0.007

Sealable transparent cover

Type	for type	Width in mm	Order code	Pack. unit pieces	Price 1 piece	Weight 1 piece g / oz
COV.01	CC-U	22.5	1SVR 430 005 R0100	1		5.2/0.18

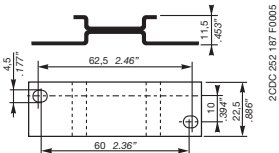

ADP.01



MAR.01

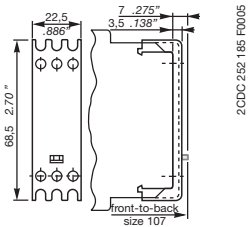

**Sealable cover
COV.01**

Analog signal converters

CC-E/STD, CC-E x/x, CC-E/RTD, CC-E/TC

Technical data

Type		CC-E/STD		CC-E/RTD ³⁾	CC-E/TC
Input circuits - Analog inputs	J-G-H	Current	Voltage	Temperature sensors	Thermocouples (IEC 584-1 and 2)
Input signal		Standard signals		PT100	TC.K, TC.J
Rated input range		0...20 mA / 4...20 mA	0...5 V / 0...10 V / -10...+10 V	-50...+500 °C	TC.K: 0...1000 °C, TC.J: 0...600 °C
Limitation of input signals		+55 mA	± 11 V		
Influence of line resistance		-		< 0.01 %/Ω	< 0.5 % / 100 Ω
Gain adjustment range		± 5 % (universal devices)			
Offset adjustment range		± 5 % (universal devices)			
Input impedance		50 Ω	1 MΩ	-	-
Suppression at 50 Hz		-		-	> 35 dB
Common-mode rejection		-		100 dB	
Output circuits - Analog outputs	D-F, A-C	Current		Voltage	
Output signal		0-20 mA, 4-20 mA		0-5 V, 0-10 V	
Output burden		≤ 500 Ω		≥ 1.0 kΩ	
Accuracy ¹⁾		± 0.5 % of full-scale			
Residual ripple		< 0.5 %			
Response time		200 μs		10 ms	
Transmission frequency		2 kHz		80 Hz	2 Hz (up to -3 dB)
Reaction to input circuit interruption		High fail safe: Output voltage > 115 % of measuring range ²⁾ Low fail safe: Output voltage < -0.6 V, output current = 0 mA			
Supply circuits	K-M	DC versions		AC versions	
Supply voltage		24 V DC		110-240 V AC - 50/60 Hz	
Supply voltage tolerance		-15...+15 %		-15...+10 %	
Power consumption		1.5 W typ.		1.5 VA typ.	
Indication of operational states					
Rated control supply voltage U _s		U: green LED			
General data					
Ambient temperature range	operation / storage	0...+60 °C / -20...+80 °C			
Temperature coefficient		± 500 ppm/°C			
Degree of protection (DIN 40050)		IP20			
Mounting position		ventilation slots on top and bottom			
Mounting		DIN rail (IEC/EN 60715), snap-on mounting			
Electrical connection					
Wire size	rigid	0.2-4 mm ² (24-12 AWG)			
	fine-strand with(out) wire end ferrule	0.2-2.5 mm ² (24-14 AWG)			
Stripping length		7 mm (0.28 inch)			
Tightening torque		0.5 Nm (4.4 lb.in)			
Electromagnetic compatibility					
Interference immunity		EN 61000-6-2			
electrostatic discharge (ESD)	IEC/EN 61000-4-2	Level 3 (±6 kV / ±8 kV)			
electromagnetic field (HF radiation resistance)	IEC/EN 61000-4-3	10 V/m			
fast transients (Burst)	IEC/EN 61000-4-4	Level 3 (±2 kV / 5 kHz)			
powerful impulses (Surge)	IEC/EN 61000-4-5	±2 kV / ±1 kV			
HF line emission	IEC/EN 61000-4-6	10 V			
Interference emission	EN 61000-6-4	Class B			
Isolation data					
Test voltage between all isolated circuits		2.5 kV AC			
Rated insulation voltage		-	-	-	-

¹⁾ includes: non-linearity, factory setting, drift of temperature, supply voltage and output load

²⁾ Only -/RTD and -/TC: Single-function devices respond with Low fail safe to input signal interruptions

³⁾ When connecting a 2-wire sensor, the terminals J and H have to be jumpered.



Analog signal converter

CC-E I/I-1, CC-E I/I-2

Technical data

5

Type	CC-E I/I	
Input circuits - Analog inputs		
Current		
Input current I_{IN}	0-20 mA, 4-20 mA	
Min. input current	< 100 μ A	
Max. input current	50 mA ¹⁾ ($V_{IN} < 18$ V)	
Input voltage U_{IN}	< 2.5 V + ($I_{IN} \times R_L$)	
Input voltage drop U_i	< 2.5 V (20 mA, $R_L = 0 \Omega$)	
Max. input voltage	18 V ¹⁾ ($I_{IN} < 50$ mA)	
Output circuits		
Output current I_{OUT}	0-20 mA, 4-20 mA	
Output load R_L	0-500 Ω	
Output voltage U_{OUT}	$I_{OUT} \times R_L$	
Residual ripple	< 20 mV _{pp} (500 Ω , 20 mA)	
Response time (0-100 %)	< 15 ms (0-500 Ω , 20 mA), < 5 ms (500 Ω , 20 mA, 25 °C)	
Accuracy	≤ 0.1 % of full-scale (20 mA)	
Load influence (0-500 Ω)	$\leq \pm 0.05$ % / 100 Ω , ≤ -0.1 % / 100 Ω (25 °C)	
General data		
Width of the enclosure	18 mm	
Weight	1 channel	approx. 0.037 kg (0.082 lb)
	2 channel	approx. 0.044 kg (0.097 lb)
Mounting position	any	
Degree of protection	enclosure / terminals	IP20 / IP20
Ambient temperature range	operation / storage	-25...+60 °C / -40...+85 °C
Temperature coefficient	< ± 50 ppm / °C	
Mounting	DIN rail (IEC/EN 60715)	
Electrical connection		
Wire size	rigid	0.2-4 mm ² (24-12 AWG)
	fine-strand with(out) wire end ferrule	0.2-2.5 mm ² (24-14 AWG)
Stripping length	7 mm (0,28 inch)	
Tightening torque	0.5 Nm (4.4 lb.in)	
Standards		
Product standard	EN 50178	
Low Voltage Directive	2006/95/EC	
EMC Directive	2004/108/EC	
Electromagnetic compatibility		
Interference immunity	EN 61000-6-2	
electrostatic discharge (ESD)	EN 61000-4-2	Level 3 (± 6 kV / ± 8 kV)
electromagnetic field (HF radiation resistance)	EN 61000-4-3	10 V/m
fast transients (Burst)	EN 61000-4-4	Level 3 (± 2 kV / 5 kHz)
powerful impulses (Surge)	EN 61000-4-5	± 2 kV / ± 1 kV
HF line emission	EN 61000-4-6	10 V
magnetisches Feld	EN 61000-4-8	30 A/m
Interference emission	EN 61000-6-4	
Radiated noise	EN 55011	Class B
Operational reliability (EN 68-2-6)	4 g	
Mechanical resistance (EN 68-2-6)	10 g	
Environmental testing (IEC 68-2-30 Db)	24 h cycle, 55 °C, 93 % rel., 96 h	
Isolation data		
Insulation voltage input / output	500 V _{eff} / 50 Hz	
Insulation voltage between channels	5 kV _{eff} / 50 Hz (device with 2 channels)	
Pollution category	2	
Overvoltage category	II	

¹⁾ The input parameters have to be limited to the indicated maximum values.

• Approvals 5/3

Analog signal converters

CC-U/STD, CC-U/RTD, CC-U/TC

Technical data

Type	CC-U/STD			CC-U/RTD ³⁾	CC-U/TC	
Input circuits - Analog inputs	J-G-H	Current	Voltage	Potentiometer	Temperature sensors	Thermocouples (IEC 584-1 and 2)
Input signal		0-20 mA 4-20 mA 10-50 mA 0-1 mA	0-100 mV 0-1 V 0-5 V 1-5 V 0-10 V 2-10 V ± 10 V	470 Ω - 1 MΩ ²⁾	PT10, PT100, PT1000 (IEL 751 and JICC 1604)	TC.K TC.J TC.T TC.S TC.E TC.N TC.R TC.B
Limitation of input signals		± 55 mA	± 11 V		-	-
Rated input range		-	-	-	Max. temperature adjustable: 6-60 °C for PT1000 50-500 °C for PT100 500-850 °C for PT10	refer to temperature specs. of individual thermocouples
Influence of line resistance		-	-	-	0.015 °C/Ω	< 0.01 % / 100 Ω
Gain adjustment range (universal devices)		0.9- 110 mA	45 mV - 22 V	-	see DIP switch settings	
Offset adjustment range (universal devices)		-137.5...+62.5 %			± 5 %	± 10 %
Input impedance		for different ranges			-	-
without detection of input signal interruption		51 Ω	6 MΩ	3 GΩ	-	-
with detection of input signal interruption		51 Ω	3.5 MΩ	9.5 GΩ	-	-
Suppression at 50 Hz		-	-	-	-	> 40 dB
Common-mode rejection		-	-	-	120 dB	105 dB
Output circuits - Analog outputs	D-F, A-C	Current		Voltage		
Output signal		0-20 mA, 4-20 mA		0-5 V, 1-5 V, 0-10 V, 2-10 V, ± 10 V		
Output burden		≤ 600 Ω		≥ 4.7 kΩ		
Accuracy ¹⁾		±0.1 % of full-scale		±0.2 % of full-scale		±0.1 % of full-scale
Residual ripple		-		< 0.15 %		-
Response time		200 μs		10 ms		200 ms
Transmission frequency		1 kHz		80 Hz		2 Hz (to -3 dB)
Supply circuits	K-M					
Rated supply voltage		24-48 V DC		110-240 V AC		
Supply voltage range		24-48 V DC / 24 V AC		110-240 V AC / 100-300 V DC		
Supply voltage tolerance		DC: -15...+15 %		AC: -15...+10 %		
Rated frequency		0 Hz or 50/60 Hz				
Power consumption		2 W at 24 V DC		4.5 VA at 230 V AC		
Indication of operational states						
Supply voltage		U: green LED				
General data						
Ambient temperature range	operation / storage	-20...+60 °C / -40...+80 °C				
Temperature coefficient		±150 ppm/°C		±250 ppm/°C		±200 ppm/°C at min. offset ±400 ppm/°C at max. offset
Mounting position		any				
Mounting		DIN rail (IEC/EN 60715), snap-on mounting / screw mounting with adapter				
Electrical connection						
Wire size	rigid	plug-connector with screw terminals 0.2-2.5 mm ² (24-12 AWG)				
	fine-strand with(out) wire end ferrule	plug-connector with screw terminals 0.2-2.5 mm ² (24-12 AWG)				
Stripping length		7 mm (0.28 inch)				
Tightening torque		0.4 Nm (3.5 lb.in)				
Electromagnetic compatibility						
Interference immunity		EN 61000-6-2				
electrostatic discharge (ESD)	IEC/EN 61000-4-2	Level 3 (±6 kV / ±8 kV)				
electromagnetic field (HF radiation resistance)	IEC/EN 61000-4-3	10 V/m				
fast transients (Burst)	IEC/EN 61000-4-4	Level 3 (±2 kV / 5 kHz)				
powerful impulses (Surge)	IEC/EN 61000-4-5	±2 kV / ±1 kV				
HF line emission	IEC/EN 61000-4-6	10 V				
Interference emission	EN 61000-6-4	Class B				
Isolation data						
Isolation test (between all isolated circuits)		1.5 kV				
Test voltage (between all isolated circuits)		1.5 kV / 50 Hz				

¹⁾ includes: non-linearity, factory setting, drift of temperature, supply voltage and output load

²⁾ Detection of an input signal break (fail safe) and resistance > 10 kΩ results in a linearity of ±0.2 %.

³⁾ When connecting a 2-wire sensor, the terminals J and H have to be jumpered.

• Approvals 5/3

Analog signal converters with relay output

CC-U/STDR, CC-U/RTDR, CC-U/TCR

Technical data

Type		CC-U/STDR		CC-U/RTDR ¹⁾	CC-U/TCR
Input circuits - Analog inputs		J-H			
		Current	Voltage	Temperature sensors	Thermocouples (IEC 584-1 and 2)
Measuring signal / input range		0-20 mA 4-20 mA	0-1 V / 1-5 V 0-10 / ±10 V	PT100	TC.K, TC.J TC.T, TC.S
Input resistance		approx. 50 Ω	approx. 1,5 MΩ		
Adjustable threshold		2-100 % of selected input range			
Adjustable hysteresis		5-50 % of threshold			
Repeat accuracy (constant parameters)		±0.5 % of full-scale			
Output circuits - Relay outputs		E-D-F, B-C-A		Relay, 2 c/o contacts	
Rated switching voltage		250 V AC			
Rated switching current	AC12 (resistive) 230 V	4 A			
	AC15 (inductive) 230 V	3 A			
	DC12 (resistive) 24 V	4 A			
	DC13 (inductive) 24 V	2 A			
AC rating (UL 508)	Utilization category (Control Circuit Rating Code)	B 300			
	max. rated operational voltage	300 V AC			
	max. continuous thermal current at B 300	5 A			
	max. making/breaking apparent power at B 300	3600/360 VA			
Minimum switching voltage		12 V			
Minimum switching current / power		10 mA / 0.6 VA (W)			
Response time		10 ms			
Mechanical lifetime		30 x 10 ⁶ switching cycles			
Electrical lifetime		0.1 Mio. switching cycles			
		at AC12, 230 V, 4 A			
Supply circuits		K-M			
Rated supply voltage		24-48 V DC	110-240 V AC		
Supply voltage range		24-48 V DC / 24 V AC	110-240 V AC / 100-300 V DC		
Supply voltage tolerance		DC: -15...+15 %	AC: -15...+10 %		
Rated frequency		0 Hz or 50/60 Hz			
Power consumption		2 W at 24 V DC	4.5 VA at 230 V AC		
Indication of operational states					
Supply voltage		U: green LED			
1st / 2nd output relay energized		R1: yellow LED / R2: yellow LED			
General data					
Ambient temperature range		operation / storage		-20...+60 °C / -40...+80 °C	
Temperature coefficient		±300 ppm/°C			
Mounting position		any			
Mounting		DIN rail (IEC/EN 60715), snap-on mounting / screw mounting with adapter			
Electrical connection					
Wire size		rigid	plug-connector with screw terminals 0.2-2.5 mm ² (24-12 AWG)		
		fine-strand with(out) wire end ferrule	plug-connector with screw terminals 0.2-2.5 mm ² (24-12 AWG)		
Stripping length		7 mm (0.28 inch)			
Tightening torque		0.4 Nm (3.5 ib.in)			
Electromagnetic compatibility					
Interference immunity		EN 61000-6-2			
electrostatic discharge (ESD)		IEC/EN 61000-4-2	Level 3 (±6 kV / ±8 kV)		
electromagnetic field (HF radiation resistance)		IEC/EN 61000-4-3	10 V/m		
fast transients (Burst)		IEC/EN 61000-4-4	Level 3 (±2 kV / 5 kHz)		
powerful impulses (Surge)		IEC/EN 61000-4-5	±2 kV / ±1 kV		
HF line emission		IEC/EN 61000-4-6	10 V		
Interference emission		EN 61000-6-4	Class B		
Isolation data					
Insulation voltage (between all isolated circuits)		2.5 kV			
Test voltage (between all isolated circuits)		2.5 kV			

¹⁾ When connecting a 2-wire sensor, the terminals J and H have to be jumpered.

• Approvals 5/3

Analog signal converters

CC-U/I, CC-U/V

Technical data

Type		CC-U/I	CC-U/V
Input circuits - Analog inputs	J-G-H	any current signals, RMS measurement	any voltage signals, RMS measurement
Rated input range		0-1 A 0-5 A	0-100 V, 0-200 V 0-300 V, 0-400 V 0-500 V, 0-600 V
Measuring frequency		0-600 Hz	
Overload capacity of inputs	input range 1 input range 2	10 x I _{Nom} (10 A) for max. 2 s 10 x I _{Nom} (50 A) for max. 2 s	- -
Gain adjustment range		±15 %	
Offset adjustment range		±20 %	
Input impedance / resistance		1A: 60 mΩ, 5 A: 12 mΩ	> 800 kΩ
Output circuits - Analog outputs	D-F, A-C	Current	Voltage
Output signal		0-20 mA, 4-20 mA	0-5 V, 1-5 V, 0-10 V, 2-10 V, ± 10 V
Output load		≤ 600 Ω	≥ 4.7 kΩ
Accuracy ¹⁾		±0.5 % of full-scale	
Temperature coefficient		±250 ppm/°C max.	±300 ppm/°C max.
Residual ripple		< 0.15 %	
Response time		150 ms	
Supply circuits	K-M		
Rated supply voltage		24-48 V DC	110-240 V AC
Supply voltage range		24-48 V DC, 24 V AC	110-240 V AC, 100-300 V DC
Supply voltage tolerance		DC: -15...+15 %	AC: -15...+10 %
Rated frequency		0 Hz or 50/60 Hz	
Power consumption		2 W at 24 V DC	4.5 VA at 230 V AC
Indication of operational states			
Supply voltage		U: green LED	
General data			
Ambient temperature range	operation / storage	-20...+60 °C / -40...+80 °C	
Mounting position		any	
Mounting		DIN rail (IEC/EN 60715), snap-on mounting / screw mounting with adapter	
Electrical connection			
Wire size	rigid fine-strand with(out) wire end ferrule	plug-connector with screw terminals 0.2-2.5 mm ² (24-12 AWG)	
Stripping length		7 mm (0.28 inch)	
Tightening torque		0.4 Nm (3.5 lb.in)	
Standards			
Product standard		-	
Low Voltage directive		2006/95/EG	
EMC directive		2004/108/EG	
RoHS directive		2002/95/EG	
Electromagnetic compatibility			
Interference immunity		EN 61000-6-2	
electrostatic discharge (ESD)	IEC/EN 61000-4-2	Level 3 (±6 kV / ±8 kV)	
electromagnetic field (HF radiation resistance)	IEC/EN 61000-4-3	10 V/m	
fast transients (Burst)	IEC/EN 61000-4-4	Level 3 (±2 kV / 5 kHz)	
powerful impulses (Surge)	IEC/EN 61000-4-5	±2 kV / ±1 kV	
HF line emission	IEC/EN 61000-4-6	10 V	
Interference emission	EN 61000-6-4	Class B	
Isolation data			
Insulation voltage (between all isolated circuits)		1.5 kV	
Test voltage (between all isolated circuits)		1.5 kV / 50 Hz	

¹⁾ includes: non-linearity, factory setting, drift of temperature, supply voltage and output load

• Approvals 5/3

Analog signal converters CC-E, CC-U

Technical diagr., Connection diagr., Dimensional drawings

Technical diagrams

Load limit curves CC-U/xxR

Resistive AC load

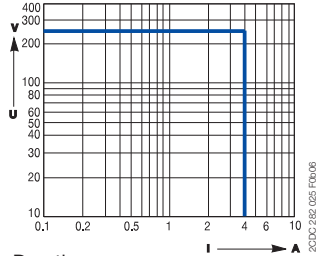

Derating curve

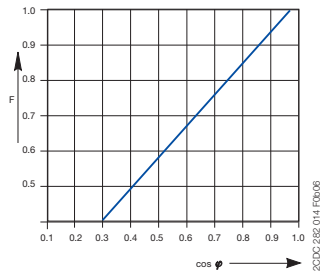

Resistive DC load

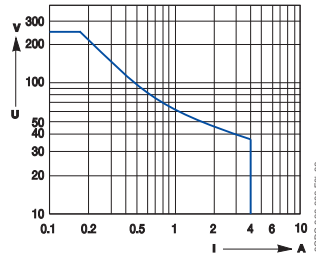

Connection diagram CC-U/x

Width 22.5 mm (0.89 in)



Dimensional drawings

Dimensions in mm

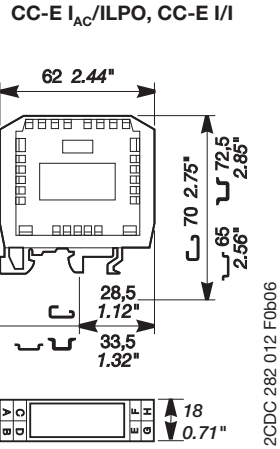
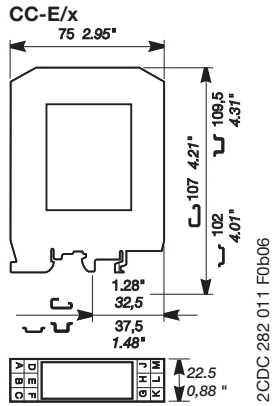

CC-U/x , CC-U/xR

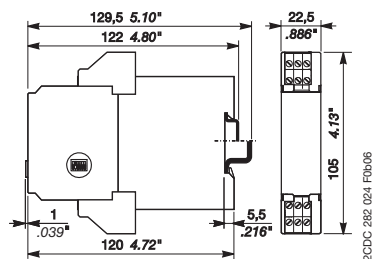

Notes

5

