

Safety-door Switch

D4NS

CSM_D4NS_DS_E_5_2

Multi-contact, Labor-saving, Environment-friendly, Next-generation Safety-door Switch



- Lineup includes three contact models with 2NC/1NO and 3NC contact forms and MBB models in addition to the previous contact forms 1NC/1NO, and 2NC.
- M12-connector models are available, saving on labor and simplifying replacement.
- Standardized gold-clad contacts provide high contact reliability.
Applicable to both standard loads and microloads.
- Variety of metallic heads available.

 Be sure to read the "Safety Precautions" on page 10 and the "Precautions for All Safety Door Switches".

Model Number Structure

Model Number Legend

Switch (Standard type)

D4NS-□□□
1 2 3

- 1. Conduit/Connector size**
 - 1:Pg13.5 (1-conduit)
 - 2:G1/2 (1-conduit)
 - 4:M20 (1-conduit)
 - 6:G1/2 (2-conduit)
 - 8:M20 (2-conduit)
 - 9:M12 connector (1-conduit)
- 2. Built-in Switch**
 - A:1NC/1NO (slow-action)
 - B:2NC (slow-action)
 - C:2NC/1NO (slow-action)
 - D:3NC (slow-action)
 - E:1NC/1NO (MBB contact)
 - F:2NC/1NO (MBB contact)
- 3. Head Mounting Direction**
 - F:Four mounting directions possible (Front-side mounting at shipping)/plastic
 - D:Four mounting directions possible (Front-side mounting at shipping)/metal

Note: An order for the head part or the switch part alone cannot be accepted. (The Operation Key is sold separately.)

Switch (High pull-force type)

D4NS-□□F-SJ
1 2

- 1. Conduit size**
 - 2:G1/2 (1-conduit)
 - 4:M20 (1-conduit)
- 2. Built-in Switch**
 - A:1NC/1NO (slow-action)
 - B:2NC (slow-action)
 - C:2NC/1NO (slow-action)
 - D:3NC (slow-action)

Operation Key

D4DS-K□
1

- 1. Operation Key Type**
 - 1:Horizontal mounting
 - 2:Vertical mounting
 - 3:Adjustable mounting (Horizontal)
 - 5:Adjustable mounting (Horizontal/Vertical)

Ordering Information

Switches (Operation Keys are sold separately.)



■ : Models with certified direct opening contacts.

Consult with your OMRON representative when ordering any models that are not listed in this table.

Type	Contact configuration	Conduit opening/Connector	Model			
1-Conduit	Slow-action	1NC/1NO	Pg13.5	D4NS-1AF *		
			G1/2	D4NS-2AF *		
			M20	D4NS-4AF		
		2NC	Pg13.5	D4NS-1BF *		
			G1/2	D4NS-2BF *		
			M20	D4NS-4BF		
		2NC/1NO	Pg13.5	D4NS-1CF *		
			G1/2	D4NS-2CF *		
			M20	D4NS-4CF		
	3NC	Pg13.5	D4NS-1DF *			
		G1/2	D4NS-2DF *			
		M20	D4NS-4DF			
	Slow-action MBB contact	1NC/1NO	Pg13.5	D4NS-1EF		
			G1/2	D4NS-2EF		
			M20	D4NS-4EF		
		2NC/1NO	Pg13.5	D4NS-1FF		
			G1/2	D4NS-2FF		
			M20	D4NS-4FF		
2-Conduit	Slow-action	1NC/1NO	G1/2	D4NS-6AF		
			M20	D4NS-8AF		
		2NC	G1/2	D4NS-6BF		
			M20	D4NS-8BF		
		2NC/1NO	G1/2	D4NS-6CF		
			M20	D4NS-8CF		
	3NC	G1/2	D4NS-6DF			
		M20	D4NS-8DF			
	Slow-action MBB contact	1NC/1NO	G1/2	D4NS-6EF		
			M20	D4NS-8EF		
		2NC/1NO	G1/2	D4NS-6FF		
			M20	D4NS-8FF		
1-Conduit, with connector		Slow-action	M12 connector	D4NS-9AF		
				D4NS-9BF		
	Slow-action MBB contact	1NC/1NO		D4NS-9EF		
	1-Conduit (High pull-force type)	Slow-action		1NC/1NO	G1/2	D4NS-2AF-SJ *
					M20	D4NS-4AF-SJ *
2NC			G1/2	D4NS-2BF-SJ *		
			M20	D4NS-4BF-SJ *		
2NC/1NO			G1/2	D4NS-2CF-SJ *		
			M20	D4NS-4CF-SJ *		
3NC			G1/2	D4NS-2DF-SJ *		
			M20	D4NS-4DF-SJ *		

* Models with Korean S-mark certification.

Operation Keys

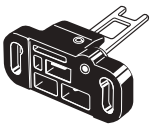
Type	Model
Horizontal mounting 	D4DS-K1
Vertical mounting 	D4DS-K2
Adjustable mounting (Horizontal) 	D4DS-K3
Adjustable mounting (Horizontal/Vertical) 	D4DS-K5

Specifications

Standards and EC Directives

Conforms to the following EC Directives:

- Machinery Directive
- Low Voltage Directive
- EN50047
- EN60204-1
- EN1088
- GS-ET-15

Certified Standards

Certification body	Standard	File No.
TÜV SÜD	EN60947-5-1 (certified direct opening)	Consult your OMRON representative for details.
UL *1	UL508, CSA C22.2 No.14	E76675
CQC (CCC)	GB14048.5	2003010305077330
KOSHA *2	EN60947-5-1	2005-197

*1. Certification for CSA C22.2 No. 14 is authorized by the UL mark.

*2. Only certain models have been certified.

Certified Standard Ratings

TÜV (EN60947-5-1), CCC (GB14048.5)

Item	Utilization category	AC-15	DC-13
Rated operating current (I _o)		3 A	0.27 A
Rated operating voltage (U _e)		240 V	250 V

Note: Use a 10 A fuse type gI or gG that conforms to IEC60269 as a short-circuit protection device. This fuse is not built into the Switch.

UL/CSA (UL508, CSA C22.2 No. 14)

A300

Rated voltage	Carry current	Current (A)		Volt-amperes (VA)	
		Make	Break	Make	Break
120 VAC	10 A	60	6	7,200	720
240 VAC		30	3		

Q300

Rated voltage	Carry current	Current (A)		Volt-amperes (VA)	
		Make	Break	Make	Break
125 VDC	2.5 A	0.55	0.55	69	69
250 VDC		0.27	0.27		

Characteristics

Degree of protection *1		IP67 (EN60947-5-1)
Durability *2	Mechanical	<Standard type> 1,000,000 operations min. <High pull-force type> 100,000 operations min.
	Electrical	<Standard type> 500,000 operations min. (3 A resistive load at 250 VAC) *3 300,000 operations min. (10 A resistive load at 250 VAC) <High pull-force type> 100,000 operations min. (10 A resistive load at 250 VAC)
Operating speed		0.05 to 0.5 m/s
Direct opening force *4		<Standard type> 60 N min. <High pull-force type> 80 N min.
Direct opening travel *4		10 mm min.
Contact resistance		25 mΩ max.
Minimum applicable load *5		1 mA resistive load at 5 VDC (N-level reference value)
Rated insulation voltage (U_i)		300 V
Rated frequency		50/60 Hz
Protection against electric shock		Class II (double insulation)
Pollution degree (operating environment)		3 (EN60947-5-1)
Impulse withstand voltage (EN60947-5-1)	Between terminals of same polarity	2.5 kV
	Between terminals of different polarity	4 kV
	Between each terminal and non-current carrying metallic parts	6 kV
Insulation resistance		100 MΩ min.
Contact gap		2 × 2 mm min.
Vibration resistance	Malfunction	10 to 55 Hz, 0.75 mm single amplitude
Shock resistance	Destruction	1,000 m/s ² min.
	Malfunction	300 m/s ² min.
Conditional short-circuit current		100 A (EN60947-5-1)
Conventional free air thermal current (I_{th})		10 A (EN60947-5-1)
Ambient operating temperature		-30 to 70°C (with no icing)
Ambient operating humidity		95% max.
Weight		Approx. 96 g (D4NS-1CF)

Note: 1. The above values are initial values.

2. The Switch contacts can be used with either standard loads or microloads. Once the contacts have been used to switch a load, however, they cannot be used to switch smaller loads. The contact surfaces will become rough once they have been used and contact reliability for smaller loads may be reduced.

***1.** The degree of protection is tested using the method specified by the standard (EN60947-5-1). Confirm that sealing properties are sufficient for the operating conditions and environment beforehand. Although the switch box is protected from dust or water penetration, do not use the D4NS in places where foreign material may enter through the key hole on the head, otherwise Switch damage or malfunctioning may occur.

***2.** The durability is for an ambient temperature of 5 to 35°C and an ambient humidity of 40% to 70%. For more details, consult your OMRON representative.

***3.** Do not pass the 3 A, 250 VAC load through more than 2 circuits.

***4.** These figures are minimum requirements for safe operation.

***5.** This value will vary with the switching frequency, environment, and reliability level. Confirm that correct operation is possible with the actual load beforehand.

Structure and Nomenclature

Structure

D4NS-□A□, D4NS-□B□, D4NS-□E□,
D4NS-□AF-SJ, D4NS-□BF-SJ

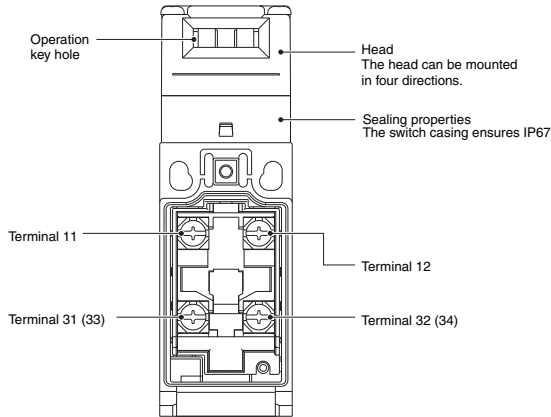

D4NS-□C□, D4NS-□D□, D4NS-□F□,
D4NS-□CF-SJ, D4NS-□DF-SJ

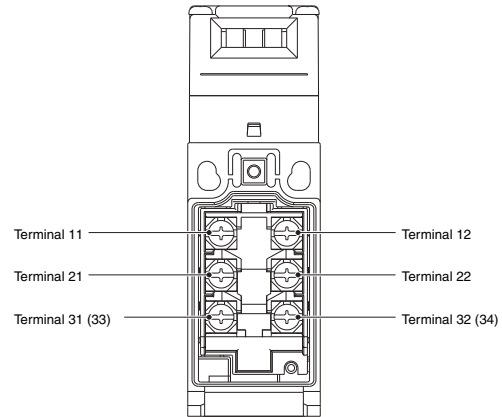

Note: The 2-conduit models have the same terminal arrangement.

Contact Form

Diagrams Show State with Key Inserted.

Model	Contact	Contact form	Operating pattern	Remarks
D4NS-□A□ D4NS-□AF-SJ	1NC/1NO			Only NC contacts 11-12 have a certified direct opening mechanism. (→) The terminals 11-12 and 33-34 can be used as unlike poles.
D4NS-□B□ D4NS-□BF-SJ	2NC			NC contacts 11-12 and 31-32 have a certified direct opening mechanism. (→) The terminals 11-12 and 31-32 can be used as unlike poles.
D4NS-□C□ D4NS-□CF-SJ	2NC/1NO			NC contacts 11-12 and 21-22 have a certified direct opening mechanism. (→) The terminals 11-12, 21-22, and 33-34 can be used as unlike poles.
D4NS-□D□ D4NS-□DF-SJ	3NC			NC contacts 11-12, 21-22, and 31-32 have a certified direct opening mechanism. (→) The terminals 11-12, 21-22, and 31-32 can be used as unlike poles.
D4NS-□E□	1NC/1NO MBB *			Only NC contacts 11-12 have a certified direct opening mechanism. (→) The terminals 11-12 and 33-34 can be used as unlike poles.
D4NS-□F□	2NC/1NO MBB *			NC contacts 11-12 and 21-22 have a certified direct opening mechanism. (→) The terminals 11-12, 21-22 and 33-34 can be used as unlike poles.

* MBB (Make Before Break) contacts have an overlapping structure, so that before the normally closed contact (NC) opens, the normally open contact (NO) closes.

Dimensions

Dimensions and Operating Characteristics

1-Conduit Models

- D4NS-1□F
- D4NS-2□F
- D4NS-4□F
- D4NS-2□F-SJ
- D4NS-4□F-SJ

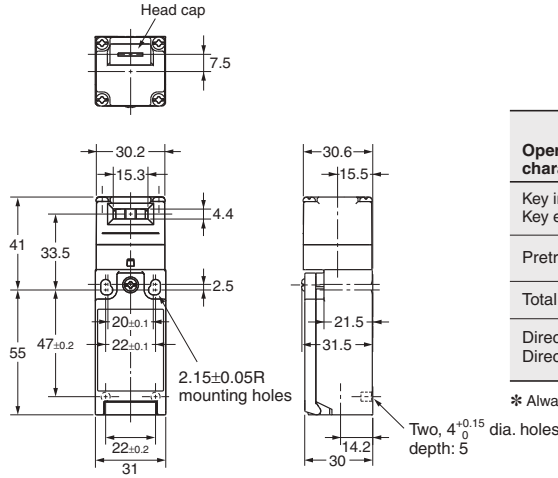
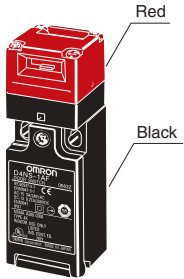

Operating characteristics	Model	D4NS-1□F D4NS-2□F D4NS-4□F	D4NS-2□F-SJ D4NS-4□F-SJ
	Key insertion force Key extraction force		15 N max. 30 N max.
Pretravel (PT)		6±3 mm	6±3 mm
Total travel (TT)		(28 mm)	(28 mm)
Direct opening force * Direct opening stroke *		60 N min. 10 mm min.	80N min. 10mm min.

* Always maintain the above operating characteristics for safe use.

2-Conduit Models

- D4NS-6□F
- D4NS-8□F

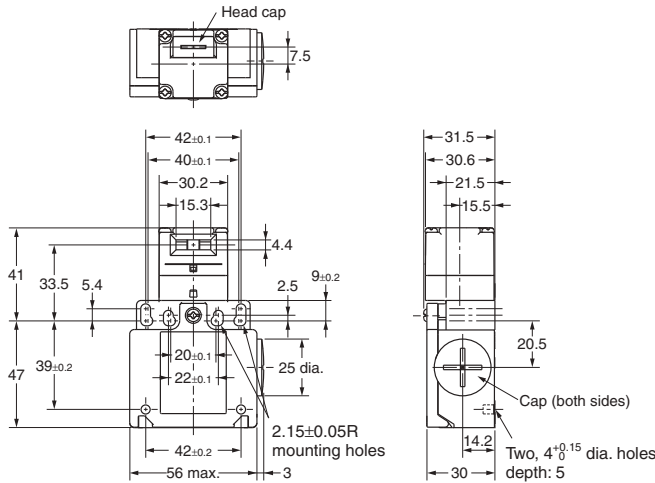
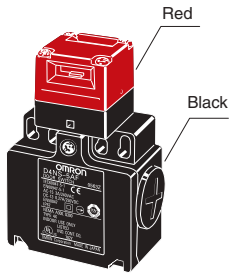

Operating characteristics	Model	D4NS-6□F D4NS-8□F
	Key insertion force Key extraction force	
Pretravel (PT)		6±3 mm
Total travel (TT)		(28 mm)
Direct opening force * Direct opening stroke *		60 N min. 10 mm min.

* Always maintain the above operating characteristics for safe use.

1-Conduit Connector Models

- D4NS-9□F

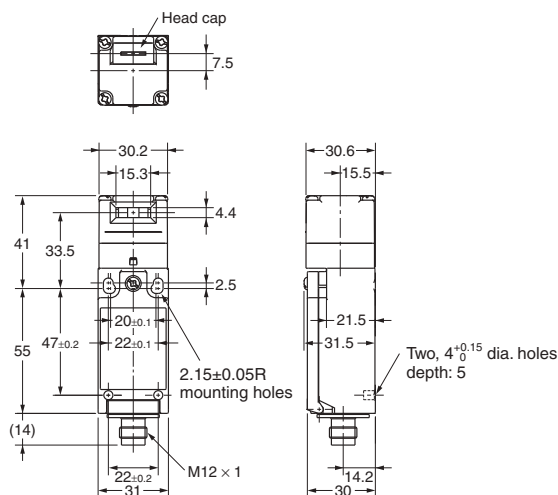
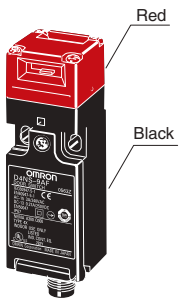

Operating characteristics	Model	D4NS-9□F
	Key insertion force Key extraction force	
Pretravel (PT)		6±3 mm
Total travel (TT)		(28 mm)
Direct opening force * Direct opening stroke *		60 N min. 10 mm min.

* Always maintain the above operating characteristics for safe use.

- Note: 1.** Unless otherwise specified, a tolerance of ±0.4 mm applies to all dimensions.
2. There are fluctuations in the contact ON/OFF timing for Switches with multiple poles (2NC, 2NC/1NO, or 3NC). Confirm performance before application.

Operation Keys

D4DS-K1

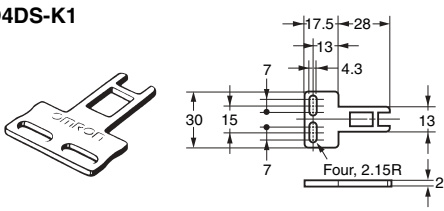

D4DS-K3

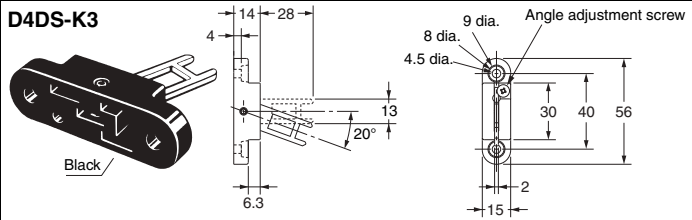

D4DS-K2

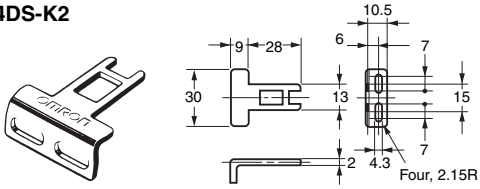

D4DS-K5

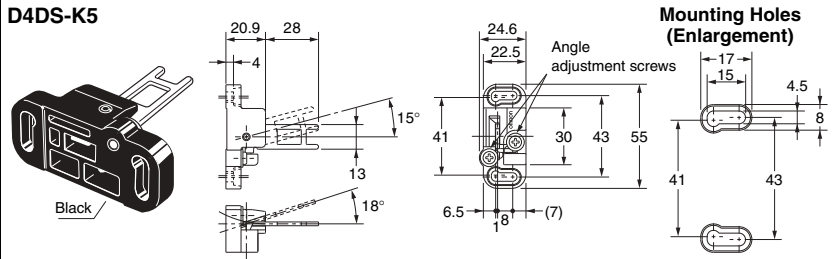

Mounting Holes (Enlargement)

Note: Unless otherwise specified, a tolerance of ± 0.4 mm applies to all dimensions.

With Operation Key Inserted (Relationship between Insertion Radius and Key Hole)

**D4NS-1□F + D4DS-K1
(with Front-inserted Operation Key)**

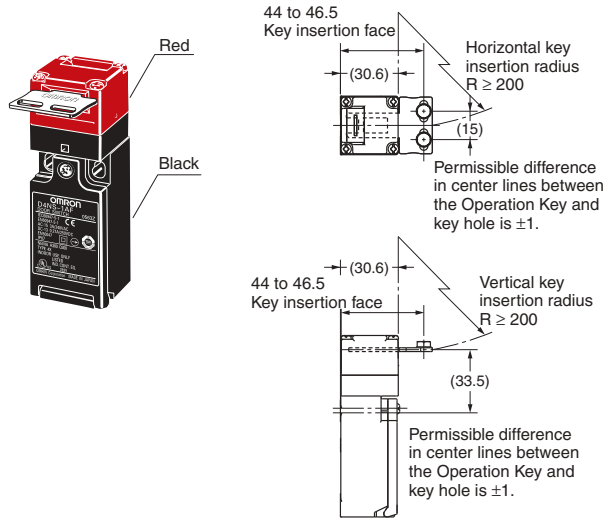

**D4NS-1□F + D4DS-K1
(with Top-inserted Operation Key)**

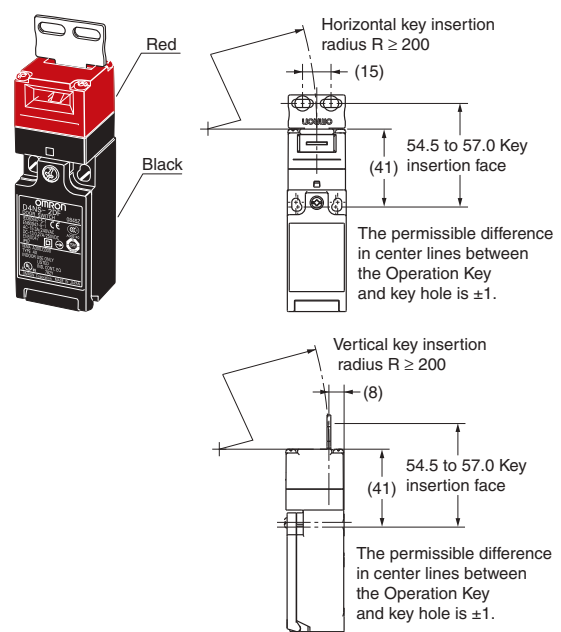

**D4NS-1□F + D4DS-K2
(with Front-inserted Operation Key)**

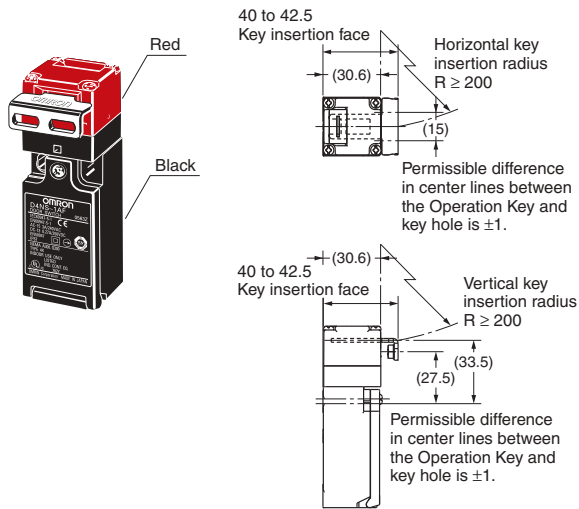

**D4NS-1□F + D4DS-K2
(with Top-inserted Operation Key)**

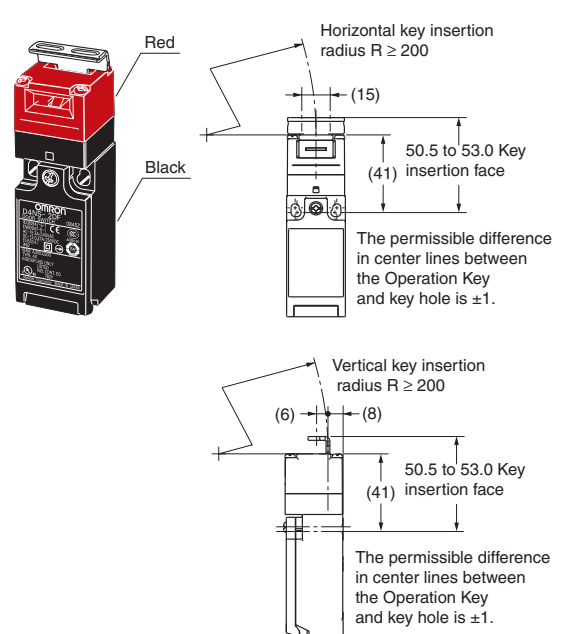

Note: Unless otherwise specified, a tolerance of ± 0.4 mm applies to all dimensions.

**D4NS-1□F + D4DS-K3
(with Front-inserted Operation Key)**

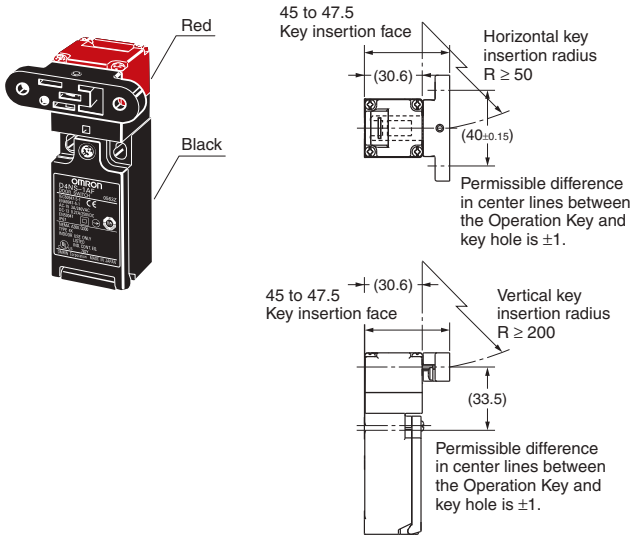

**D4NS-1□F + D4DS-K3
(with Top-inserted Operation Key)**

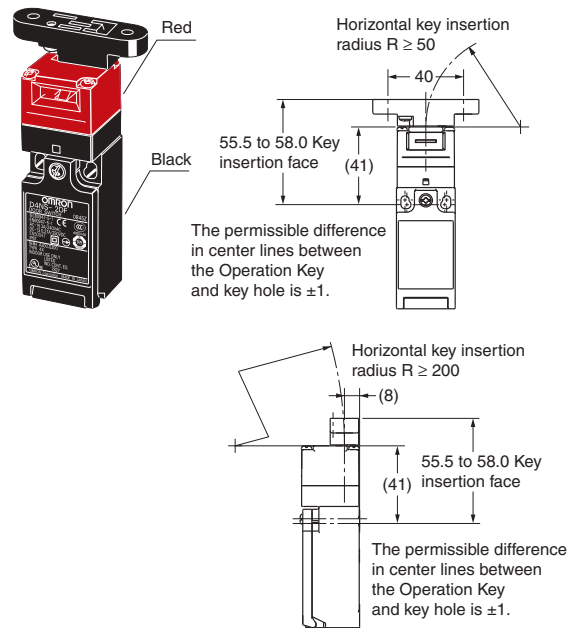

**D4NS-1□F + D4DS-K5
(with Front-inserted Operation Key)**

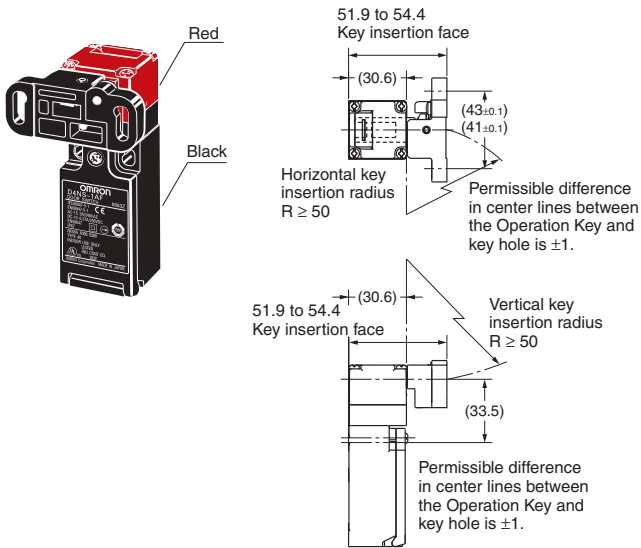

**D4NS-1□F + D4DS-K5
(with Top-inserted Operation Key)**

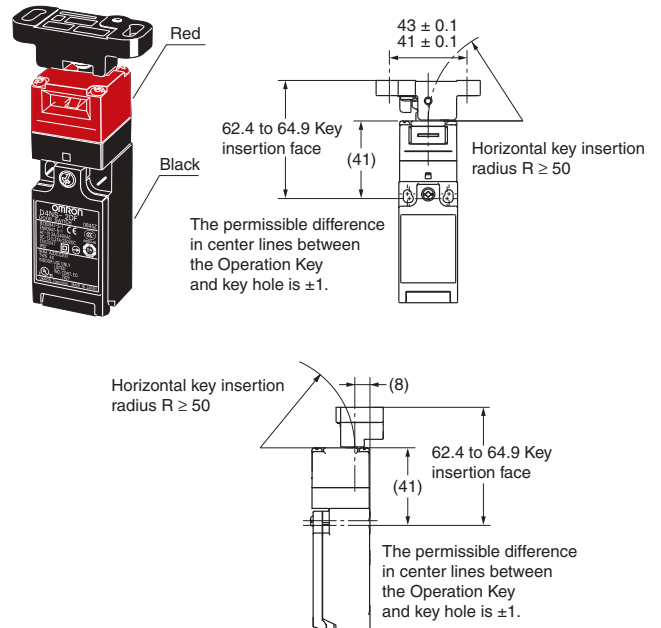

Note: Unless otherwise specified, a tolerance of ± 0.4 mm applies to all dimensions.

Safety Precautions

Refer to the “Precautions for All Switches” and “Precautions for All Safety Door Switches”.

CAUTION

Electric shock may occasionally occur.
Do not use metal connectors or metal conduits.



Precautions for Safe Use

- Do not use the Switch submerged in oil or water or in locations continuously subject to splashes of oil or water. Doing so may result in oil or water entering the Switch. (The IP67 degree of protection of the Switch specifies the amount of water penetration after the Switch is submerged in water for a certain period of time.)
- Always attach the cover after completing wiring and before using the Switch. Also, do not turn ON the Switch with the cover open. Doing so may result in electric shock.
- Do not switch circuits for two or more standard loads (250 VAC, 3 A). Doing so may adversely affect insulation performance.

Stopper Installation

Do not use a Switch as a stopper. Be sure to install a stopper as shown in the following illustration to ensure that the base of the Operation Key does not strike the Head, and adjust the stopper to be within the setting zone (0.5 to 3 mm) of the base of the Operation Key. Do not subject the Switch to a shock that exceeds the Switch's shock resistance of 1,000 m/s².

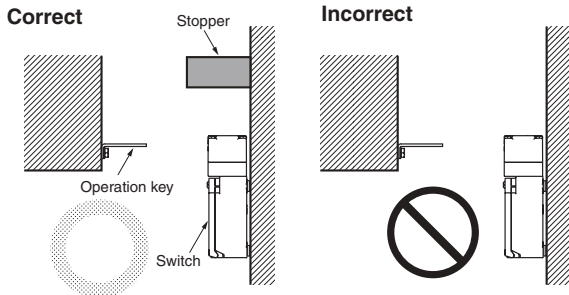

Precautions for Correct Use

The Switch contacts can be used with either standard loads or microloads. Once the contacts have been used to switch a load, however, they cannot be used to switch smaller loads. The contact surfaces will become rough once they have been used and contact reliability for smaller loads may be reduced.

Mounting Method

Appropriate Tightening Torque

- Loose screws may result in malfunction. Tighten the screws to the specified torques.

Terminal screw	0.6 to 0.8 N·m
Cover mounting screw	0.5 to 0.7 N·m
Head mounting screw	0.5 to 0.6 N·m
Operation Key mounting screw	2.4 to 2.8 N·m
Body mounting screw	0.5 to 0.7 N·m
Connector	1.8 to 2.2 N·m
Cap screw	1.3 to 1.7 N·m

- When loosening a screw with an electrical screwdriver or similar tool while pressing down on the screw head, do not continue turning the screw past the point where the threads disengage. Doing so may strip the end of the threads.

Mounting Holes

- Use M4 screws and spring washers to mount the Switch and Operation Key, and tighten the screws to a suitable torque. To ensure safety, use screws that cannot be easily removed or another means to prevent the Switch and Operation Key from easily being removed.
- As shown below, two studs with a maximum height of 4.8 mm and a diameter of 4^{-0.05}/_{-0.15} mm can be provided, the studs inserted into the holes on the bottom of the Switch, and the Switch secured at four locations to increase the mounting strength.

Switch Mounting Holes and Studs

- 1-Conduit Modules

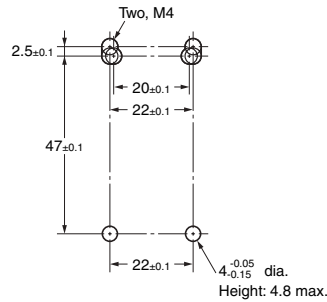

Operation Key Mounting Holes

- Horizontal/Vertical Mounting (D4DS-K1/-K2)

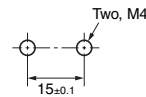

- Horizontal Adjustable Mounting (D4DS-K3)

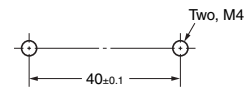

- 2-Conduit Modules

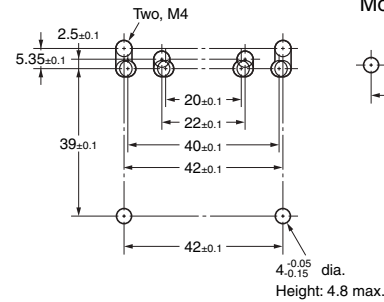

- Horizontal/Vertical Adjustable Mounting (D4DS-K5)

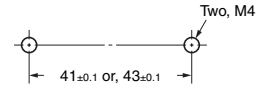

- Set the Operation Key so that it is within 1 mm of the center of the key hole. If the Operation Key is offset or at an angle, accelerated wear or breaking may result.
- Observe the specified insertion radius for the Operation Key and insert it in a direction perpendicular to the key hole.

Head Direction

- The rotation of the Switch head may be adjusted to any of the four directions by loosening the head mounting screws at the four corners of the head. Make sure that no foreign materials enter through the head.
- Do not insert or remove the Operation Key with the Switch head removed. Doing so may make it impossible to insert the Operation Key.

Securing the Door

When the door is closed (with the Operation Key inserted), the Operation Key may exceed the set zone because of, for example, the door's own weight, machine vibration, or the door cushion rubber. Secure the door with a stopper so that the Operation Key remains within the set zone.

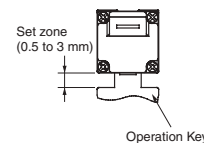

Wiring

- When connecting with insulation tubes and M3.5 crimp terminals, connect the terminals as shown in the following figure and wire without overriding to the case and the cover. Adequate conductor size is AWG 20 to AWG18 (0.5 to 0.75 mm²). Prepare lead wires using the lengths given in the following diagrams. If lead wires are too long, they will press against the cover causing the cover to not close properly.

1-Conduit Models with 3 Poles

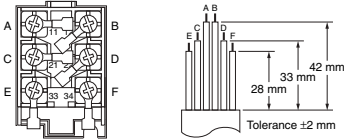

2-Conduit Models with 3 Poles

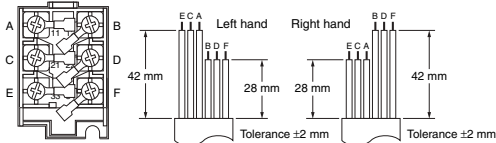

- Do not push the crimp terminal and the likes into the opening between the parts to prevent the case from being broken and deformed.
- Use terminals having the thickness of 0.5 mm or less to avoid the contact between the terminal and the Switch case inside.

<Reference>

The crimp terminals listed below have a thickness of 0.5 mm or less.

Manufacture	Type
J.S.T. Mfg Co.	FN0.5-3.7 (F Type)
	N0.5-3.7 (Straight Type)

J.S.T is a Japanese manufacturer.

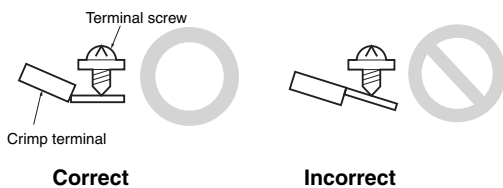
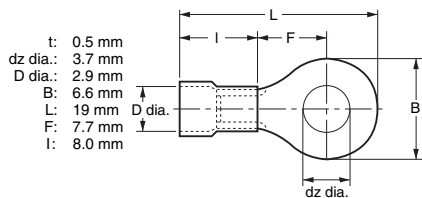

Pin arrangement of connector type

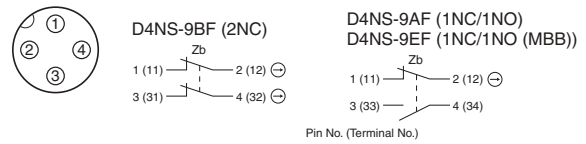

- Suitable socket is XS2F-D421 series (OMRON).
- Refer to the Connector Catalog for corresponding Socket pin numbers and lead wire colors.

Socket Tightening (Models with Connectors)

- Turn the tightening screws on the Socket by hand and tighten them until the gap between the Socket and Plug essentially disappears.
- Make sure that the Socket's connector is tightened securely, otherwise the rated degree of protection (IP67) of the D4NS may not be maintained, or the Socket connector may be loosened by vibration.

Conduit Opening

- Use cables with suitable diameters for the connector being used.
- When wiring, place the enclosed cap screw on unused conduit openings (for 2-Conduit Switches) and tighten them to the suitable tightening torque.

Recommended Connectors

Use the connector with thread section of 9 mm long or less. If a connector with a longer thread section is used, the protruding part may interfere with the other parts inside the body. Use the connectors listed below to ensure IP67 degree of protection.

Size	Manufacture	Model	Applicable cable diameter
G1/2	LAPP	ST-PF1/2 5380-1002	6.0 to 12.0 mm
Pg13.5	LAPP	S-13.5 5301-5030	6.0 to 12.0 mm
M20	LAPP	ST-M20 × 1.5 5311-1020	7.0 to 13.0 mm

When use LAPP's products, use together with a Seal Packing which is sold separately (Type names, JPK-16, GP-13.5, or GPM20) and tighten with proper tightening torque.

- LAPP is a German manufacturer.

Read and Understand This Catalog

Please read and understand this catalog before purchasing the products. Please consult your OMRON representative if you have any questions or comments.

Warranty and Limitations of Liability

WARRANTY

OMRON's exclusive warranty is that the products are free from defects in materials and workmanship for a period of one year (or other period if specified) from date of sale by OMRON.

OMRON MAKES NO WARRANTY OR REPRESENTATION, EXPRESS OR IMPLIED, REGARDING NON-INFRINGEMENT, MERCHANTABILITY, OR FITNESS FOR PARTICULAR PURPOSE OF THE PRODUCTS. ANY BUYER OR USER ACKNOWLEDGES THAT THE BUYER OR USER ALONE HAS DETERMINED THAT THE PRODUCTS WILL SUITABLY MEET THE REQUIREMENTS OF THEIR INTENDED USE. OMRON DISCLAIMS ALL OTHER WARRANTIES, EXPRESS OR IMPLIED.

LIMITATIONS OF LIABILITY

OMRON SHALL NOT BE RESPONSIBLE FOR SPECIAL, INDIRECT, OR CONSEQUENTIAL DAMAGES, LOSS OF PROFITS OR COMMERCIAL LOSS IN ANY WAY CONNECTED WITH THE PRODUCTS, WHETHER SUCH CLAIM IS BASED ON CONTRACT, WARRANTY, NEGLIGENCE, OR STRICT LIABILITY.

In no event shall the responsibility of OMRON for any act exceed the individual price of the product on which liability is asserted.

IN NO EVENT SHALL OMRON BE RESPONSIBLE FOR WARRANTY, REPAIR, OR OTHER CLAIMS REGARDING THE PRODUCTS UNLESS OMRON'S ANALYSIS CONFIRMS THAT THE PRODUCTS WERE PROPERLY HANDLED, STORED, INSTALLED, AND MAINTAINED AND NOT SUBJECT TO CONTAMINATION, ABUSE, MISUSE, OR INAPPROPRIATE MODIFICATION OR REPAIR.

Application Considerations

SUITABILITY FOR USE

OMRON shall not be responsible for conformity with any standards, codes, or regulations that apply to the combination of products in the customer's application or use of the products.

At the customer's request, OMRON will provide applicable third party certification documents identifying ratings and limitations of use that apply to the products. This information by itself is not sufficient for a complete determination of the suitability of the products in combination with the end product, machine, system, or other application or use.

The following are some examples of applications for which particular attention must be given. This is not intended to be an exhaustive list of all possible uses of the products, nor is it intended to imply that the uses listed may be suitable for the products:

- Outdoor use, uses involving potential chemical contamination or electrical interference, or conditions or uses not described in this catalog.
- Nuclear energy control systems, combustion systems, railroad systems, aviation systems, medical equipment, amusement machines, vehicles, safety equipment, and installations subject to separate industry or government regulations.
- Systems, machines, and equipment that could present a risk to life or property.

Please know and observe all prohibitions of use applicable to the products.

NEVER USE THE PRODUCTS FOR AN APPLICATION INVOLVING SERIOUS RISK TO LIFE OR PROPERTY WITHOUT ENSURING THAT THE SYSTEM AS A WHOLE HAS BEEN DESIGNED TO ADDRESS THE RISKS, AND THAT THE OMRON PRODUCTS ARE PROPERLY RATED AND INSTALLED FOR THE INTENDED USE WITHIN THE OVERALL EQUIPMENT OR SYSTEM.

PROGRAMMABLE PRODUCTS

OMRON shall not be responsible for the user's programming of a programmable product, or any consequence thereof.

Disclaimers

CHANGE IN SPECIFICATIONS

Product specifications and accessories may be changed at any time based on improvements and other reasons.

It is our practice to change model numbers when published ratings or features are changed, or when significant construction changes are made. However, some specifications of the products may be changed without any notice. When in doubt, special model numbers may be assigned to fix or establish key specifications for your application on your request. Please consult with your OMRON representative at any time to confirm actual specifications of purchased products.

DIMENSIONS AND WEIGHTS

Dimensions and weights are nominal and are not to be used for manufacturing purposes, even when tolerances are shown.

PERFORMANCE DATA

Performance data given in this catalog is provided as a guide for the user in determining suitability and does not constitute a warranty. It may represent the result of OMRON's test conditions, and the users must correlate it to actual application requirements. Actual performance is subject to the OMRON Warranty and Limitations of Liability.

ERRORS AND OMISSIONS

The information in this document has been carefully checked and is believed to be accurate; however, no responsibility is assumed for clerical, typographical, or proofreading errors, or omissions.

2012.1

In the interest of product improvement, specifications are subject to change without notice.

OMRON Corporation
Industrial Automation Company

<http://www.ia.omron.com/>

(c)Copyright OMRON Corporation 2012 All Right Reserved.