

Presentation of the range

The RXM Optimum miniature relay range comprises:

- 1 5 A relay with 2 C/O contacts or 3 A relays with 4 C/O contacts.
The relays have the same dimensions.
- 2 Socket with mixed contact terminals.
- 3 Metal maintaining clamps (accessories).



Relay description

- 1 Area by which the product can be easily gripped.
- 2 Mechanical "relay status" indicator.
- 3 LED (depending on version) indicating the relay status.
- 4 Four notches for rail mounting adapter or panel mounting adapter with fixing lugs.
- 5 Eight or fourteen Faston type pins.

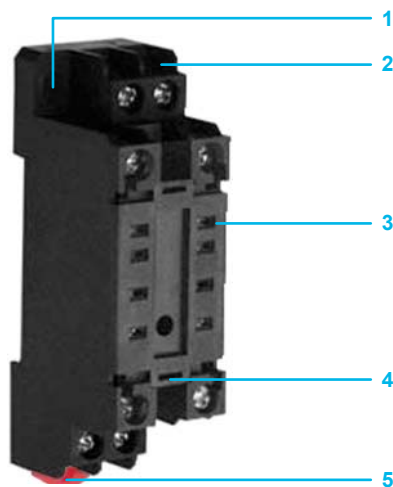

Socket description

- 1 Two fixing holes for panel mounting.
- 2 Connection by screw clamp terminals.
- 3 Eight or fourteen female contacts for the relay pins.
- 4 Two fixing holes for metal maintaining clamp.
- 5 Locating slot for mounting on DIN rail with fixing clip.

General characteristics

Conforming to standards			CE, ROHS, IEC/EN 61810-1 (iss.2)
Product certifications			None
Ambient air temperature around the device	Storage	°C	- 40... + 85
	Operation	°C	- 40... + 55
Vibration resistance conforming to IEC/EN60068-2-6	Operating		3 gn (10...50 Hz)
	Not operating		6 gn (10...50 Hz)
Degree of protection conforming to IEC/EN 60529			IP 40
Shock resistance conforming to IEC/EN 60068-2-27	Opening		10 gn
	Closing		5 gn
Protection category			RT I
Mounting position			Any

Insulation characteristics

Rated insulation voltage (Ui)	V	250 (IEC)	
Rated impulse withstand voltage (Uimp)	kV	3.6 (1.2/50 μs)	
Dielectric strength (rms voltage)	Between coil and contact	~ V	2000
	Between poles	~ V	2000
	Between contacts	~ V	1000

Contact characteristics

Relay type			RXM 2LB●●●	RXM 4LB●●●
Number and type of contacts			2 C/O	4 C/O
Contact materials			Silver Alloy	Silver Alloy
Conventional thermal current (Ith)	For ambient temperature ≤55 °C	A	5	3
Rated operational current in utilisation categories AC-1 and DC-1	Conforming to IEC	N/O	5	3
		N/C	2.5	1.5
Minimum switchable current		mA	10	
Switching voltage	Maximum	V	---/~ 250	
	Minimum	V	17	
Rated load (resistive)		A	5 / 250 VAC	3 / 250 VAC
		A	5 / 28 VDC	3 / 28 VDC
Switching capacity	Maximum	~	VA 1250	750
			W 140	84
	Minimum	mW	170	170
Maximum operating rate in operating cycles/hour	No-load		18 000	
	Under load		1200	
Utilisation coefficient			20 %	
Mechanical durability	In millions of operating cycles		10	
Electrical durability In millions of operating cycles	Resistive load		0.1	
	Inductive load		See curves below	

Electrical durability of contacts

For 2 poles relay

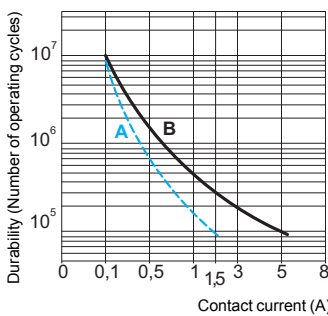

For 4 poles relay

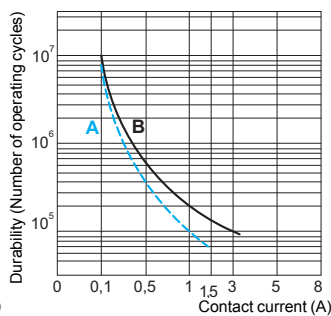

A Inductive load
B Resistive load

Maximum switching capacity

For 2 poles relay

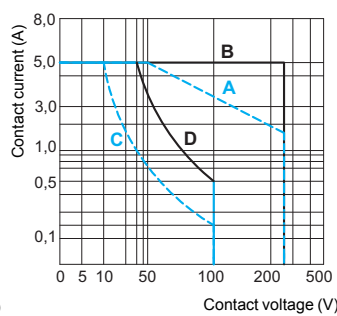

For 4 poles relay

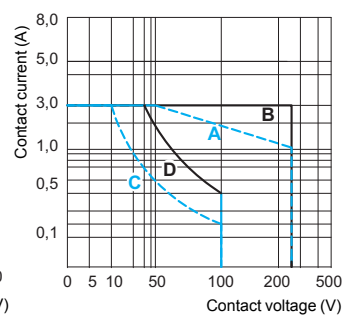

A Inductive load ~
B Resistive load ~
C Inductive load ---
D Resistive load ---

Durability (inductive load) = durability (resistive load) x reduction coefficient.

Coil characteristics										
Average consumption		~	VA	1.2						
		---	W	0,9						
Drop-out voltage threshold		~		≥ 0.15 Uc						
		---		≥ 0.1 Uc						
Operating time (response time)	Between coil energisation and making of the On-delay contact	~	ms	20						
		---	ms	20						
	Between coil de-energisation and making of the Off-delay contact	~	ms	20						
		---	ms	20						
Control circuit voltage Uc			V	12	24	36	48	110	120	230
Relay control voltage codes				JD	BD	CD	ED	FD	–	–
DC supply	Average resistance at 20 °C ± 10%		Ω	160	630	1500	2600	11000	–	–
	Operating voltage limits	Min.	V	9.6	19.2	28.8	38.4	88	–	–
		Max.	V	13.2	26.4	39.6	52.8	121	–	–
Relay control voltage codes				–	B7	–	–	–	F7	P7
AC supply	Average resistance at 20 °C ± 15%		Ω	–	160	–	–	–	4500	15000
	Operating voltage limits	Min.	V	–	19.2	–	–	–	96	184
		Max.	V	–	26.4	–	–	–	132	253
Socket characteristics										
Socket Type				RXZ E1M2C			RXZ E1M4C			
Relay Type				RXM 2●●●●●			RXM 2●●●●●, RXM 4●●●●●			
Contact terminal arrangement				Mixed						
Wire connection method				Screw clamp						
Width			mm	22.5			29			
Product certifications				None						
Conformity to standards				CE, ROHS, IEC 61984						
Electrical Ratings										
Conventional Thermal Current (Ith)			A	7						
Nominal Voltage Rating			V	250 (IEC)						
Dielectric Strength										
Output to Adjacent Output Terminals			Vrms	2 500						
Output to Input Terminals			Vrms	2 500						
General Characteristics										
Temperature range	Operating		°C	- 40...+ 55						
	Storage		°C	- 55...+ 85						
Degree of protection			Conforming to IEC/EN 60529			IP 20				
Connection	Solid cable without cable end	1 conductor	mm ²	0.5...1.5						
			AWG	20...16						
		2 conductors	mm ²	0.5...1.5						
			AWG	20...16						
	Flexible cable with cable end	1 conductor	mm ²	0.25...1						
			AWG	22...17						
2 conductors		mm ²	0.25...1							
		AWG	22...17							
Screw Size			mm	M3						
Maximum tightening torque			Nm	0.8 (M3 Screw)						
Mounting				35 mm DIN Rail / Panel						
DIN Rail locking method				Red Plastic Clip						
Terminal Marking				IEC, NEMA						
Relay fixing plastic clip compatible				No			No			
Relay fixing metal clip compatible				Yes			Yes			
Protection modules				No			No			
Clip-In legend				No			No			



RXM●LB●●●



RXZ E1M●C



RXZ 420

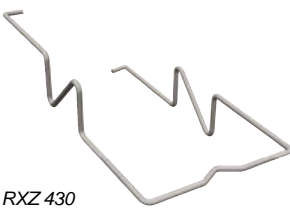

RXZ 430

References

Miniature relays without lockable test-button, with LED (sold in lots of 10)

Control circuit voltage	Number and type of contacts - Thermal current (Ith)			
	2 C/O - 5 A		4 C/O - 3 A	
	Unit reference	Weight	Unit reference	Weight
V		kg		kg
--- 12	RXM 2LB2JD	0.033	RXM 4LB2JD	0.035
--- 24	RXM 2LB2BD	0.032	RXM 4LB2BD	0.034
--- 36	RXM 2LB2CD	0.034	RXM 4LB2CD	0.036
--- 48	RXM 2LB2ED	0.033	RXM 4LB2ED	0.035
--- 110	RXM 2LB2FD	0.031	RXM 4LB2FD	0.033
~ 24	RXM 2LB2B7	0.033	RXM 4LB2B7	0.035
~ 120	RXM 2LB2F7	0.032	RXM 4LB2F7	0.033
~ 230	RXM 2LB2P7	0.031	RXM 4LB2P7	0.032

Miniature relays without lockable test-button, without LED (sold in lots of 10)

Control circuit voltage	Number and type of contacts - Thermal current (Ith)			
	2 C/O - 5 A		4 C/O - 3 A	
	Unit reference	Weight	Unit reference	Weight
V		kg		kg
--- 12	RXM 2LB1JD	0.032	RXM 4LB1JD	0.034
--- 24	RXM 2LB1BD	0.032	RXM 4LB1BD	0.033
--- 48	RXM 2LB1ED	0.033	RXM 4LB1ED	0.034
~ 24	RXM 2LB1B7	0.033	RXM 4LB1B7	0.034
~ 120	RXM 2LB1F7	0.031	RXM 4LB1F7	0.033
~ 230	RXM 2LB1P7	0.030	RXM 4LB1P7	0.032

Sockets

(sold in lots of 10)

Contact terminal arrangement	Connection	Relay type	Unit reference	Weight kg
Mixed	Screw clamp	RXM2	RXZ E1M2C	0.034
	Screw clamp	RXM2	RXZ E1M4C	0.053
		RXM4		

Accessories

(sold in lots of 10)

Description	For use with	Unit reference	Weight kg
Metal maintaining clamp	RXZ E1M2C	RXZ 420	0.001
	RXZ E1M4C	RXZ 430	0.001

nota: If protection module needed, please used the RZE2● sockets with the associated protection module RXM0. You can find all the details in the RXM●AB range.

Dimensions

Miniature relays

RXM ●●●●●●●●

RXM 2●●●●●

RXM 4●●●●●

Common view

Pin side view

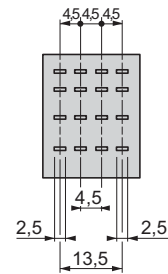
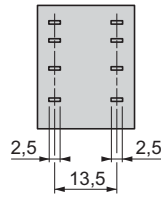
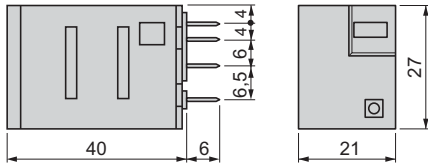

Sockets

RXZ E1M2C

RXZ E1M4C

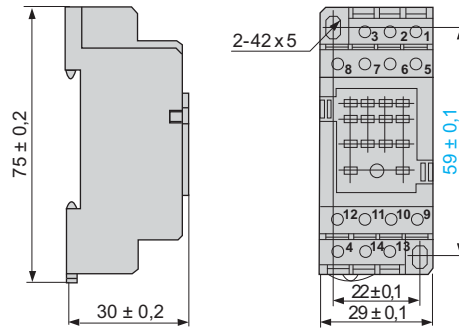
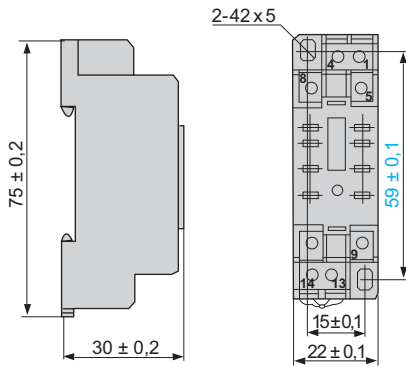

Schemes

Miniature relays

RXM 2●●●●●

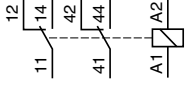

RXM 4●●●●●

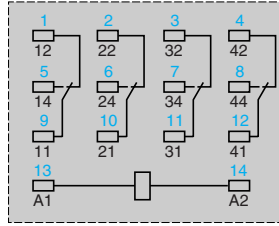
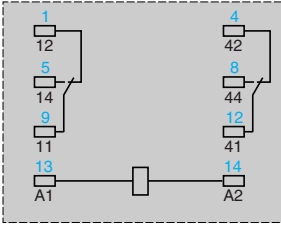
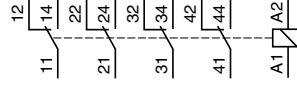

Symbols shown in blue correspond to Nema marking.