

Solid State Relays for Heaters G3PJ

Single-phase SSR with low heat generation carrying up to 25A* provides close mounting (up to 3 SSRs) to allow for downsizing of a control panel.

Models available with time-saving Push-In Plus terminals.

* G3PJ-□25B(-PU)

- SCCR of 10kA (UL 508).
- Surge pass protection improved surge dielectric strength for output currents. (OMRON testing)
- Both Push-In Plus and screw terminal models available.
- Mount to DIN Track or with screws.
- Conforms to cULus and EN standards (TÜV certification).
- RoHS compliant.



For the recent information on models that have been certified for safety standards, refer to your OMRON website.

Refer to *Safety Precautions* on page 5.

Model Number Structure

Model Number Legend

G3PJ - □ □ □ B - □ DC12-24

Basic Model Name 1 2 3 Rated input voltage

1. Rated Load Voltage

- 2: 24 to 240 VAC
- 5: 100 to 480 VAC

2. Rated Load Current for Three Close-mounted SSRs

- 15: 15 A
- 25: 25 A

3. Input Terminal Form

- Blank: Screw terminals
- PU: Push-In Plus terminals

Ordering Information

Input terminal	Output terminal	Insulation method	Operation indicator	Rated input voltage	Zero cross function	Rated load voltage	Rated load current (ambient temperature of 40°C) *		Model
							Close mounting (Three SSRs)	Separate mounting	
Screw terminals	Screw terminals	Phototriac coupler	Yes (orange)	12 to 24 VDC	Yes	24 to 240 VAC	15 A	18 A	G3PJ-215B DC12-24
							25 A	27 A	G3PJ-225B DC12-24
						100 to 480 VAC	15 A	23 A	G3PJ-515B DC12-24
							25 A	27 A	G3PJ-525B DC12-24
Push-In Plus terminal blocks	Screw terminals	Phototriac coupler	Yes (orange)	12 to 24 VDC	Yes	24 to 240 VAC	15 A	18 A	G3PJ-215B-PU DC12-24
							25 A	27 A	G3PJ-225B-PU DC12-24
						100 to 480 VAC	15 A	23 A	G3PJ-515B-PU DC12-24
							25 A	27 A	G3PJ-525B-PU DC12-24

* The applicable load current depends on the ambient temperature. For details, refer to *Load Current vs. Ambient Temperature* in *Engineering Data* on page 3.

G3PJ

Specifications

Ratings

Input (at an Ambient Temperature of 25°C)

Model	Item	Rated voltage	Operating voltage range	Current	Must operate voltage	Must release voltage
G3PJ-2□□B(-PU)/ G3PJ-5□□B(-PU)		12 to 24 VDC	9.6 to 30 VDC	7 mA max.	9.6 VDC max.	1.0 VDC min.

Output

Model	Item	Rated load voltage	Load voltage range	Load current	Inrush current resistance	I ² t
G3PJ-215B(-PU)		24 to 240 VAC 50/60 Hz	19 to 264 VAC 50/60 Hz	Close mounting *: 15 A, Separate mounting: 18 A	150 A (60 Hz, 1 cycle)	260A ² s
G3PJ-225B(-PU)				Close mounting *: 25 A, Separate mounting: 27 A	220 A (60 Hz, 1 cycle)	1,260A ² s
G3PJ-515B(-PU)		100 to 480 VAC 50/60 Hz	75 to 528 VAC 50/60 Hz	Close mounting *: 15 A, Separate mounting: 23 A	150 A (60 Hz, 1 cycle)	1,350A ² s
G3PJ-525B(-PU)				Close mounting *: 25 A, Separate mounting: 27 A	220 A (60 Hz, 1 cycle)	6,600A ² s

* For close mounting of three SSRs.

Characteristics

Item	Model	G3PJ-2□□B(-PU)	G3PJ-5□□B(-PU)
Operate time		1/2 of load power source cycle + 1 ms max.	
Release time		1/2 of load power source cycle + 1 ms max.	
Output ON voltage drop		1.6 V (RMS) max.	1.8 V (RMS) max.
Leakage current		10 mA max. (at 240 VAC)	20 mA max. (at 480 VAC)
Insulation resistance		100 MΩ min. (at 500 VDC)	
Dielectric strength		2,500 VAC 50/60 Hz for 1 min	4,000 VAC 50/60 Hz for 1 min
Vibration resistance		10 to 55 to 10 Hz, 0.35 mm single amplitude (0.7 mm double amplitude) (Mounted to DIN track)	
Shock resistance		Destruction: 300 m/s ² (Mounted to DIN track)	
Ambient storage temperature		-30 to 100°C (with no icing or condensation)	
Ambient operating temperature		-30 to 80°C (with no icing or condensation)	
Ambient operating humidity		45% to 85%	
Weight		Approx. 240 g	

Applicable Standards

cULus and TÜV (EN 60947-4-3)

Pollution category 2

RoHS compliant

Engineering Data

Input Voltage vs. Input Impedance and Input Voltage vs. Input Current

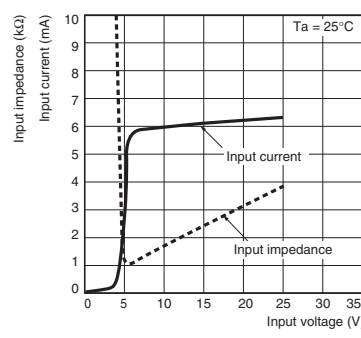
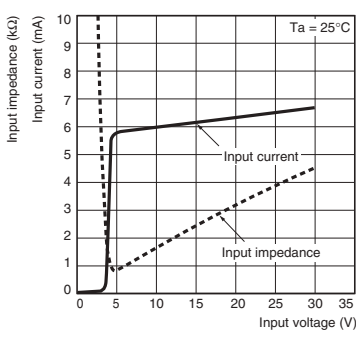

Load Current vs. Ambient Temperature

G3PJ-215B(-PU), G3PJ-225B(-PU)
G3PJ-515B(-PU), G3PJ-525B(-PU)

Close Mounting of Three SSRs

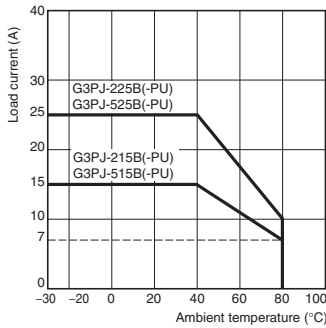

Close Mounting of Eight SSRs

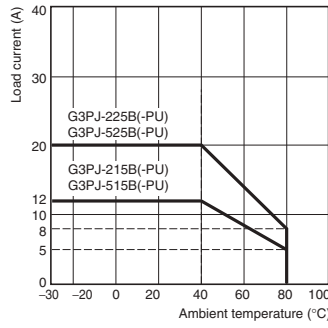

Separate Mounting
(Separated by 10 mm or More)

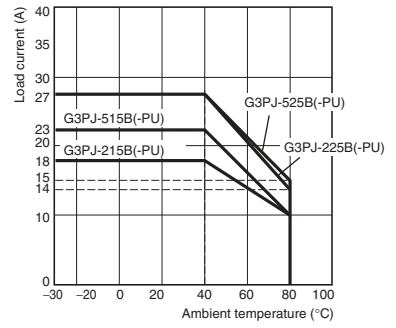

Inrush Current Resistance: Non-repetitive

Keep the inrush current to below the inrush current resistance value (i.e., below the broken line) if it occurs repetitively.

G3PJ-215B(-PU), G3PJ-515B(-PU)

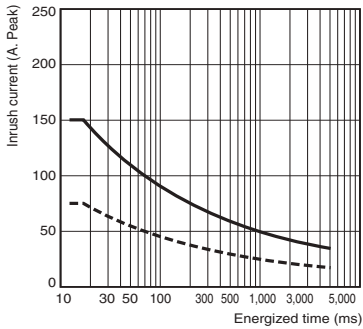

G3PJ-225B(-PU), G3PJ-525B(-PU)

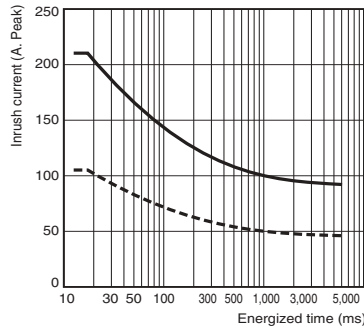

G3PJ

Dimensions

(Unit: mm)

Solid State Relays

SSRs with Screw Terminals

G3PJ-215B

G3PJ-225B

G3PJ-515B

G3PJ-525B

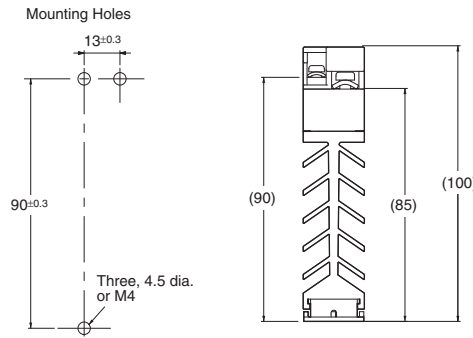
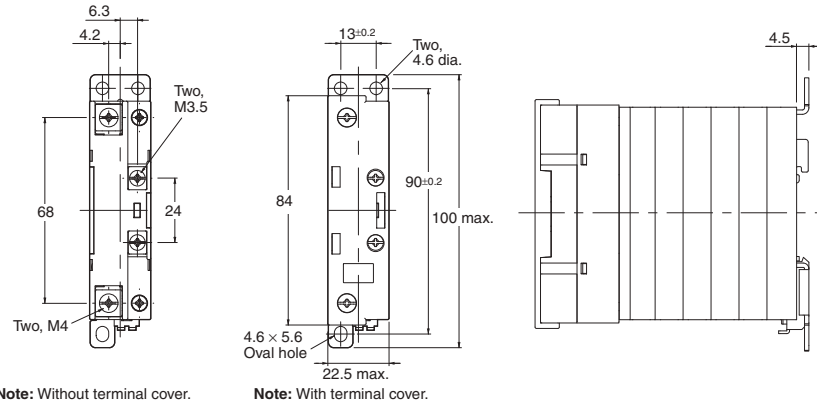

Terminal Arrangement/Internal Circuit Diagram

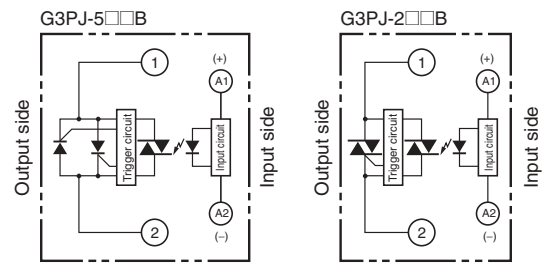

SSRs with Push-In Plus terminal blocks

G3PJ-215B-PU

G3PJ-225B-PU

G3PJ-515B-PU

G3PJ-525B-PU

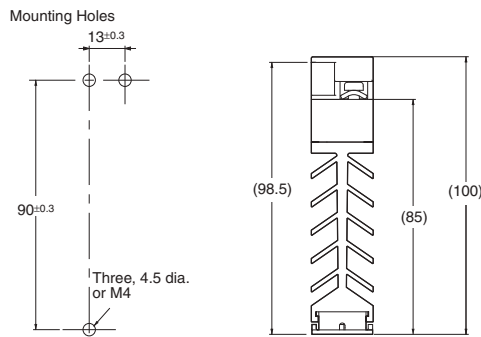
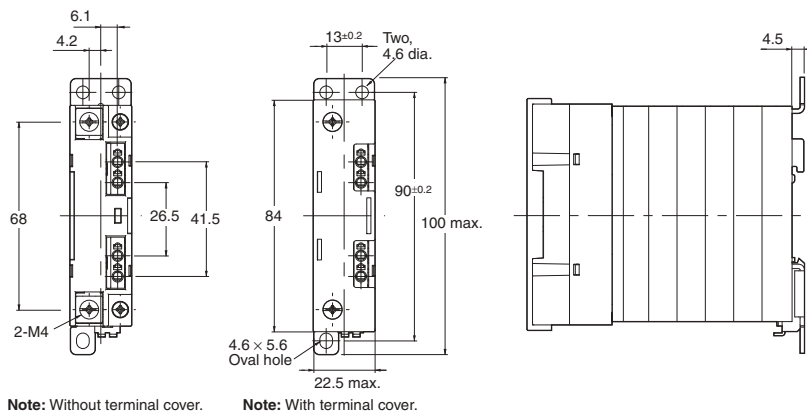

Terminal Arrangement/Internal Circuit Diagram

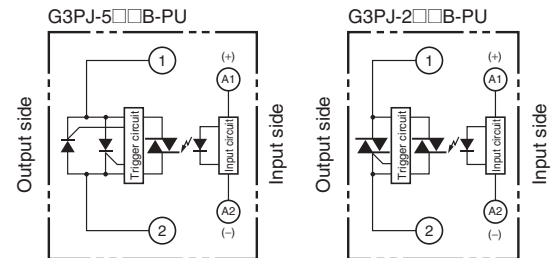



Safety Precautions

Be sure to read the *Safety Precautions for All Solid State Relays* in the website at the following URL:
<http://www.ia.omron.com/>.

Format of Warning Indications

 CAUTION	Indicates a potentially hazardous situation which, if not avoided, may result in minor or moderate injury or in property damage.
Precautions for Safe Use	Indicates supplementary comments on what to do or avoid doing, to use the product safely.
Precautions for Correct Use	Includes operating precautions to ensure that the product will operate properly and that performance and functions will not be adversely affected.

Meaning of Graphic Symbols for Ensuring Product Safety

	Indicates the possibility of electric shock under specific conditions.
	Indicates the possibility of explosion under specific conditions.
	Indicates the possibility of injuries by high temperature under specific conditions.

CAUTION

Minor electrical shock may occasionally occur.
 Do not touch the G3PJ terminal section (i.e., current-carrying parts) while the power is being supplied.
 Also, always attach the cover terminal.



The G3PJ may rupture if short-circuit current flows. As protection against accidents due to short-circuiting, be sure to install protective devices, such as fuses and no-fuse breakers, on the power supply side.



Minor electrical shock may occasionally occur.
 Do not touch the main circuit terminals on the G3PJ immediately after the power supply has been turned OFF. Shock may result due to the electrical charge stored in the built-in snubber circuit.



Minor burns may occasionally occur.
 Do not touch the G3PJ or the heat sink while the power is being supplied or immediately after the power supply has been turned OFF. The G3PJ and heat sink become extremely hot.



Precautions for Safe Use

OMRON constantly strives to improve quality and reliability. The G3PJ, however, use semiconductors, and semiconductors may commonly malfunction or fail. In particular, it may not be possible to ensure safety if the G3PJ are used outside the rated ranges. Therefore, always use the SSRs within the ratings. When using the G3PJ, always design the system to ensure safety and prevent human accidents, fires, and social harm in the event of the G3PJ failure. System design must include measures such as system redundancy, measures to prevent fires from spreading, and designs to prevent malfunction.

Transport

Do not transport the G3PJ under the following conditions. Doing so may result in damage, malfunction, or deterioration of performance characteristics.

- Conditions in which the G3PJ may be subject to water.
- Conditions in which the G3PJ may be subject to high temperature or high humidity.
- Conditions in which the G3PJ is not packaged.
- Do not drop the G3PJ or subject it to abnormal vibration or shock during transportation or mounting. Doing so may result in deterioration of performance, malfunction, or failure.

Operating and Storage Environments

Do not use or store the G3PJ in the following locations. Doing so may result in damage, malfunction, or deterioration of performance characteristics.

- Locations subject to rainwater or water splashes.
- Locations subject to exposure to water, oil, or chemicals.
- Locations subject to high temperature or high humidity.
- Do not store in locations subject to ambient storage temperatures outside the range -30 to 100°C .
- Locations subject to relative humidity outside the range 35% to 85% or locations in which condensation may occur due to rapid changes in temperature.
- Locations subject to corrosive gases.
- Locations subject to dust (especially iron dust) or salts.
- Locations subject to direct sunlight.
- Locations subject to shock or vibration.
- Do not allow solvents such as thinners or gasoline to come into contact with the plastic parts of the G3PJ. A solvent may erase the markings.
- Do not allow oil to come into contact with the terminal cover on the G3PJ. The cover may become milky or crack.

Installation and Handling

- Do not block the movement of the air surrounding the G3PJ or heat sink. Abnormal heating of the G3PJ may result in shorting failures of the output elements or burn damage.
- Do not use the G3PJ if the heat radiation fins have been bent by being dropped. Doing so may result in malfunction due to a reduction in the heat radiation performance.
- Do not handle the G3PJ with oily or dusty (especially iron dust) hands. Doing so may result in malfunction.

Installation and Mounting

- Mount the G3PJ in the specified direction. (Refer to *Mounting* on page 7.) Excessive heat generated by the G3PJ may cause short-circuit failures of the output elements or burn damage.
- Make sure that there is no excess ambient temperature rise due to the heat generation of the G3PJ. If the G3PJ is mounted inside a panel, install a fan so that the interior of the panel is fully ventilated.
- Make sure the DIN track is securely mounted. Otherwise, the G3PJ may fall.
- When mounting the heat sink, do not allow any foreign matter between the heat sink and the mounting surface. Foreign matter may cause malfunction due to a reduction in the heat radiation performance.
- If the G3PJ is mounted directly in a control panel, use aluminum, steel plating, or similar material with a low heat resistance as a substitute for a heat sink. Using the G3PJ mounted in wood or other material with a high heat resistance may result in fire or burning due to heat generated by the G3PJ.
- The G3PJ is heavy. Firmly mount the DIN track and secure both ends with End Plates for DIN-track-mounting models. When mounting the G3PJ directly to a panel, firmly secure it to the panel.

Installation and Wiring

- Use wires that are suited to the load current. Otherwise, excessive heat generated by the wires may cause burning.
- Do not use wires with a damaged outer covering. Otherwise, it may result in electric shock or ground leakage.
- Do not wire any wiring in the same duct or conduit as power or high-tension lines. Otherwise, inductive noise may damage the G3PJ or cause it to malfunction.
- When tightening terminal screws, prevent any non-conducting material from becoming caught between the screws and the tightening surface. Otherwise, excessive heat generated by the terminal may cause burning.
- Do not use the G3PJ with loose terminal screws. Otherwise, excessive heat generated by the wire may cause burning.
- Use suitable wire lengths for wiring. Inductive noise may occasionally cause malfunction, failure, or burn damage.
- Always turn OFF the power supply before performing wiring. Not doing so may cause electrical shock.

Push-In Plus Terminal Block

- Do not wire anything to the release holes.
- Do not tilt or twist a flat-blade screwdriver while it is inserted into a release hole on the terminal block. The terminal block may be damaged.
- Insert a flat-blade screwdriver into the release holes at an angle. The terminal block may be damaged if you insert the screwdriver straight in.
- Do not allow the flat-blade screwdriver to fall out while it is inserted into a release hole.
- Do not bend a wire past its natural bending radius or pull on it with excessive force. Doing so may cause the wire disconnection.
- Do not insert more than one wire into each terminal insertion hole.
- To prevent wiring materials from smoking or ignition, use the wiring materials given in the following table.

Recommended Wire	Stripping length	
	With Ferrules	Without Ferrules
0.25 to 1.5 mm ² / AWG24 to AWG16	10 mm	8 mm

Note: Please use Ferrules with UL certification (R/C).

Installation and Usage

- Do not apply a voltage or current that exceeds the rating to any terminal. Doing so may result in malfunction or burn damage.
- Select a load within the rated values. Not doing so may result in malfunction, failure, or burning.
- Select a power supply within the rated frequencies. Not doing so may result in malfunction, failure, or burning.
- If a surge voltage is applied to the load of the Contactor, a surge bypass(*) will function to trigger the output element. The G3PJ therefore cannot be used for motor loads. Doing so may result in load motor malfunction.

* Surge Bypass

This circuit protects the output circuit from being destroyed. This suppresses the surge energy applied inside the SSR in comparison with a varistor for the main circuit protection. By alleviating electrical stress on the electronic components of the SSR's output circuit, failure and destruction due to surge voltage are suppressed.

Reference value: Surge dielectric strength of 30 kV min.

(Test conditions: 1.2 X 50 μs standard voltage waveform, peak voltage of 30 kV, repeated 50 times according to JIS C5442)

Precautions for Correct Use

The G3PJ in operation may cause an unexpected accident. Therefore it is necessary to test the G3PJ under the variety of conditions that are possible. As for the characteristics of the G3PJ, it is necessary to consider differences in characteristics between individual G3PJ.

The ratings in this catalog are tested values in a temperature range between 15°C and 30°C, a relative humidity range between 25% and 85%, and an atmospheric pressure range between 86 and 106 kPa. It will be necessary to provide the above conditions as well as the load conditions if the user wants to confirm the ratings of specific SSRs.

Causes of Failure

- Tighten each terminal to the torque specified below. Improper tightening may result in abnormal heat generation at the terminal, which may cause burning.

Terminals	Screw terminal diameter	Tightening torque
Input terminals	M3.5	0.59 to 1.18 N·m
Output terminals	M4	0.98 to 1.47 N·m

- Do not supply overvoltage to the input circuits or output circuits. Doing so may result in failure or burning.
- Do not use or store the G3PJ in the following conditions. Doing so may result in deterioration of performance.
 - Locations subject to static electricity or noise
 - Locations subject to strong electric or magnetic fields
 - Locations subject to radioactivity

Mounting

- The G3PJ is heavy. Firmly mount the DIN Track and secure both ends with End Plates for DIN Track mounting models. When mounting the G3PJ directly to a panel, firmly secure it to the panel.

Screw diameter: M4

Tightening torque: 0.98 to 1.47 N·m

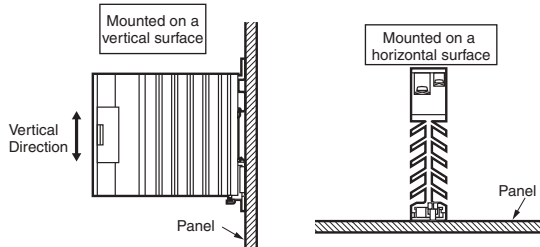

Note: Make sure that the load current is 50% of the rated load current when the G3PJ is mounted horizontally. For details on close mounting, refer to the related information under performance characteristics. Mount the G3PJ in a direction so that the markings read naturally.

Wiring

- When using crimp terminals, refer to the terminal clearances shown below.

Output Terminal Section

15-A and 25-A Models

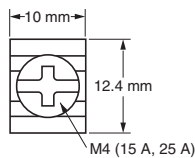

Input Terminal Section

Screw Terminals

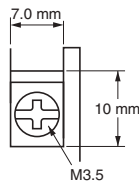

Push-in Plus Terminals



- Make sure that all lead wires are thick enough for the current.
- To isolate the Relay from the power supply, install an appropriate circuit breaker between the power supply and the Relay. Always turn OFF the power supply before wiring the Unit.

Push-In Plus Terminal Block

1. Connecting Wires to the Push-In Plus Terminal Block

Part Names of the Terminal Block

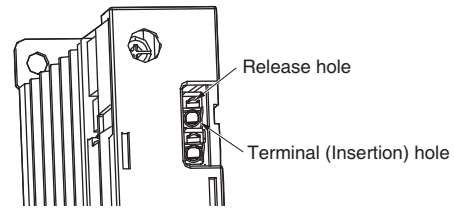

Connecting Wires with Ferrules and Solid Wires

Insert the solid wire or ferrule straight into the terminal block until the end strikes the terminal block.

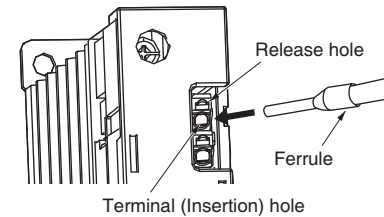

If a wire is difficult to connect because it is too thin, use a flat-blade screwdriver in the same way as when connecting stranded wire.

Connecting Stranded Wires

Use the following procedure to connect the wires to the terminal block.

1. Hold a flat-blade screwdriver at an angle and insert it into the release hole.

The angle should be between 10° and 15°. If the flat-blade screwdriver is inserted correctly, you will feel the spring in the release hole respond.

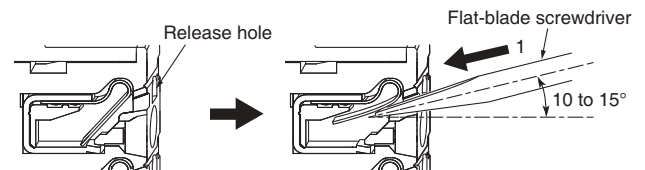

2. With the flat-blade screwdriver still inserted into the release hole, insert the wire into the terminal hole until it strikes the terminal block.

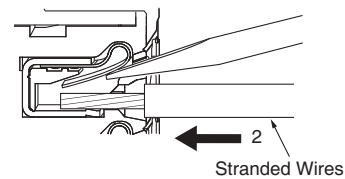

3. Remove the flat-blade screwdriver from the release hole.

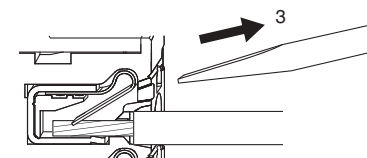

Checking Connections

- After insertion, pull gently on the wire to make sure that it will not come out (i.e., to confirm that it is held by the terminal block).
- To prevent short circuits, insert the stripped part of a stranded or solid wire or the conductive part of a ferrule until it is hidden inside the terminal insertion hole. (See following diagram.)

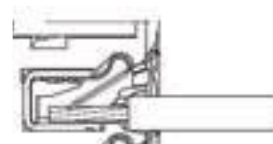

2. Removing Wires from the Push-In Plus Terminal Block

Use the following procedure to remove wires from the terminal block. The same method is used to remove stranded wires, solid wires, and ferrules.

1. Hold a flat-blade screwdriver at an angle and insert it into the release hole.

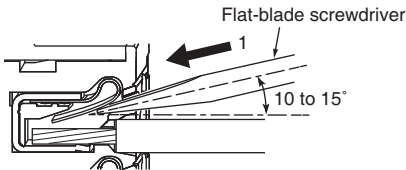

2. With the flat-blade screwdriver still inserted into the release hole, remove the wire from the terminal insertion hole.

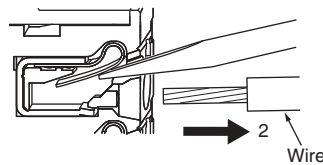

3. Remove the flat-blade screwdriver from the release hole.

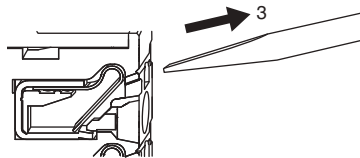

3. Recommended Ferrules and Crimp Tools

Recommended ferrules

Applicable wire		Ferrule Conduct length (mm)	Recommended ferrules		
(mm ²)	(AWG)		Phoenix Contact product	Weidmuller product	Wago product
0.25	24	8	AI0.25-8	H0.25/12	FE-0.25-8N-YE
0.34	22	8	AI0.34-8	H0.34/12	FE-0.34-8N-TQ
0.5	20	8	AI0.5-8	H0.5/14	FE-0.5-8N-WH
0.75	18	8	AI0.75-8	H0.75/14	FE-0.75-8N-GY
1	18	8	AI1-8	H1.0/14	FE-1.0-8N-RD
1.5	16	8	AI1.5-8	H1.5/14	FE-1.5-8N-BK
Recommended crimp tool			CRIMPFOX6	PZ6 roto	Variocrimp4

Note: 1. Make sure that the outer diameter of the wire is smaller than the inner diameter of the insulating sleeve of the recommended ferrule.

2. Make sure that the ferrule processing dimensions conform to the following figure.

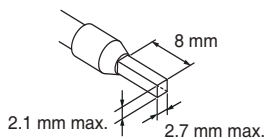

Recommended Flat-blade Screwdriver

Use a flat-blade screwdriver to connect and remove wires.

Use the following flat-blade screwdriver.

The following table shows manufacturers and models as of 2015/Dec.

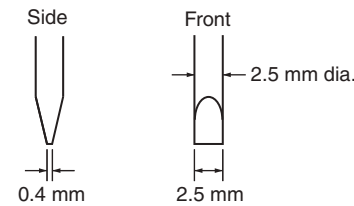

Model	Manufacturer
XW4Z-00B	Omron
ESD0.40X2.5	Wera
SZF 0.4X2.5	Phoenix Contact
0.4X2.5X75 302	Wiha
AEF.2.5X75	Facom
210-719	Wago
SDI 0.4X2.5X75	Weidmuller

Fuses

- Use a quick-burning fuse on the output terminals to prevent accidents due to short-circuiting. Use a fuse with equal or greater performance than those given in the following table.

Recommended Fuse Capacity

Rated G3PJ output current	Applicable SSR	Fuse (IEC 60269-4)
15 A	G3PJ-□15B Series	32 A
25 A	G3PJ-□25B Series	

EMC Ditective Compliance

EMC direcives can be complied with under the following conditions.

1. The G3PJ with Rated Load Voltage of 24 to 240 VAC (2□□B model)
 - A capacitor must be connected to the load power supply.
 - The input cable must be less than 3 m.

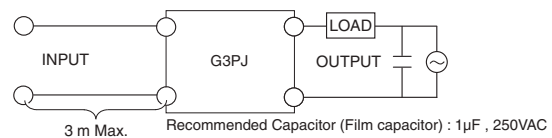

2. The G3PJ with Rated Load Voltage of 100 to 480 VAC (5□□B model)
 - A capacitor must be connected to the input power supply.
 - A capacitor, varistor and toroidal core must be connected to the load power supply.
 - The input cable must be less than 3 m.

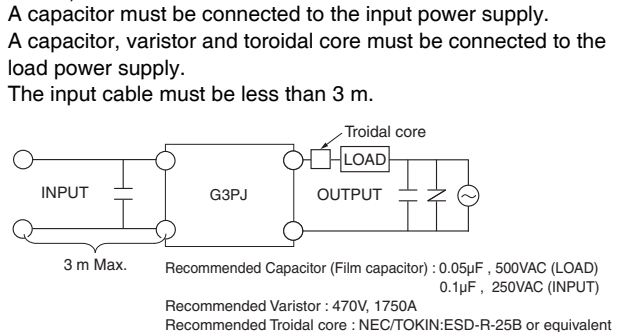

EMI

This is a Class A product (for industrial environments). In a domestic environment, the G3PJ may cause radio interference, in which case the user may be required to take appropriate measures.

Noise and Surge Effects

If noise or an electrical surge occurs that exceeds the malfunction withstand limit for the G3PJ output circuit, the output will turn ON for a maximum of one half cycle to absorb the noise or surge. Confirm that turning the output ON for a half cycle will not cause a problem for the device or system in which the G3PJ is being used prior to actual use. The G3PJ malfunction withstand limit is shown below.

- Malfunction withstand limit (reference value): 500 V

Note: This value was measured under the following conditions.

Noise duration: 100 ns and 1 μs
 Repetition period: 100 Hz
 Noise application time: 3 min

Mounting to Control Panel

If the panel is airtight, heat from the G3PJ will build up inside, which may reduce the current carry ability of the G3PJ or adversely affect other electrical devices. Be sure to install ventilation holes on the top and bottom of the panel.

The G3PJ Mounting Pitch (Panel Mounting)

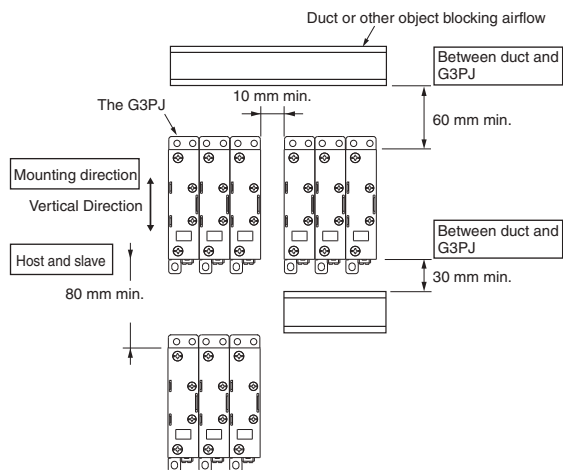

Relationship between the G3PJ and Ducts or Other Objects Blocking Airflow

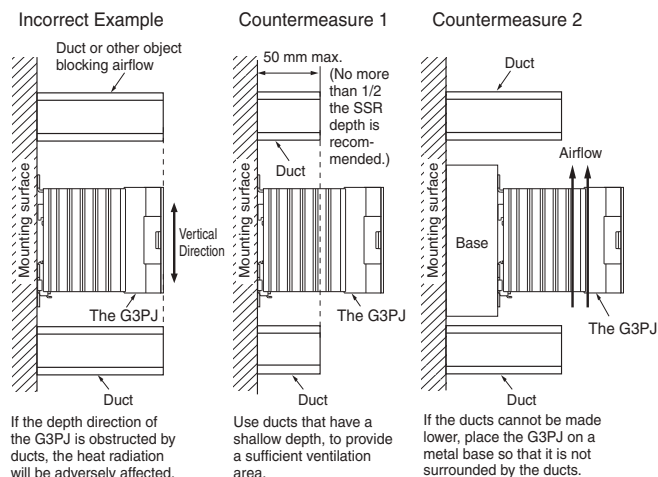

Ventilation Outside the Control Panel

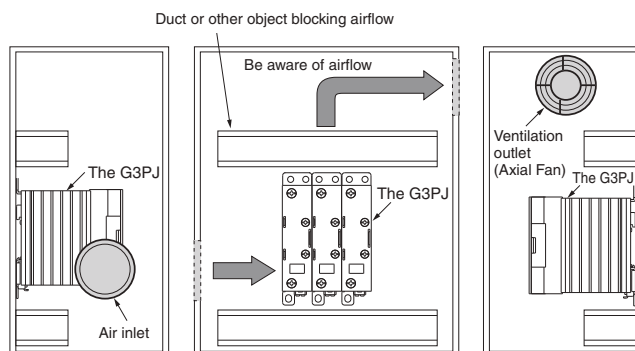

- Note:**
1. If the air inlet or air outlet has a filter, clean the filter regularly to prevent it from clogging to ensure an efficient flow of air.
 2. Do not locate any objects around the air inlet or air outlet, otherwise the objects may obstruct the proper ventilation of the control panel.
 3. A heat exchanger, if used, should be located in front of the G3PJ to ensure the efficiency of the heat exchanger.

G3PJ Ambient Temperature

The rated current of the G3PJ is measured at an ambient temperature of 40°C.

The G3PJ uses a semiconductor to switch the load. This causes the temperature inside the control panel to increase due to heating resulting from the flow of electrical current through the load. The G3PJ reliability can be increased by adding a ventilation fan to the control panel to dispel this heat, thus lowering the ambient temperature of the G3PJ.

(Arrhenius's law suggests that life expectancy is doubled by each 10°C reduction in ambient temperature.)

The G3PJ rated current (A)	15 A	25 A	35 A
Required number of fans per the G3PJ	0.23	0.39	0.54

Example: For 10 G3PJ with load currents of 15 A,
 $0.23 \times 10 = 2.3$

Thus, 3 fans would be required.

- Note:**
1. Size of fans: 92 mm × 92 mm, Air volume: 0.7 m³/min, Ambient temperature of control panel: 30°C
 2. If there are other instruments that generate heat in the control panel in addition to the G3PJ, more ventilation will be required.
 3. Ambient temperature: The temperature that will allow the G3PJ to cool by convection or other means.

Terms and Conditions of Sale

1. **Offer; Acceptance.** These terms and conditions (these "**Terms**") are deemed part of all quotes, agreements, purchase orders, acknowledgments, price lists, catalogs, manuals, brochures and other documents, whether electronic or in writing, relating to the sale of products or services (collectively, the "**Products**") by Omron Electronics LLC and its subsidiary companies ("**Omron**"). Omron objects to any terms or conditions proposed in Buyer's purchase order or other documents which are inconsistent with, or in addition to, these Terms.
2. **Prices; Payment Terms.** All prices stated are current, subject to change without notice by Omron. Omron reserves the right to increase or decrease prices on any unshipped portions of outstanding orders. Payments for Products are due net 30 days unless otherwise stated in the invoice.
3. **Discounts.** Cash discounts, if any, will apply only on the net amount of invoices sent to Buyer after deducting transportation charges, taxes and duties, and will be allowed only if (i) the invoice is paid according to Omron's payment terms and (ii) Buyer has no past due amounts.
4. **Interest.** Omron, at its option, may charge Buyer 1-1/2% interest per month or the maximum legal rate, whichever is less, on any balance not paid within the stated terms.
5. **Orders.** Omron will accept no order less than \$200 net billing.
6. **Governmental Approvals.** Buyer shall be responsible for, and shall bear all costs involved in, obtaining any government approvals required for the importation or sale of the Products.
7. **Taxes.** All taxes, duties and other governmental charges (other than general real property and income taxes), including any interest or penalties thereon, imposed directly or indirectly on Omron or required to be collected directly or indirectly by Omron for the manufacture, production, sale, delivery, importation, consumption or use of the Products sold hereunder (including customs duties and sales, excise, use, turnover and license taxes) shall be charged to and remitted by Buyer to Omron.
8. **Financial.** If the financial position of Buyer at any time becomes unsatisfactory to Omron, Omron reserves the right to stop shipments or require satisfactory security or payment in advance. If Buyer fails to make payment or otherwise comply with these Terms or any related agreement, Omron may (without liability and in addition to other remedies) cancel any unshipped portion of Products sold hereunder and stop any Products in transit until Buyer pays all amounts, including amounts payable hereunder, whether or not then due, which are owing to it by Buyer. Buyer shall in any event remain liable for all unpaid accounts.
9. **Cancellation; Etc.** Orders are not subject to rescheduling or cancellation unless Buyer indemnifies Omron against all related costs or expenses.
10. **Force Majeure.** Omron shall not be liable for any delay or failure in delivery resulting from causes beyond its control, including earthquakes, fires, floods, strikes or other labor disputes, shortage of labor or materials, accidents to machinery, acts of sabotage, riots, delay in or lack of transportation or the requirements of any government authority.
11. **Shipping; Delivery.** Unless otherwise expressly agreed in writing by Omron:
 - a. Shipments shall be by a carrier selected by Omron; Omron will not drop ship except in "break down" situations.
 - b. Such carrier shall act as the agent of Buyer and delivery to such carrier shall constitute delivery to Buyer;
 - c. All sales and shipments of Products shall be FOB shipping point (unless otherwise stated in writing by Omron), at which point title and risk of loss shall pass from Omron to Buyer; provided that Omron shall retain a security interest in the Products until the full purchase price is paid;
 - d. Delivery and shipping dates are estimates only; and
 - e. Omron will package Products as it deems proper for protection against normal handling and extra charges apply to special conditions.
12. **Claims.** Any claim by Buyer against Omron for shortage or damage to the Products occurring before delivery to the carrier must be presented in writing to Omron within 30 days of receipt of shipment and include the original transportation bill signed by the carrier noting that the carrier received the Products from Omron in the condition claimed.
13. **Warranties.** (a) **Exclusive Warranty.** Omron's exclusive warranty is that the Products will be free from defects in materials and workmanship for a period of twelve months from the date of sale by Omron (or such other period expressed in writing by Omron). Omron disclaims all other warranties, express or implied. (b) **Limitations.** OMRON MAKES NO WARRANTY OR REPRESENTATION, EXPRESS OR IMPLIED, ABOUT NON-INFRINGEMENT, MERCHANTABILITY OR FITNESS FOR A PARTICULAR PURPOSE OF THE PRODUCTS. BUYER ACKNOWLEDGES THAT IT ALONE HAS DETERMINED THAT THE PRODUCTS WILL SUITABLY MEET THE REQUIREMENTS OF THEIR INTENDED USE. Omron further disclaims all warranties and responsibility of any type for claims or expenses based on infringement by the Products or otherwise of any intellectual property right. (c) **Buyer Remedy.** Omron's sole obligation hereunder shall be, at Omron's election, to (i) replace (in the form originally shipped with Buyer responsible for labor charges for removal or replacement thereof) the non-complying Product, (ii) repair the non-complying Product, or (iii) repay or credit Buyer an amount equal to the purchase price of the non-complying Product; provided that in no event shall Omron be responsible for warranty, repair, indemnity or any other claims or expenses regarding the Products unless Omron's analysis confirms that the Products were properly handled, stored, installed and maintained and not subject to contamination, abuse, misuse or inappropriate modification. Return of any Products by Buyer must be approved in writing by Omron before shipment. Omron Companies shall not be liable for the suitability or unsuitability or the results from the use of Products in combination with any electrical or electronic components, circuits, system assemblies or any other materials or substances or environments. Any advice, recommendations or information given orally or in writing, are not to be construed as an amendment or addition to the above warranty. See <http://www.omron247.com> or contact your Omron representative for published information.
14. **Limitation on Liability; Etc.** OMRON COMPANIES SHALL NOT BE LIABLE FOR SPECIAL, INDIRECT, INCIDENTAL, OR CONSEQUENTIAL DAMAGES, LOSS OF PROFITS OR PRODUCTION OR COMMERCIAL LOSS IN ANY WAY CONNECTED WITH THE PRODUCTS, WHETHER SUCH CLAIM IS BASED IN CONTRACT, WARRANTY, NEGLIGENCE OR STRICT LIABILITY. Further, in no event shall liability of Omron Companies exceed the individual price of the Product on which liability is asserted.
15. **Indemnities.** Buyer shall indemnify and hold harmless Omron Companies and their employees from and against all liabilities, losses, claims, costs and expenses (including attorney's fees and expenses) related to any claim, investigation, litigation or proceeding (whether or not Omron is a party) which arises or is alleged to arise from Buyer's acts or omissions under these Terms or in any way with respect to the Products. Without limiting the foregoing, Buyer (at its own expense) shall indemnify and hold harmless Omron and defend or settle any action brought against such Companies to the extent based on a claim that any Product made to Buyer specifications infringed intellectual property rights of another party.
16. **Property; Confidentiality.** Any intellectual property in the Products is the exclusive property of Omron Companies and Buyer shall not attempt to duplicate it in any way without the written permission of Omron. Notwithstanding any charges to Buyer for engineering or tooling, all engineering and tooling shall remain the exclusive property of Omron. All information and materials supplied by Omron to Buyer relating to the Products are confidential and proprietary, and Buyer shall limit distribution thereof to its trusted employees and strictly prevent disclosure to any third party.
17. **Export Controls.** Buyer shall comply with all applicable laws, regulations and licenses regarding (i) export of products or information; (iii) sale of products to "forbidden" or other proscribed persons; and (ii) disclosure to non-citizens of regulated technology or information.
18. **Miscellaneous.** (a) **Waiver.** No failure or delay by Omron in exercising any right and no course of dealing between Buyer and Omron shall operate as a waiver of rights by Omron. (b) **Assignment.** Buyer may not assign its rights hereunder without Omron's written consent. (c) **Law.** These Terms are governed by the law of the jurisdiction of the home office of the Omron company from which Buyer is purchasing the Products (without regard to conflict of law principles). (d) **Amendment.** These Terms constitute the entire agreement between Buyer and Omron relating to the Products, and no provision may be changed or waived unless in writing signed by the parties. (e) **Severability.** If any provision hereof is rendered ineffective or invalid, such provision shall not invalidate any other provision. (f) **Setoff.** Buyer shall have no right to set off any amounts against the amount owing in respect of this invoice. (g) **Definitions.** As used herein, "including" means "including without limitation"; and "Omron Companies" (or similar words) mean Omron Corporation and any direct or indirect subsidiary or affiliate thereof.

Certain Precautions on Specifications and Use

1. **Suitability of Use.** Omron Companies shall not be responsible for conformity with any standards, codes or regulations which apply to the combination of the Product in the Buyer's application or use of the Product. At Buyer's request, Omron will provide applicable third party certification documents identifying ratings and limitations of use which apply to the Product. This information by itself is not sufficient for a complete determination of the suitability of the Product in combination with the end product, machine, system, or other application or use. Buyer shall be solely responsible for determining appropriateness of the particular Product with respect to Buyer's application, product or system. Buyer shall take application responsibility in all cases but the following is a non-exhaustive list of applications for which particular attention must be given: (i) Outdoor use, uses involving potential chemical contamination or electrical interference, or conditions or uses not described in this document. (ii) Use in consumer products or any use in significant quantities. (iii) Energy control systems, combustion systems, railroad systems, aviation systems, medical equipment, amusement machines, vehicles, safety equipment, and installations subject to separate industry or government regulations. (iv) Systems, machines and equipment that could present a risk to life or property. Please know and observe all prohibitions of use applicable to this Product. NEVER USE THE PRODUCT FOR AN APPLICATION INVOLVING SERIOUS RISK TO LIFE OR PROPERTY OR IN LARGE QUANTITIES WITHOUT ENSURING THAT THE SYSTEM AS A WHOLE HAS BEEN DESIGNED TO ADDRESS THE RISKS, AND THAT THE OMRON'S PRODUCT IS PROPERLY RATED AND INSTALLED FOR THE INTENDED USE WITHIN THE OVERALL EQUIPMENT OR SYSTEM.
2. **Programmable Products.** Omron Companies shall not be responsible for the user's programming of a programmable Product, or any consequence thereof.
3. **Performance Data.** Data presented in Omron Company websites, catalogs and other materials is provided as a guide for the user in determining suitability and does not constitute a warranty. It may represent the result of Omron's test conditions, and the user must correlate it to actual application requirements. Actual performance is subject to the Omron's Warranty and Limitations of Liability.
4. **Change in Specifications.** Product specifications and accessories may be changed at any time based on improvements and other reasons. It is our practice to change part numbers when published ratings or features are changed, or when significant construction changes are made. However, some specifications of the Product may be changed without any notice. When in doubt, special part numbers may be assigned to fix or establish key specifications for your application. Please consult with your Omron's representative at any time to confirm actual specifications of purchased Product.
5. **Errors and Omissions.** Information presented by Omron Companies has been checked and is believed to be accurate; however, no responsibility is assumed for clerical, typographical or proofreading errors or omissions.

OMRON AUTOMATION AND SAFETY • THE AMERICAS HEADQUARTERS • Chicago, IL USA • 847.843.7900 • 800.556.6766 • www.omron247.com

OMRON CANADA, INC. • HEAD OFFICE

Toronto, ON, Canada • 416.286.6465 • 866.986.6766 • www.omron247.com

OMRON ELECTRONICS DE MEXICO • HEAD OFFICE

México DF • 52.55.59.01.43.00 • 01-800-226-6766 • mela@omron.com

OMRON ELECTRONICS DE MEXICO • SALES OFFICE

Apodaca, N.L. • 52.81.11.56.99.20 • 01-800-226-6766 • mela@omron.com

OMRON ELETRÔNICA DO BRASIL LTDA • HEAD OFFICE

São Paulo, SP, Brasil • 55.11.2101.6300 • www.omron.com.br

OMRON ARGENTINA • SALES OFFICE

Cono Sur • 54.11.4783.5300

OMRON CHILE • SALES OFFICE

Santiago • 56.9.9917.3920

OTHER OMRON LATIN AMERICA SALES

54.11.4783.5300

OMRON EUROPE B.V. • Wegalaan 67-69, NL-2132 JD, Hoofddorp, The Netherlands. • +31 (0) 23 568 13 00 • www.industrial.omron.eu

Authorized Distributor:

Automation Control Systems

- Machine Automation Controllers (MAC) • Programmable Controllers (PLC)
- Operator interfaces (HMI) • Distributed I/O • Software

Drives & Motion Controls

- Servo & AC Drives • Motion Controllers & Encoders

Temperature & Process Controllers

- Single and Multi-loop Controllers

Sensors & Vision

- Proximity Sensors • Photoelectric Sensors • Fiber-Optic Sensors
- Amplified Photomicrosensors • Measurement Sensors
- Ultrasonic Sensors • Vision Sensors

Industrial Components

- RFID/Code Readers • Relays • Pushbuttons & Indicators
- Limit and Basic Switches • Timers • Counters • Metering Devices
- Power Supplies

Safety

- Laser Scanners • Safety Mats • Edges and Bumpers • Programmable Safety Controllers • Light Curtains • Safety Relays • Safety Interlock Switches