



## EATS16 EATS16N

### Installation and user manual

Copyright © 2015 EATON  
All rights reserved.

**Service and support:**  
Call your local service representative

# SAFETY INSTRUCTIONS

**SAVE THESE INSTRUCTIONS.** This manual contains important instructions that should be followed during installation and maintenance of the ATS.

The EATON ATS models that are covered in this manual are intended for installation in an environment within **0°C to 40°C (32°F to 104°F)** and free of conductive contaminant.

## Certification standards

- Safety: IEC 62310-1
- EMC: IEC 62310-2
- Performance: IEC 62310-3
- CE Mark
- Additional conformances :
  - IEC 60950-1
  - CISPR 22 Class B

## Important safety notes

- Only qualified personnel can service this equipment.
- Follow the following precautions when working on this unit.
  - Remove watches, rings, or other metal objects.
  - Use tools with insulated handles.
- Examine the packing container. Notify the carrier immediately if any damage is present.
- Do not disassemble the unit.
- Do not operate the unit near water or in an area with excessive humidity.
- Keep liquid and foreign objects from getting inside the unit.
- Do not operate the unit close to gas or fire.
- Verify whether the branch circuit breaker or fuse on service feed is correct.
- Verify line voltage requirements and the supplied line voltage prior to installation.
- This unit is supplied from multiple sources, disconnect all sources before servicing.

## Electrical warnings

- Check that power cords, plugs, and outlets are in good condition.
- **RAL equipment:** "Equipment intended for installation in Restricted Access Location".

## Warning

- Intended to be connected to computer load.
- Not to be connected to inductive load or with >3:1 crest factor load.

<b>1. Introduction.....</b>	<b>4</b>
<b>2. Presentation.....</b>	<b>4</b>
2.1 Weights and dimensions .....	4
2.2 Rear panel layout - EATS16 - EATS16N .....	4
2.3 Control panel.....	4
2.4 LCD description .....	5
2.4.1 Power flow.....	5
2.4.2 Measures.....	6
2.5 ATS settings.....	6
2.6 Warning.....	8
<b>3. Installation for ATS .....</b>	<b>9</b>
3.1 Checking the accessory kit - EATS16 - EATS16N.....	9
3.2 Storage .....	10
3.3 Installation for rack mounting (normal installation) .....	10
3.4 Installation for rack mounting (2 post installation) .....	10
3.5 Wall installation.....	10
3.5 Instructions .....	11
<b>4. Power cables connection .....</b>	<b>12</b>
4.1 Installation diagram.....	12
4.2 Input/Output connection EATS16 - EATS16N.....	12
<b>5. Communication .....</b>	<b>13</b>
5.1 Communication ports: EATS16N .....	13
5.2 Eaton Intelligent Power Software suite .....	14
<b>6. Maintenance .....</b>	<b>15</b>
6.1 Troubleshooting .....	15
<b>7. Specifications .....</b>	<b>16</b>

# 1. Introduction

The EATON Automatic Transfer Switch (ATS) is a high availability switch designed for providing redundant power for sensitive equipment. It is powered by two independent power sources and automatically makes a rapid switch from one source to the other when the power supply used to power its connected load fails. This ATS is designed to be efficient and reliable.

Users can know EATON ATS's power flow, status, parameters from the LCD interface. Besides, the EATS16N unit has a network interface for users to read and write parameters. The network interface can be implemented via the Ethernet protocol through an RJ45 connector.

## 2. Presentation

### 2.1 Weights and dimensions

Rack installation

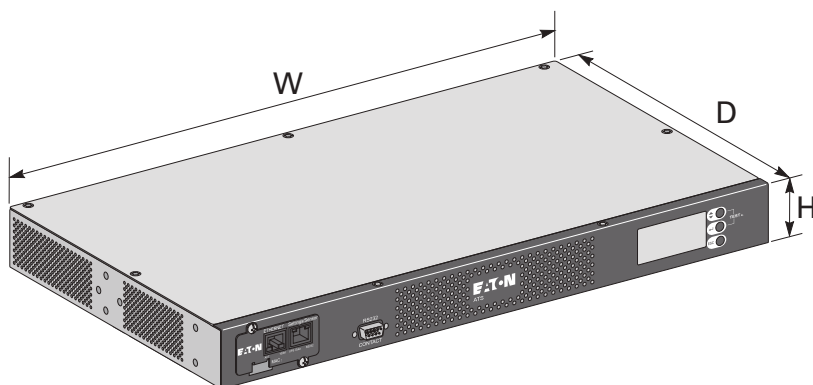

Description	Weights (kg / lb)	Dimensions H x W x D (mm / inch)
EATS16	3.32 / 7.31	43 x 438 x 250 / 1.7 x 17.24 x 9.84
EATS16N	3.54 / 7.8	43 x 438 x 250 / 1.7 x 17.24 x 9.84

### 2.2. Rear panel layout - EATS16 - EATS16N

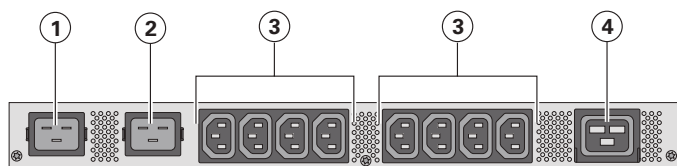

- ① Input Source 1: IEC C20 inlet
- ② Input Source 2: IEC C20 inlet
- ③ Output: 8 x C13 10 A
- ④ Output: 1 x C19 16 A

### 2.3 Control panel

The ATS has three buttons on the control panel and a LCD display. It provides useful information about the ATS itself, load status, events, measurements and settings.

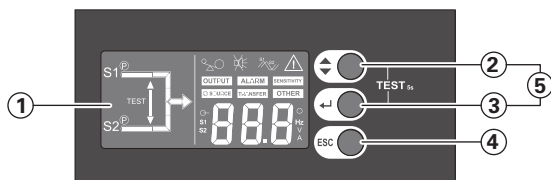

- ① LCD panel
- ② Navigation: Scroll down button
- ③ Navigation: Enter button
- ④ Navigation: Escape button
- ⑤ Transfer Test: Scroll down and Enter buttons pressed for 5s

2.4 LCD description

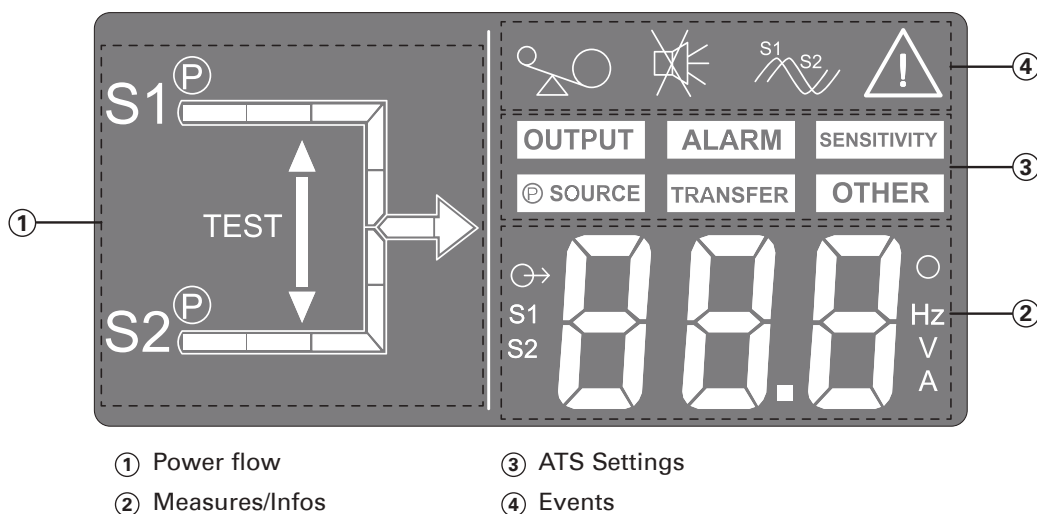





2.4.1 Power flow

	S1 is defined as the priority source (true by default) or S2 is defined as the priority source (can be set)
	S1 not powered or S2 not powered
	S1 powering the load or S2 powering the load
	S1 powered but not powering the load or S2 powered but not powering the load
	Transfer from S1 to S2 or Transfer from S2 to S1
	Transfer from S1 to S2 for Test or Transfer from S2 to S1 for Test

## 2. Presentation

### 2.4.2 Measures

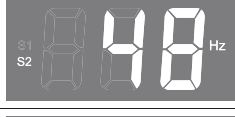
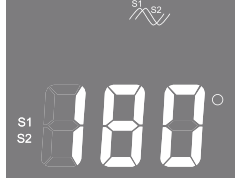
<b>Output current</b> (default display)	
<b>Output voltage</b>	
<b>Input voltage : S1</b> (default display only when S1 voltage is out of tolerance)	
<b>Input frequency: S1</b> (default display only when S1 frequency is out of tolerance)	
<b>Input voltage : S2</b> (default display only when S2 voltage is out of tolerance)	
<b>Input frequency: S2</b> (default display only when S2 frequency is out of tolerance)	
<b>S1 and S2 phase shift</b> (available only when S1 and S2 are not synchronized)	

## 2.5 ATS settings

<b>OUTPUT:</b> Sets voltage thresholds -	200 V - 208 V - 220 V - <b>230 V</b> (default) - 240 V
<b>ALARM:</b> Silents alarm -	<b>ON:</b> normal beep in warning or fault mode, by default <b>OFF:</b> silent.
<b>SENSITIVITY (mainly for LIA UPS):</b> Sets Sensitivity mode for input mains detection. -	<b>Std:</b> Normal Sensitivity, by default <b>Lo:</b> Low Sensitivity, for compatibility with distorted waveform.
<b>P SOURCE:</b> Sets the priority source	<b>Sc.1:</b> Priority on Source 1, by default <b>Sc.2:</b> Priority on Source 2
<b>TRANSFER:</b>	<b>Std:</b> no additional break even if S1 and S2 are not synchronized, by default <b>Gap:</b> additional break during transfer if S1 and S2 are not synchronized.



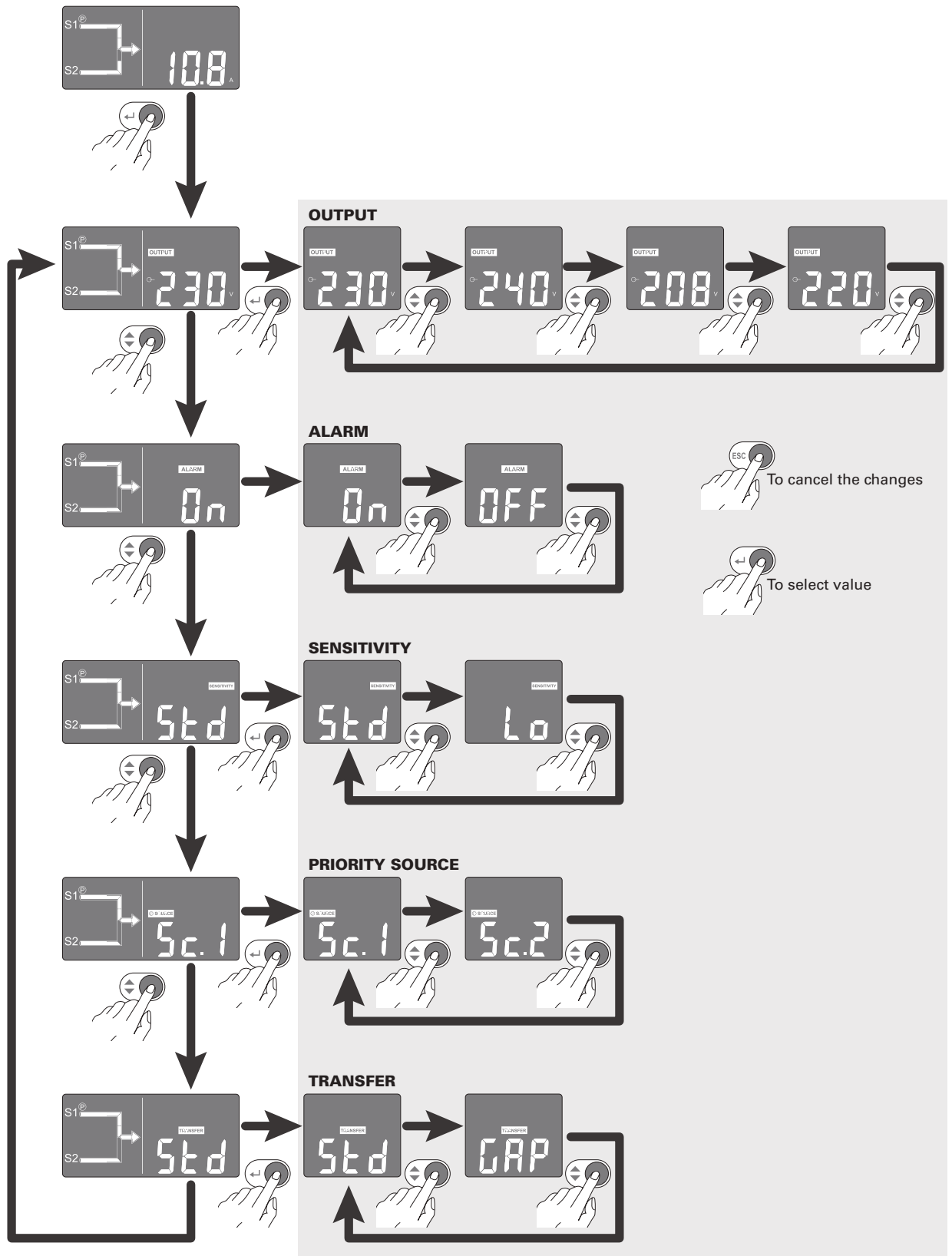

Press Enter to reach settings menu

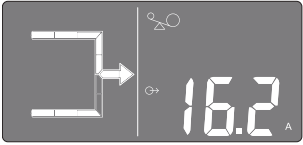

## 2. Presentation

### 2.6 Warning

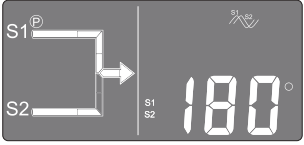
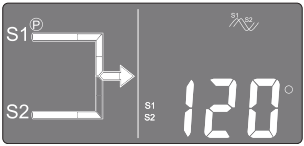
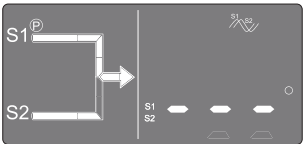
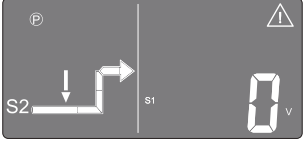
For Fault, refer to troubleshooting section 6.1.

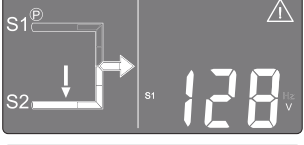
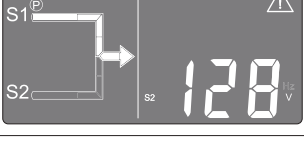
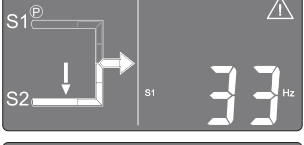
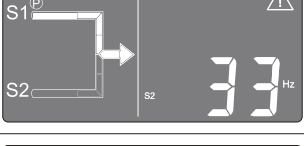
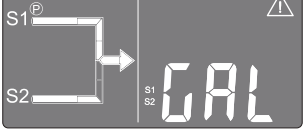
Event	Example of displays	Rootcause
Overload 		Load is over nominal rating Remove some of the equipment from the ATS. The ATS continues to operate, but may shutdown if the load increases. The alarm resets when the condition becomes inactive.
Unsynchronized sources 		One source N and L are reversed
		S1 and S2 are fed by different phase (L1/L2/L3)
		S1 and S2 frequency are different
Source 1 or Source 2 power loss		One of the source is missing, The ATS power on the load with the source that is present.
		
Source 1 or Source 2 voltage out of tolerance		One of the source voltage is out of tolerance. The display shows the voltage measure of the faulty source.
		
Source 1 or Source 2 frequency out of tolerance		One of the source frequency is out of tolerance. The display shows the frequency measure of the faulty source.
		
Source 1 and Source 2 quality		The sources are outside ranges so that it generates too many transfers within a short period of time. The alarm resets when the condition becomes inactive.



## 3. Installation for ATS

### 3.1 Checking the accessory kit - EATS16 - EATS16N

- Verify that the following additional items are included with the ATS:

#### EATS16

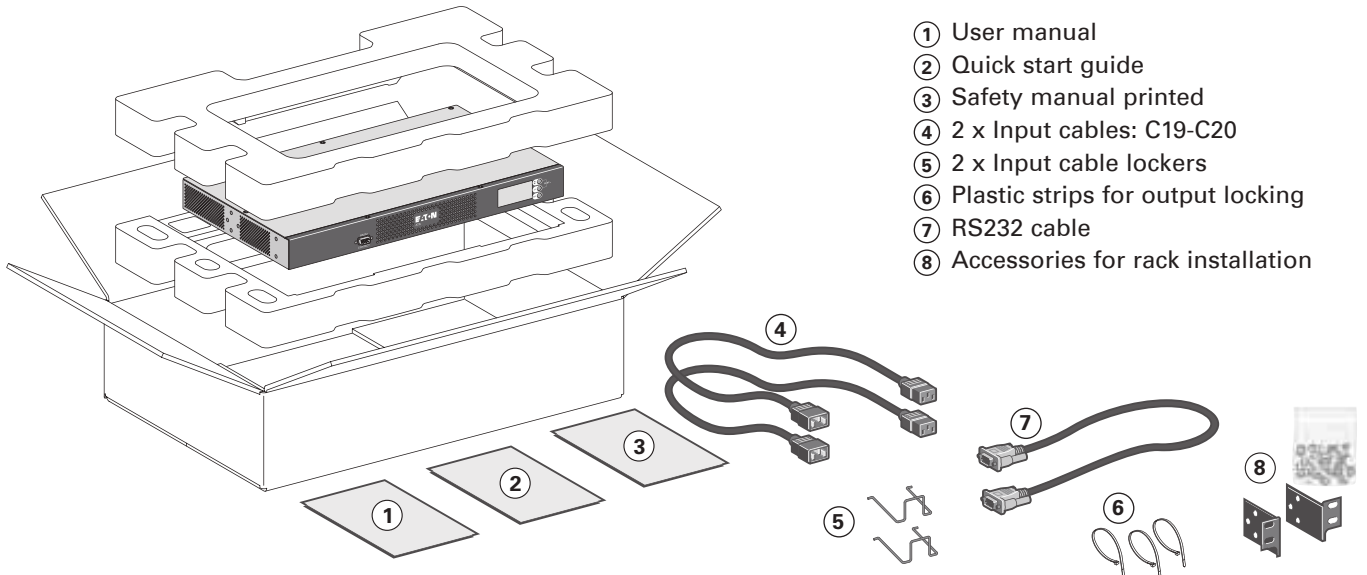

#### EATS16N

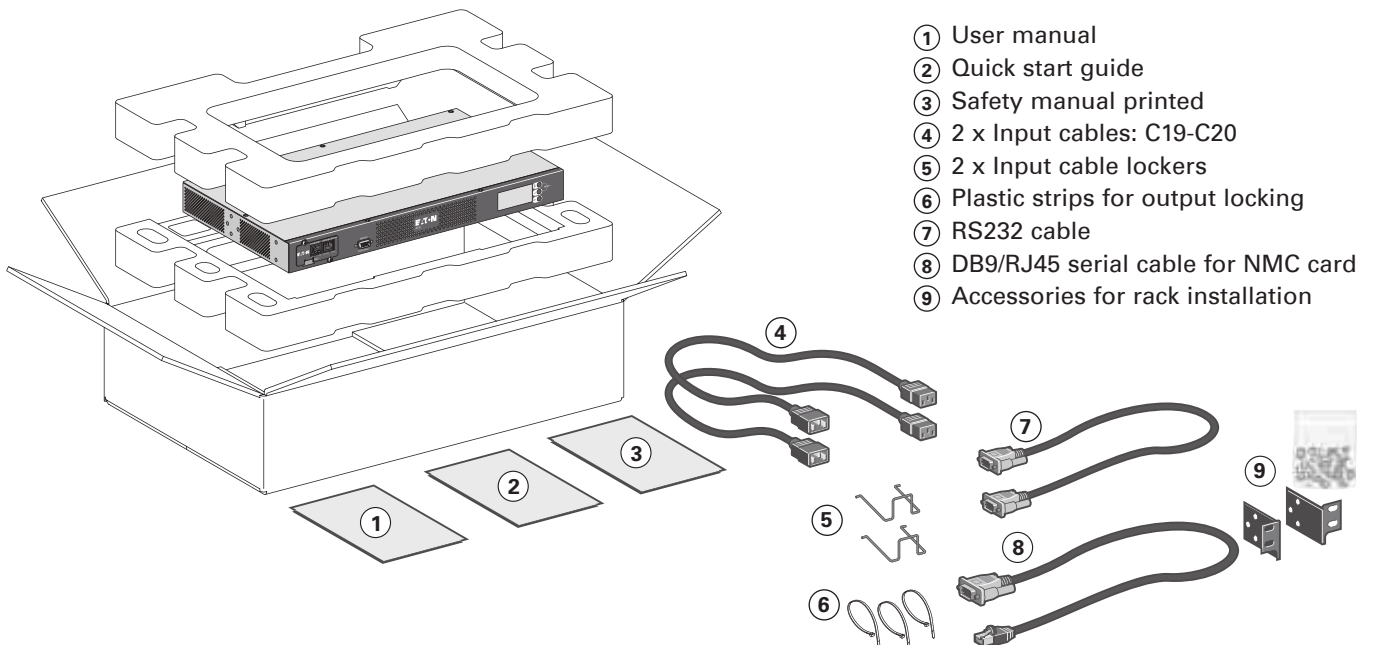

## 3. Installation for ATS

### 3.2 Storage

- Please store the ATS in its original package and in a dry place.  
Keep the storage temperature between -13 to 131°F (-25°C and +55°C).

### 3.3 Installation for rack mounting (normal installation)



Follow steps 1 to 3 for module mounting on the rails.

#### Accessories for rack installation

- 1 x Ear (Left)
- 1 x Ear (Right)
- 4 x M4 x 6 flat screw for ear
- 4 x M6 x 10 cage nut clip for rack
- 4 x M6 x 12 flat screw for rack
- 4 x M6 washer conical plate for rack

### 3.4 Installation for rack mounting (2 post installation)

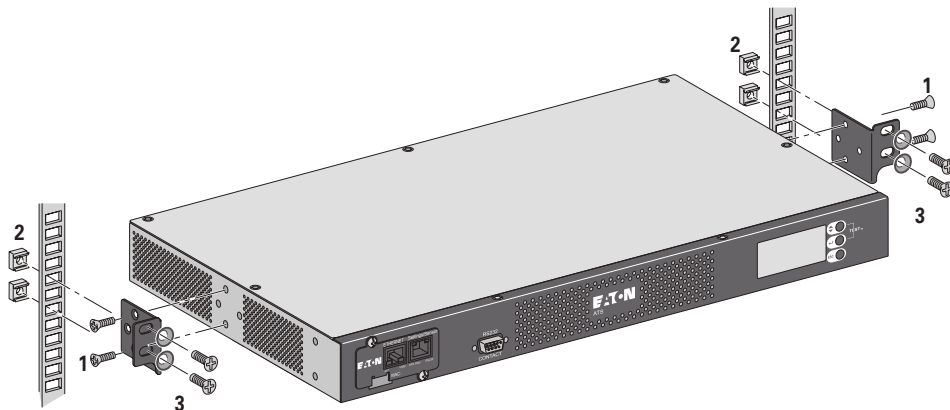

Follow steps 1 to 3 for module mounting on the rails.

#### Accessories for rack installation

- 1 x Ear (Left)
- 1 x Ear (Right)
- 4 x M4 x 6 flat screw for ear
- 4 x M6 x 10 cage nut clip for rack
- 4 x M6 x 12 flat screw for rack
- 4 x M6 washer conical plate for rack

### 3.5 Wall installation

Follow steps 1 to 2 for module mounting on the wall.



### 3.6 Instructions

1. Elevated Operating Ambient - If installed in a closed or multi-unit rack assembly, the operating ambient temperature of the rack environment may be greater than room ambient. Therefore, consideration should be given to installing the equipment in an environment compatible with the maximum ambient temperature (Tmax) specified by the manufacturer.
2. Reduced Air Flow - Installation of the equipment in a rack should be such that the amount of air flow required for safe operation of the equipment is not compromised.
3. Mechanical Loading - Mounting of the equipment in the rack should be such that a hazardous condition is not achieved due to uneven mechanical loading.
4. Circuit Overloading - Consideration should be given to the connection of the equipment to the supply circuit and the effect that overloading of the circuits might have on overcurrent protection and supply wiring. Appropriate consideration of equipment nameplate ratings should be used when addressing this concern.
5. Reliable Earthing - Reliable grounding of rack-mounted equipment should be maintained. Particular attention should be given to supply connections other than direct connections to the branch circuit (e.g. use of power strips).

## 4. Power cables connection

### 4.1 Installation diagram

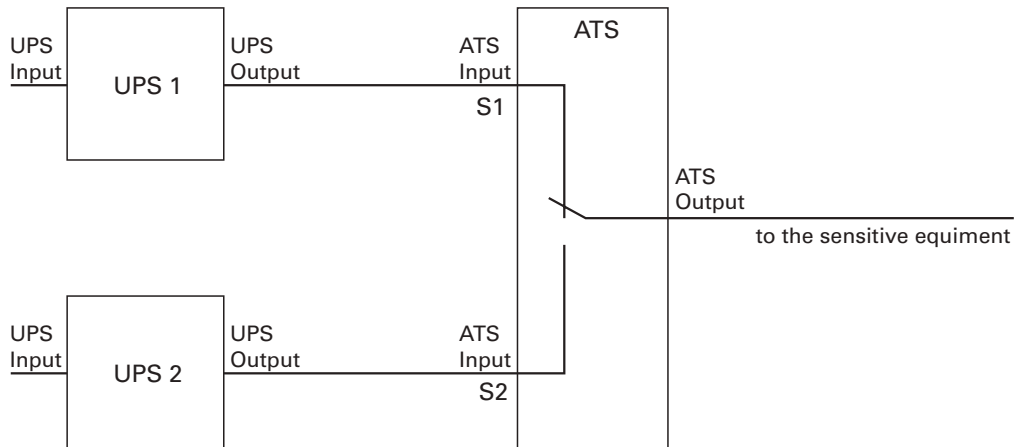

### 4.2 Input/Output connection EATS16 - EATS16N

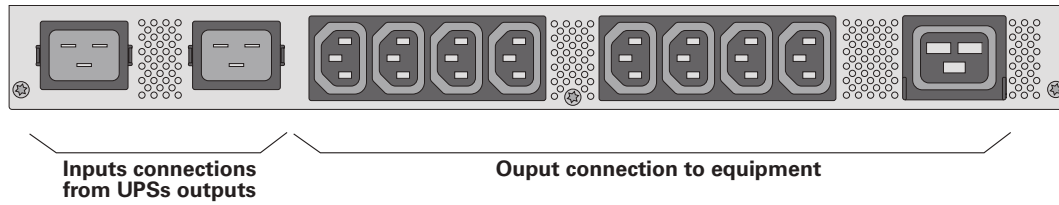

1. Connect input power cables to UPSs output and to ATS inputs (S1 is the default priority source).
2. Connect ATS output to the equipment.

# 5. Communication

## 5.1 Communication ports: EATS16N

- RS232 communication port

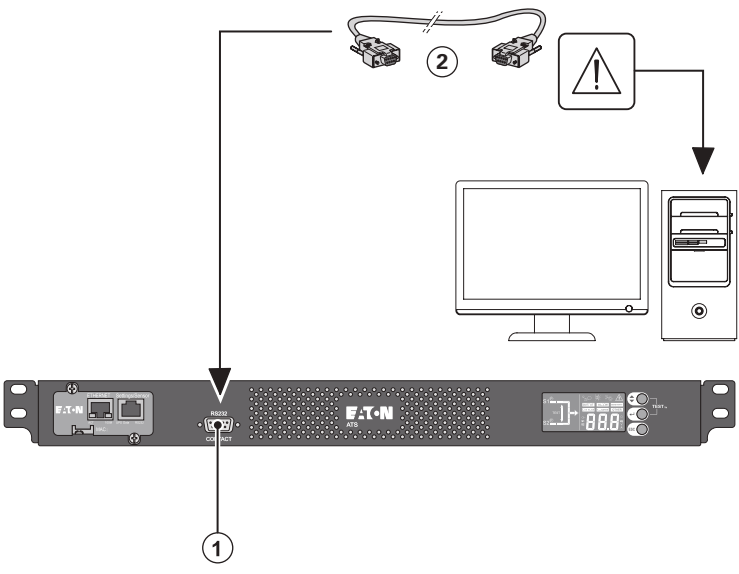

1. Connect the RS232 ② communication cable to the serial on the computer.
2. Connect the other end of the communication cable ② to the RS232 ① communication port on the ATS.

The **ATS** can now communicate with EATON power management software.

- Characteristics of the optocouplers communication port

When a signal is activated, the contact is closed between the common (Pin 4) and the pin of the corresponding signal for n.o contact, and vice versa for n.c contact.

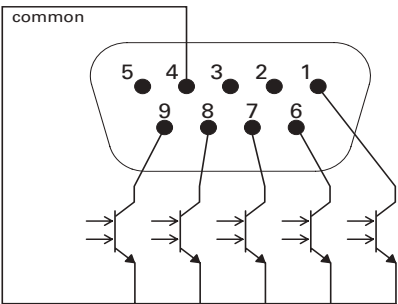

- Contact characteristics (optocoupler)**
- Voltage: 48 V DC max
  - Current: 25 mA max
  - Power: 1.2 W

Pin assignment	Description	Contact type	Open State	Close State
Pin 1	Summary alarm signal	n.o	Normal	Alarm occurred
Pin 2	RX	-	-	-
Pin 3	TX	-	-	-
Pin 4	Common	-	-	-
Pin 5	GND	-	-	-
Pin 6	Source 1 OK	n.c	Source 1 is failure	Source 1 is ok
Pin 7	Source 2 OK	n.c	Source 2 is failure	Source 2 is ok
Pin 8	Load on source 1	n.c	Source 1 not take load	Source 1 takes load
Pin 9	Load on source 2	n.c	Source 2 not take load	Source 2 takes load

n.o: normally opened  
n.c: normally closed

## 5. Communication

- **Connectivity Cards: EATS16N**

Connectivity cards allow the ATS to communicate in a variety of networking environments and with different types of devices. The **Network-MS card** has SNMP and HTTP capabilities as well as monitoring through a Web browser interface; connects to Ethernet network. In addition, an Environmental Monitoring Probe can be attached to obtain humidity, temperature, smoke alarm, and security information.

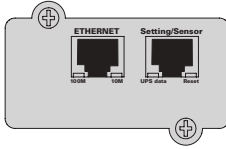

Network-MS card

### 5.2 Eaton Intelligent Power Software suite

Eaton Software suite provides up-to-date graphics of ATS power and system data and power flow. It also gives you a complete record of critical power events, and it notifies you of important ATS or power information.

6.1 Troubleshooting

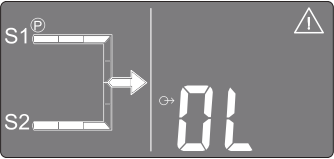
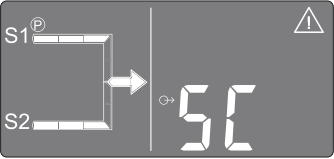
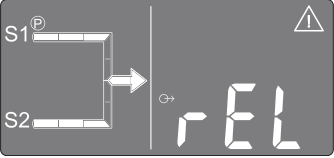
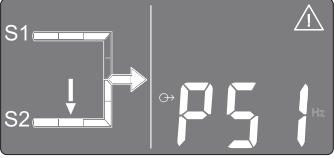
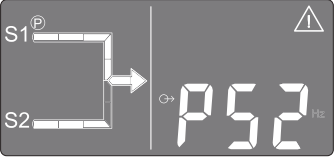
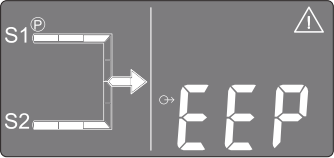
Operation status	Possible cause	Action
<p>Overload</p> 	<p>Power requirement exceeds the ATS capacity (greater than 105 % of nominal).</p>	<p>Remove some of the equipment from the ATS. The ATS continues to operate, but may shutdown if the load increases. The alarm resets when the condition becomes inactive.</p>
<p>Short-circuit fault</p> 	<p>A short-circuit occurred.</p>	<p>Check device connection or integrity.</p> <p>If error persists, note the alarm message and the ATS serial number, and then contact your service representative.</p>
<p>Internal relay fault</p> 	<p>Internal relay fault, note that the load is no powered.</p>	<p>Note the alarm message and the ATS serial number, and then contact your service representative.</p>
<p>Source 1 or Source 2 power supply fault</p>  	<p>Internal power supply of one of the source is faulty; the other source is powering the load.</p>	<p>Note the alarm message and the ATS serial number, and then contact your service representative.</p>
<p>EEPROM fault</p> 	<p>EEPROM fault, note that the load is still powered.</p>	<p>Note the alarm message and the ATS serial number, and then contact your service representative.</p>

## 7. Specifications

**Table 1. Model list**

Model	Operating voltage	Current rating	Operating frequency
EATS16	200/208/220/230/240 Vac 1 $\phi$	16A	50/60 Hz
EATS16N			

**Table 2. Weights and dimensions**

Model	Dimensions H x W x D (mm/inch)	Weight (kg/lb)
EATS16	43 x 438 x 250 / 1.7 x 17.24 x 9.84	3.32 / 7.31
EATS16N	43 x 438 x 250 / 1.7 x 17.24 x 9.84	3.54 / 7.8

**Table 3. Electrical input connections**

Model	Input connection
EATS16 - EATS16N	IEC C20 inlet (2 x Input cables: C19-C20 provided)

**Table 4. Electrical output connections**

Model	Output connection
EATS16 - EATS16N	1 x C19 8 x C13

**Table 5. Environmental and safety**

<b>Operating temperature</b>	0°C to 40°C (32°F to 104°F)
<b>Storage temperature</b>	-25°C to 55°C / -13°F to 131°F
<b>Relative humidity</b>	Storage: 0-90% Operating: 20-85%
<b>Operating altitude</b>	2000m meters (6252 ft)
<b>Audible noise</b>	25 dBA max (without buzzer)