

Manual Motor Starters

Standard type

- Adjustable thermal release
- Magnetic release 13 I_e max.
- Trip class 10
- Protective function
 - phase-failure
 - short circuit
 - overload





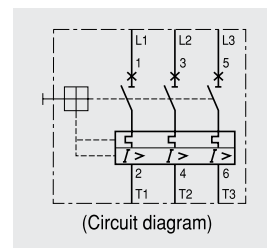



MMS-32S

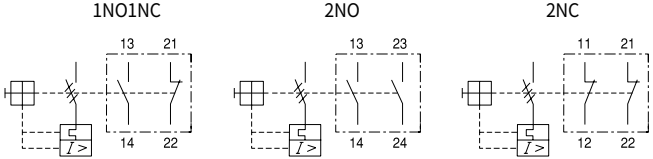

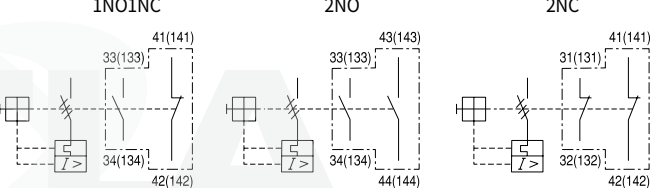
Type	Rated operational current I _e [A]	Thermal release Adjustment range [A]	Magnetic release Operating current [A]	Switching of 3 phase AC motors, AC-2, AC-3						400/415V	
				3-phase [kW] (50/60Hz)			3-phase [HP] (60Hz)			I _{cu} [kA]	I _{cs} [kA]
				230V	400V	690V	230V	460V	575V		
MMS-32S	0.16	0.1...0.16	2.1	-	0.02	-	-	-	-	100	100
	0.25	0.16...0.25	3.3	0.03	0.06	-	-	-	-	100	100
	0.4	0.25...0.4	5.2	0.06	0.09	-	-	-	-	100	100
	0.63	0.4...0.63	8.2	0.09	0.12	0.25	-	-	-	100	100
	1	0.63...1.0	13	0.12	0.25	0.55	-	1/2	1/2	100	100
	1.6	1.0...1.6	20.8	0.25	0.55	1.1	1/3	3/4	1	100	100
	2.5	1.6...2.5	32.5	0.37	0.75	1.5	1/2	1½	1½	100	100
	4	2.5...4.0	52	0.75	1.5	3	1	2	3	100	100
	6	4...6	78	1.5	2.2	4	1½	5	5	100	100
	8	5...8	104	1.5	3	5.5	2	5	5	100	100
	10	6...10	130	3	4	7.5	3	7½	10	50	38
	13	9...13	169	3	5.5	11	3	7½	10	50	38
	17	11...17	221	4	7.5	11	5	10	15	20	15
	22	14...22	286	4	7.5	15	7½	15	20	15	11
	26	18...26	338	5.5	11	18.5	7½	15	20	15	11
	32	22...32	416	7.5	15	22	10	20	30	10	5
40	28~40	520	7.5	18.5	30	15	30	40	10	5	



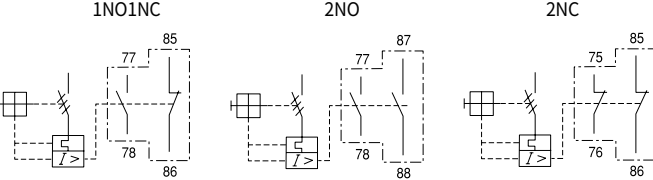

Accessories (Electrical Auxiliaries)

Type	Description	Connection diagram
<p>FX...</p> 	<p>Auxiliary Switch</p> <ul style="list-style-type: none"> • Front mounting • 2-pole • One front mounting module per circuit breaker 	
<p>LX...</p> 	<p>Auxiliary Switch</p> <ul style="list-style-type: none"> • Side mounting on the left • 2-pole • One side mounting module per circuit breaker 	
<p>LA...</p> 	<p>Any Trip Alarm Switch</p> <ul style="list-style-type: none"> • Operates in case of trip • Side mounting on the left • 2-pole • Set LA first in case of using LX together (MMS-63 can not accept LX and LA together) • For MMS-32 and MMS-63/100 products are separated. 	
<p>LAM...</p> 	<p>Magnetic Trip Alarm Switch</p> <ul style="list-style-type: none"> • Operates in case of short circuit accidents that is over 20 times of the rated current • Side mounting on the left • 2-pole • Set LAM first in case of using LX together 	

Manual Motor Starters

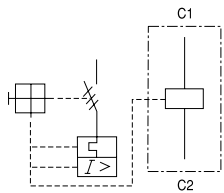
Product Selection Guide

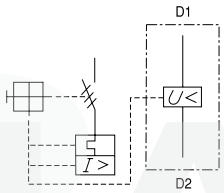
Accessories (Electrical Auxiliaries)

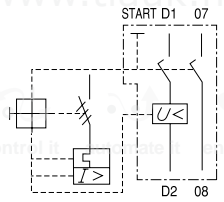
Type	Description	Connection diagram	
RS... 	Shunt release <ul style="list-style-type: none"> Side mounting on the right One side mounting module per circuit breaker. Can not use with RU or RUX 		24V 50Hz / 28V 60Hz 110V 50Hz / 120V 60Hz 200V 50Hz / 200~220V 60Hz 220~230V 50Hz / 240~260V 60Hz 240V 50Hz / 277V 60Hz 380~400V 50Hz / 440~460V 60Hz 415~440V 50Hz / 460~480V 60Hz
RU... 	Undervoltage release <ul style="list-style-type: none"> Side mounting on the right One side mounting module per circuit breaker. Can not use with RU or RUX 		24V 50Hz / 28V 60Hz 110V 50Hz / 120V 60Hz 200V 50Hz / 200~220V 60Hz 220~230V 50Hz / 240~260V 60Hz 240V 50Hz / 277V 60Hz 380~400V 50Hz / 440~460V 60Hz 415~440V 50Hz / 460~480V 60Hz
RUX... 	Undervoltage release with Switch <ul style="list-style-type: none"> Side mounting on the right Include 2NO Auxiliary contact One side mounting module per circuit breaker. Can not use with RU or RUX Can not attach to MMS-32S 		24V 50Hz / 28V 60Hz 110V 50Hz / 120V 60Hz 200V 50Hz / 200~220V 60Hz 220~230V 50Hz / 240~260V 60Hz 240V 50Hz / 277V 60Hz 380~400V 50Hz / 440~460V 60Hz 415~440V 50Hz / 460~480V 60Hz



● Phase Bus System

It is a device for a parallel connection with power terminals in the circuit lined up by MMS, and it can provide the solution “Simple wiring” and “Compact wiring space”.

- Application Model : MMS-32, 63
- CE and UL certified
- Safety Cover built-in
- RoHS compliance

Type	Application MMS	Number of Terminals	Rated current	Safety cover attached
PB-322	MMS-32S, 32H, 32HI	2	63A	PBPC-32
PBL-322	MMS-32S, 32H, 32HI with Aux (LX or LA or LAM)	2		
PB-323	MMS-32S, 32H, 32HI	3		
PBL-323	MMS-32S, 32H, 32HI with Aux (LX or LA or LAM)	3		
PB-324	MMS-32S, 32H, 32HI	4		
PB-325	MMS-32S, 32H, 32HI	5	108A	PBPC-63
PB-632	MMS-63S, 63H, 63HI	2		
PB-633	MMS-63S, 63H, 63HI	3		

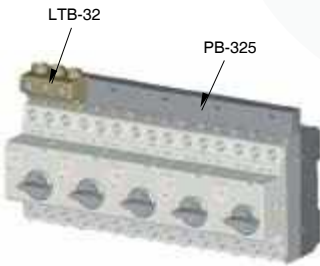

Model	LTB-32
Pole	3P
Mounting location	Upstream
IP degree of protection	IP20 according to IEC 60529
Rated insulation voltage (Ui)	690V according to IEC 60947-1
Rated operational current (Ie)	63A
Terminal torque	1.7 N.m- on screw clamp terminals

● Diagram

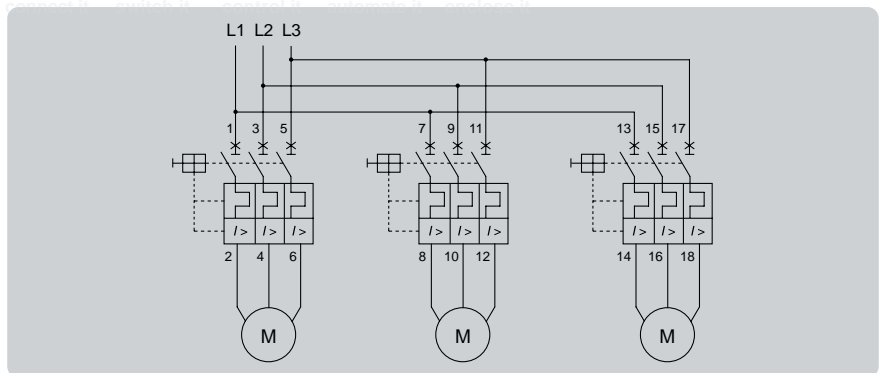

● Terminal Block (TB-32)

It is an accessory device for ensuring the insulation distance between phases. When this device is used, it meets the requirements of UL Combination Motor Controller Type E.

- Application Model : MMS-32H, HI

dItem code	Descriptionddd	Remark
62671941002	TERMINAL ASS'Y,LUG,TB-32	For Type-E self-protected motor controller

Manual Motor Starters

Technical Information

General data

• Terminals

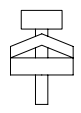
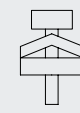
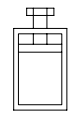
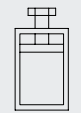
Contents		MMS32S	MMS32H	MMS63S, 63H	MMS100S, 100H
Conformity to standards		IEC60947 UL508, UL508 Type E			
Approvals		CE, UL			
Terminal parts					
Wire					
Single-core	1 conductor	[mm ²] / [AWG]	1...10 / 18...8	0.75...35 / 18...2	2.5...70 / 12...2/0
	2 conductor	[mm ²] / [AWG]	1...6 / 18...10	0.75...25 / 18...4	2.5...50 / 12...1/0
Stranded	1 conductor	[mm ²] / [AWG]	1...6 / 18...10	0.75...35 / 18...2	2.5...70 / 12...2/0
	2 conductor	[mm ²] / [AWG]	1...6 / 18...10	0.75...25 / 18...4	2.5...50 / 12...1/0
Flexible	1 conductor	[mm ²] / [AWG]	1...6 / 18...10	0.75...25 / 18...4	2.5...50 / 12...1/0
	2 conductor	[mm ²] / [AWG]	0.75...4 / 18...10	0.75...16 / 18...6	2.5...35 / 10...2
Tightening torque		[Nm] / [lb-in]	0.8...2.5 / 7...22	3...4.5 / 26...39	4...6 / 35...53

• Power consumption

Contents		MMS32S	MMS32H	MMS63S, 63H	MMS100S, 100H
Total power loss P _v					
Circuit breaker at rated load operating temperature	[W]	In = 0.16~1.6A : 4.4	In = 0.16~1.6A : 4.4	In = 10~22A : 10.2	In = 17~32A : 15
		In = 2.5~26A : 7.4	In = 2.5~26A : 7.4	In = 26~63A : 9.7	In = 40~63A : 21.8
		In = 32A : 4.0	In = 32A : 4.0		In = 75~100A : 17.8

• Mounting

- 35mm DIN rail for MMS32~63
- 35mm or 75mm DIN rail for MMS100
- use 15mm depth for 35mm DIN rail

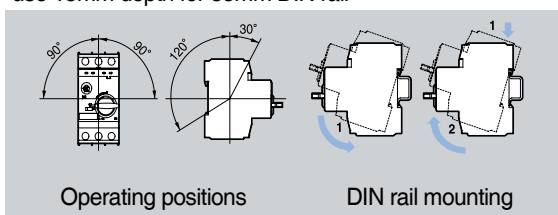

• Caution for thermal adjustments

1. Keep the setting range as shown below.
2. Moving counterclockwise out of the setting range may cause the damage of the device.

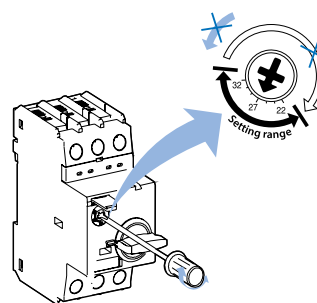

Dial setting method

3. Calibration by ambient air temperature

A : set to one point lower	Calibrated automatically	B : set to one point higher
-20°C	-5°C	+40°C
		+60°C

In case of using out of the standard air temperature range(-5°C~+40°C) it needs to be calibrated by one point

● Auxiliaries

Contents		Auxiliary contacts for front mounting FX...		Auxiliary contacts for left side mounting LX...		Alarm switch for left side mounting LA...		
Rated thermal current / th								
at 40°C ambient temperature	[A]	5		10		10		
at 60°C ambient temperature	[A]	3		6		6		
Contact class coordination according to NEMA (UL/CSA-Standards)		AC	A600	A600		A600		
		DC	Q300	Q300		Q300		
Back-up fuses gG, gL		[A]	16		16		16	
Rated supply current		[V]	-	240	24	240	24	240
AC-15:	[A]	-	3		6	4	6	4
DC-13:	[V]	24	220		24	220	24	220
	[A]	1	0.1		2	0.25	2	0.25
Weight (g)		18		30		40		
Terminal parts								
Wire						 Pozidriv size 2		
Single-core	1 conductor	[mm²] / [AWG]	0.5...2.5 / 20...14		0.5...2.5 / 20...14		0.5...2.5 / 20...14	
	2 conductor	[mm²] / [AWG]	-		-		-	
Stranded	1 conductor	[mm²] / [AWG]	0.5...4 / 20...10		0.5...4 / 20...10		0.5...4 / 20...10	
	2 conductor	[mm²] / [AWG]	0.75...2.5 / 18...14		0.75...2.5 / 18...14		0.75...2.5 / 18...14	
Tightening torque		[Nm] / [lb-in]	0.8...1.2 / 7...10		0.8...1.2 / 7...10		0.8...1.2 / 7...10	

www.tlauk.net

Contents		Undervoltage release for right side mounting RU...		Undervoltage release with 2 auxiliary contacts for right side mounting RUX...		Shunt release for right side mounting RS...		
Actuating voltage								
Pull-in		0.7...1.1×Us		0.85...1.1×Us		0.85...1.1×Us		
Drop-out				0.7...0.35×Us		0.7...0.35×Us		
Rated control voltage								
min.:		24V 50Hz / 28V 60Hz		24V 50Hz / 28V 60Hz		24V 50Hz / 28V 60Hz		
max.:		415~440V 50Hz / 460~480V 60Hz		415~440V 50Hz / 460~480V 60Hz		415~440V 50Hz / 460~480V 60Hz		
Coil rating								
Pull-in		8.5VA, 6W		8.5VA, 6W		8.5VA, 6W		
Hold		3VA, 1.2W		3VA, 1.2W		3VA, 1.2W		
Opening time (ms)		-		20		20		
Weight (g)		18		30		40		
Terminal parts								
Wire						 Pozidriv size 2		
Single-core	1 conductor	[mm²] / [AWG]	0.5...2.5 / 20...14		0.5...2.5 / 20...14		0.5...2.5 / 20...14	
	2 conductor	[mm²] / [AWG]	-		-		-	
Stranded	1 conductor	[mm²] / [AWG]	0.5...4 / 20...10		0.5...4 / 20...10		0.5...4 / 20...10	
	2 conductor	[mm²] / [AWG]	0.75...2.5 / 18...14		0.75...2.5 / 18...14		0.75...2.5 / 18...14	
Tightening torque		[Nm] / [lb-in]	0.8...1.2 / 7...10		0.8...1.2 / 7...10		0.8...1.2 / 7...10	

Manual Motor Starters

Technical Information

General data

• Installation of auxiliaries

Be sure to turn off the main switch of MMS before any other action.



MMS-32S/H/Hi

- To install FX remove the cover ① first.
- 2 each of LX can be installed together.
- Only one of auxiliaries among RU, RS and RUX can be mounted on the right side of MMS.
- Do not give trip signal to RS longer than 10 sec.
- Refer to the possible combination chart for the mounting of LX, LA and LAM on left side of MMS.

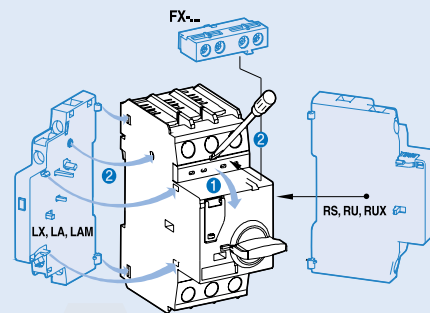

- Push the trip button before installation of LAM

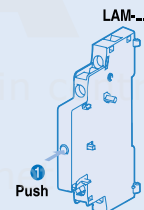

- Remove the indicated part in the fig. before the additional installation of LX

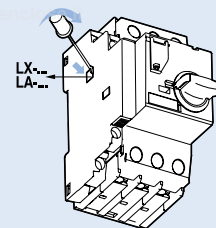

Separation of auxiliaries from MMS

- be sure to turn off the main switch of MMS before the separation.
- push softly the separation button on the side of the auxiliary and pull it.

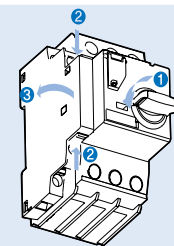

※Please make sure to choose proper LA before use because LA for MMS-32 and MMS-63/100 is different.

Manual Motor Starters

Technical Information

General data

● Installation of auxiliaries

How to Install and reset RUX

Installing

- (1) Check if the trip button of RUX is "UP".
If not, push the side lever ① to come it up.
- (2) Fit the both lower hooks ② into the MMS.
- (3) Rotate the handle of MMS to the 20 to 30 degree ③ to ON direction and keep it.
- (4) Fit the both upper hooks ④ into the MMS.
- (5) Input power to the RUX.
- (6) Turn ON the handle of MMS.

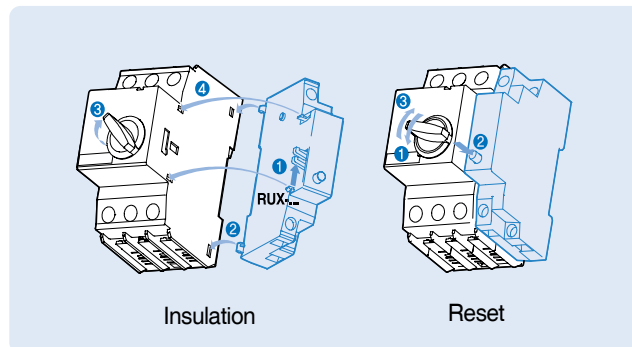

Resetting

The trip button of RUX does not come "UP" in the event of tripping due to undervoltage.

To turn ON the MMS after the tripping

- ① turn OFF the MMS and check if the trip button of RUX comes "UP".
- ② push the trip button
- ③ turn ON the MMS

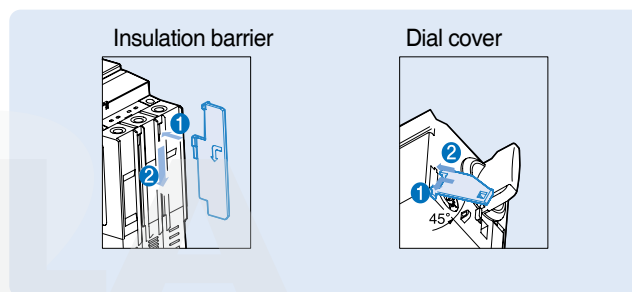

* Only for MMS-100

* For all MMS

Combination with mini contactors

Adaptor	MMS	+ Contactor model
DA-16SA	MMS-32S	+ GMC-6M-16M
DA-16SD	MMS-32S	+ GMD-6M-16M
DA-16HA	MMS-32H, 32HI	+ GMC-6M-16M
DA-16HD	MMS-32H, 32HI	+ GMD-6M-16M
DA-18SA	MMS-32S	+ MC-6a-18a
DA-18SD	MMS-32S	+ MC-6a-18a DC
DA-18HA	MMS-32H	+ MC-6a-18a
DA-18HD	MMS-32H	+ MC-6a-18a DC
DA-22SA	MMS-32S	+ MC-9b-22b
DA-22SD	MMS-32S	+ MC-9b-22b DC
DA-22HA	MMS-32H, 32HI	+ MC-9b-22b
DA-22HD	MMS-32H, 32HI	+ MC-9b-22b DC
DA-32SA	MMS-32S	+ MC-9-32(32a, 40a)
DA-32SD	MMS-32S	+ MC-9-32(32a, 40a) DC
DA-32HA	MMS-32H, 32HI	+ MC-9-32(32a, 40a)
DA-32HD	MMS-32H, 32HI	+ MC-9-32(32a, 40a) DC
DA-63A	MMS-63S, 63H, 63HI	+ MC-35-63(50a, 65a) / Lug Type Only
DA-63D	MMS-63S, 63H, 63HI	+ MC-35-63(50a, 65a) DC / Lug Type Only
DA-95A	MMS-100S, 100H, 100HI	+ MC-65-95(75a, 85a, 100a) / Lug Type Only
DA-95D	MMS-100S, 100H, 100HI	+ MC-65-95(75a, 85a, 100a) DC / Lug Type Only

everything in control

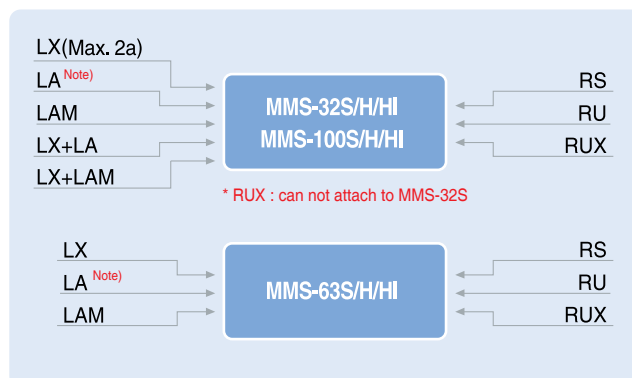
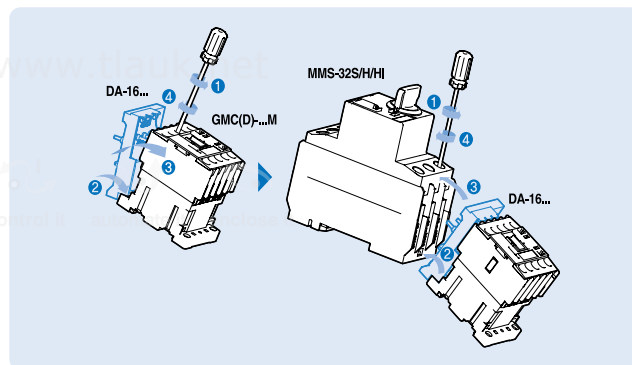

(Note) LA(32 on 63/100 is a sparate).

Possible combination chart

Please read this chart completely before installing the auxiliaries.

Improper combination can cause electric failure or accident.

IEC performance data (Motor protection)

Standard type

• MMS 32S

Rated operational current I_e		0.16	0.25	0.4	0.63	1	1.6	2.5	4	6	8	10	13	17	22	26	32	40	
Switching of standard three-phase motors																			
AC-2, AC-3																			
230/240V	[kW]	-	0.03	0.06	0.09	0.12	0.18/0.25	0.37	0.55/0.75	1.1/1.5	1.5	2.2/3	3	3.7/4	4	5.5	7.5	7.5	
400/415V	[kW]	0.02	0.06	0.09	0.12	0.18/0.25	0.37/0.55	0.75	1.1/1.5	2.2	3	3.7/4	5.5	7.5	7.5	11	15	18.5	
500V	[kW]	-	-	-	0.25	0.37	0.55/0.75	1.1	1.5/2.2	3	3.7	4/5.5	7.5	11	11	15	18.5	22	
690V	[kW]	-	-	-	0.25	0.37/0.55	0.75/1.1	1.5	2.2/3	3.7/4	5.5	7.5	11	11	15	18.5	22	30	
Back-up fuses																			
gG, gL, only if $I_{cc} > I_{cu}$																			
(* = No back up fuse required)																			
230/240V	[kA]	*	*	*	*	*	*	*	*	*	*	*	*	*	125	125	125	160	
400/415V	[kA]	*	*	*	*	*	*	*	*	*	*	80	80	100	100	100	100	125	
440/460V	[kA]	*	*	*	*	*	*	50	50	63	63	80	80	100	100	100	100	100	
500V	[kA]	*	*	*	*	*	*	50	40	50	63	63	80	80	80	80	80	80	
690V	[kA]	*	*	*	*	*	20	35	40	50	63	63	63	63	63	63	63	63	
Ultimate short-circuit breaking capacity I_{cu}																			
230/240V	[kA]	100	100	100	100	100	100	100	100	100	100	100	100	50	40	40	30	20	
400/415V	[kA]	100	100	100	100	100	100	100	100	100	100	50	50	20	15	15	15	10	
440/460V	[kA]	100	100	100	100	100	100	100	50	15	15	15	10	10	8	8	6	5	
500V	[kA]	100	100	100	100	100	100	50	15	10	10	6	6	6	6	6	5	4	
690V	[kA]	100	100	100	100	100	3	3	3	3	3	3	3	3	3	3	3	2	
Rated service short-circuit breaking capacity I_{cs}																			
230/240V	[kA]	100	100	100	100	100	100	100	100	100	100	100	38	30	30	22	15		
400/415V	[kA]	100	100	100	100	100	100	100	100	100	100	38	38	15	11	11	11	8	
440/460V	[kA]	100	100	100	100	100	100	38	11	11	11	8	8	6	6	4	3		
500V	[kA]	100	100	100	100	100	100	38	11	8	8	5	5	5	5	4	3		
690V	[kA]	100	100	100	100	100	3	3	3	3	3	3	3	3	3	3	3	2	

www.tlauk.net



connect it switch it control it automate it enclose it

Manual Motor Controller (UL508)

• MMS 32S

Rated operational current I _e		0.16	0.25	0.4	0.63	1	1.6	2.5	4	6	8	10	13	17	22	26	32	40	
Max. short-circuit current																			
240V	[kA]	100	100	100	100	100	100	100	100	100	100	50	50	40	30	30	20	20	
480V	[kA]	50	50	50	50	50	50	50	50	25	25	10	10	10	10	7.5	7.5	7.5	
600V	[kA]	10	10	10	10	10	10	10	5	5	5	5	5	5	5	5	5	5	
Motor load																			
1 Phase	115V	[HP]	-	-	-	-	-	-	1/8	1/4	1/3	1/2	1/2	1	1½	2	2	3	
	230V	[HP]	-	-	-	-	1/10	1/6	1/3	1/2	1	1½	2	3	3	3	5	7½	
3 Phase	200V	[HP]	-	-	-	-	-	1/2	3/4	1	2	2	3	3	5	7½	7½	10	
	230V	[HP]	-	-	-	-	-	1/2	3/4	1½	2	3	3	5	7½	7½	10	10	
	460V	[HP]	-	-	-	-	3/4	1	2	3	5	5	7½	10	15	15	20	30	
	575V	[HP]	-	-	-	-	1/2	3/4	1½	3	5	5	7½	10	15	20	30	30	
Max. fuse size		[A]	1	1	1	1	3	6	10	15	20	30	40	50	60	80	100	125	150
Max. breaker size		[A]	15	15	15	15	15	15	15	20	30	40	50	60	80	100	125	150	

In case of 1-phase use
in series as shown below

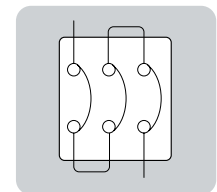

connect it switch it control it automate it enclose it

Manual motor controller (UL 508, CSA C22.2 as Manual motor controllers)

Combination Motor Controller

- Group Installation
- Type E starter

• MMS 32S

Rated operational current I _e			0.16	0.25	0.4	0.63	1	1.6	2.5	4	6	8	10	13	17	22	26	32	40	
Max. short-circuit current																				
240V	[kA]		100	100	100	100	100	100	100	100	100	100	50	50	40	30	30	20	20	
480V	[kA]		50	50	50	50	50	50	50	50	25	25	10	10	10	10	7.5	7.5	7.5	
600V	[kA]		10	10	10	10	10	10	10	5	5	5	5	5	5	5	5	5	5	
Motor load																				
1 Phase	115V	[HP]	-	-	-	-	-	-	-	1/8	1/4	1/3	1/2	1/2	1	1½	2	2	3	
	230V	[HP]	-	-	-	-	-	1/10	1/6	1/3	1/2	1	1½	2	3	3	3	5	7½	7½
3 Phase	200V	[HP]	-	-	-	-	-	-	1/2	3/4	1	2	2	3	3	5	7½	7½	10	10
	230V	[HP]	-	-	-	-	-	-	1/2	3/4	1½	2	3	3	5	7½	7½	10	10	10
	460V	[HP]	-	-	-	-	-	3/4	1	2	3	5	5	7½	10	15	15	20	30	30
	575V	[HP]	-	-	-	-	1/2	3/4	1½	3	5	5	7½	10	15	20	20	30	30	30
Max. fuse size		[A]	1	1	1	1	3	6	10	15	20	30	40	50	60	80	100	125	125	
Max. breaker size		[A]	15	15	15	15	15	15	15	15	20	30	40	50	60	80	100	125	125	

In case of 1-phase use in series as shown below

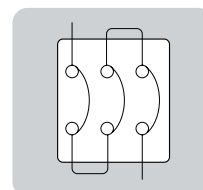

everything in control
www.tlauk.net

- connect it
- switch it
- control it
- automate it
- enclose it

Type '2' coordination according to IEC60947-4-1

- Short-circuit current $I_q = 50\text{kA}$
Voltage : 400/415V, 50/60Hz

Standard motors AC-3 at 400/415V 1500rpm		Manual motor starter			Contactor	
		Circuit breaker	Thermal overload release setting range	Magnetic release response current		
[kW]	[A]	Type	[A]	[A]	Type	[A]
-	-	MMS-32S 0.16A	0.1~0.16	2.1	GMC-6M / MC-9a / MC-9b	6 / 9
0.06	0.2	MMS-32S 0.25A	0.16~0.25	3.3	GMC-6M / MC-9a / MC-9b	6 / 9
0.09	0.3	MMS-32S 0.4A	0.25~0.4	5.2	GMC-6M / MC-9a / MC-9b	6 / 9
0.12	0.4	MMS-32S 0.63A	0.4~0.63	8.2	GMC-6M / MC-9a / MC-9b	6 / 9
0.18	0.6	MMS-32S 1A	0.63~1	13	GMC-6M / MC-9a / MC-9b	6 / 9
0.25	0.8	MMS-32S 1A	0.63~1	13	GMC-6M / MC-9a / MC-9b	6 / 9
0.37	1.1	MMS-32S 1.6A	1~1.6	20.8	GMC-6M / MC-9a / MC-9b	6 / 9
0.55	1.5	MMS-32S 1.6A	1~1.6	20.8	GMC-6M / MC-9a / MC-9b	6 / 9
0.75	1.9	MMS-32S 2.5A	1.6~2.5	32.5	MC-12a / MC-12b	12
1.1	2.7	MMS-32S 4A	2.5~4	52	MC-18a / MC-18b	18
1.5	3.6	MMS-32S 4A	2.5~4	52	MC-18a / MC-18b	18
2.2	5.2	MMS-32S 6A	4~6	78	MC-18a / MC-18b	18
3	6.8	MMS-32S 8A	5~8	104	MC-18a / MC-18b	18
4	9	MMS-32S 10A	6~10	130	MC-18a / MC-18b	18
5.5	11.5	MMS-32H 13A	9~13	169	MC-22b	22
7.5	15.5	MMS-32H 17A	11~17	221	MC-22b	22
10	20	MMS-32H 22A	14~22	286	MC-32a	32
11	22	MMS-32H 26A	18~26	338	MC-32a	32
15	29	MMS-32H 32A	22~32	416	MC-32a	32
18.5	35	MMS-63H 40A	28~40	520	MC-40a	40
22	41	MMS-63H 50A	34~50	650	MC-50a	50
30	55	MMS-63H 63A	45~63	819	MC-65a	65
37	67	MMS-100S 75A	55~75	975	MC-75a	75
-	-	MMS-100S 90A	70~90	1170	MC-85a	85
45	80	MMS-100S 100A	80~100	1300	MC-85a	85

Definition type '2' coordination according to IEC 60947-4-1 :

- The contactor or the starter must not endanger persons or systems in the event of a short-circuit.
- The contactor or the starter must be suitable for further use.
- No damage to the overload relay or other parts may occur with the exception of welding of the contactor or starter contacts provided that these can be easily separated without significant deformation (such as with a screwdriver).

Manual Motor Starters

Technical Information

IE3-rated motor

• LS MMS ready for IE3-rated motors

Type	Rated Current(A)	Short-circuit Current(A)	Current Range(A)			Short-circuit Current ratio		
			Min	Mid	Max	Min	Mid	Max
32	0.16A	2.1	0.1	0.13	0.16	20.8	16.0	13.0
	0.25A	3.3	0.16	0.2	0.25	20.3	16.3	13.0
	0.4A	5.2	0.25	0.33	0.4	20.8	15.8	13.0
	0.63A	8.2	0.4	0.52	0.63	20.5	15.8	13.0
	1A	13.0	0.63	0.81	1	20.6	16.0	13.0
	1.6A	20.8	1	1.3	1.6	20.8	16.0	13.0
	2.5A	32.5	1.6	2.1	2.5	20.3	15.5	13.0
	4A	52	2.5	3.3	4	20.8	15.8	13.0
	6A	78	4	5	6	19.5	15.6	13.0
	8A	104	5	6.5	8	20.8	16.0	13.0
	10A	130	6	8	10	21.7	16.3	13.0
	13A	169	9	11	13	18.8	15.4	13.0
	17A	221	11	14	17	20.1	15.8	13.0
	22A	286	14	18	22	20.4	15.9	13.0
	26A	338	18	22	26	18.8	15.4	13.0
	32A	416	22	27	32	18.9	15.4	13.0
40A	520	28	34	40	18.6	15.3	13.0	
63	10A	130	6	8	10	21.7	16.3	13.0
	13A	169	9	11	13	18.8	15.4	13.0
	17A	221	11	14	17	20.1	15.8	13.0
	22A	286	14	17	22	20.4	16.8	13.0
	26A	338	18	22	26	18.8	15.4	13.0
	32A	416	22	27	32	18.9	15.4	13.0
	40A	520	28	34	40	18.6	15.3	13.0
	50A	650	34	42	50	19.1	15.5	13.0
	63A	819	45	54	63	18.2	15.2	13.0
	65A	845	47	56	65	18.0	15.1	13.0
100	17A	221	11	14	17	20.1	15.8	13.0
	22A	286	14	18	22	20.4	15.9	13.0
	26A	338	18	22	26	18.8	15.4	13.0
	32A	416	22	27	32	18.9	15.4	13.0
	40A	520	28	34	40	18.6	15.3	13.0
	50A	650	34	42	50	19.1	15.5	13.0
	63A	819	45	54	63	18.2	15.2	13.0
	75A	975	55	65	75	17.7	15.0	13.0
	90A	1170	70	80	90	16.7	14.6	13.0
	100A	1300	80	90	100	16.3	14.4	13.0



• What is the IE3?

Motor is rated from IE1 through IE4 depends on its energy efficiency which means IE3 is more efficient compared to IE1 and IE2-rated motors.

• Why IE3?

As part of the EU Environmental policy "20/30-20-20" strategy, the EU is committed to achieve the followings by 2020.

- Reduce greenhouse gas emissions by up to 30 %
- Increase the share of renewable energy to 20 % and
- Boost energy efficiency by 20% in general.

IEC 60034-30 standard specifies IE classes for motors in accordance with the above requirements.

Therefore, consumers must comply with the standard when using MMS products.

- IEC 60034-30-1 standard
- IE1 Standard Efficiency
- IE2 High Efficiency
- **IE3 Premium Efficiency**
- IE4 Super Premium Efficiency

• How to select MMS?

To meet the IE3 motor starting current & Inrush current, use of de-rating table is recommended. (13 times the rated current)

Example)

If you select the product A or B...

A : MMS setting scale " 11 ~ 17A

B : MMS setting scale " 14 ~ 22A

Rated motor Current : 16A

The short-circuit current of MMS A is 221A (17*13), and MMS B is 286A (22*13).

When applying the motor's rated current(16A) to MMS A, the multiplier of the short-circuit current is 13.8 times. When applying the motor's rated current(16A) to MMS B, the multiplier of the short-circuit current is 17.9 times. If motor of IE3-grade or above is used here, malfunction can be caused due to higher starting current compared to that of IE1,2-graded motor. Therefore, MMS B is recommended since it has the higher multiplier of the short-circuit current.



Technical Information

Thermal limit on short circuit for MMS

Thermal limit in kA^2s in the magnetic operating zone ($U_e=415\text{V}$)

●MMS-32S

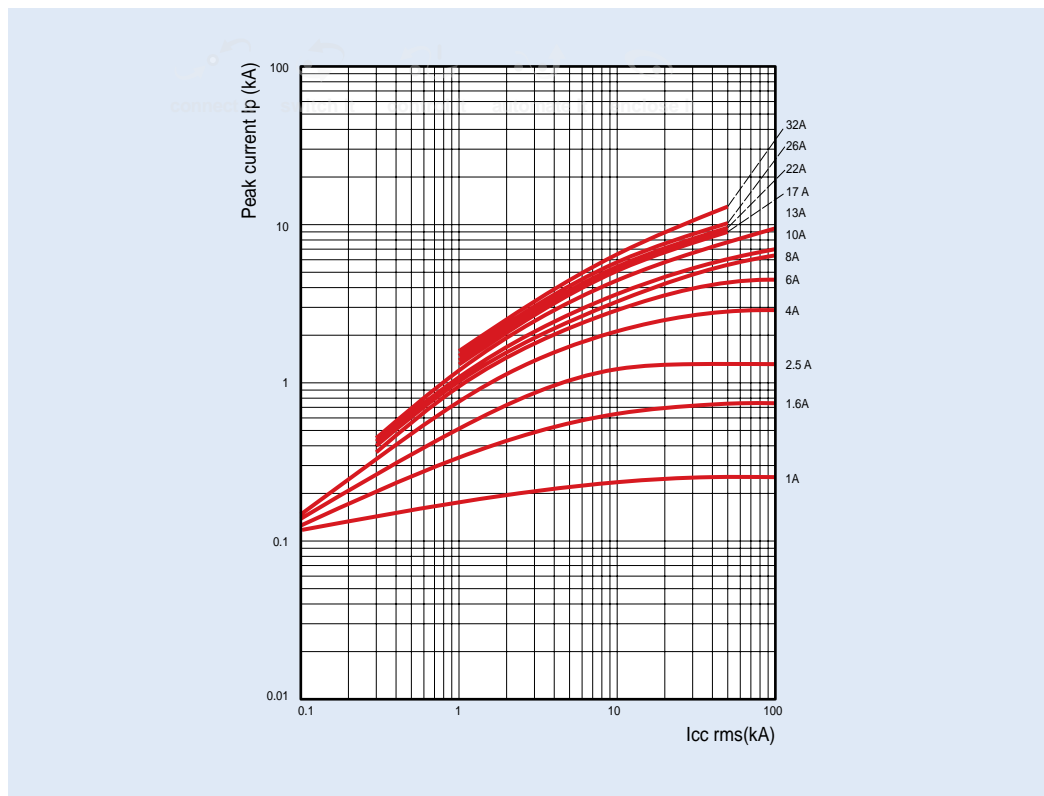
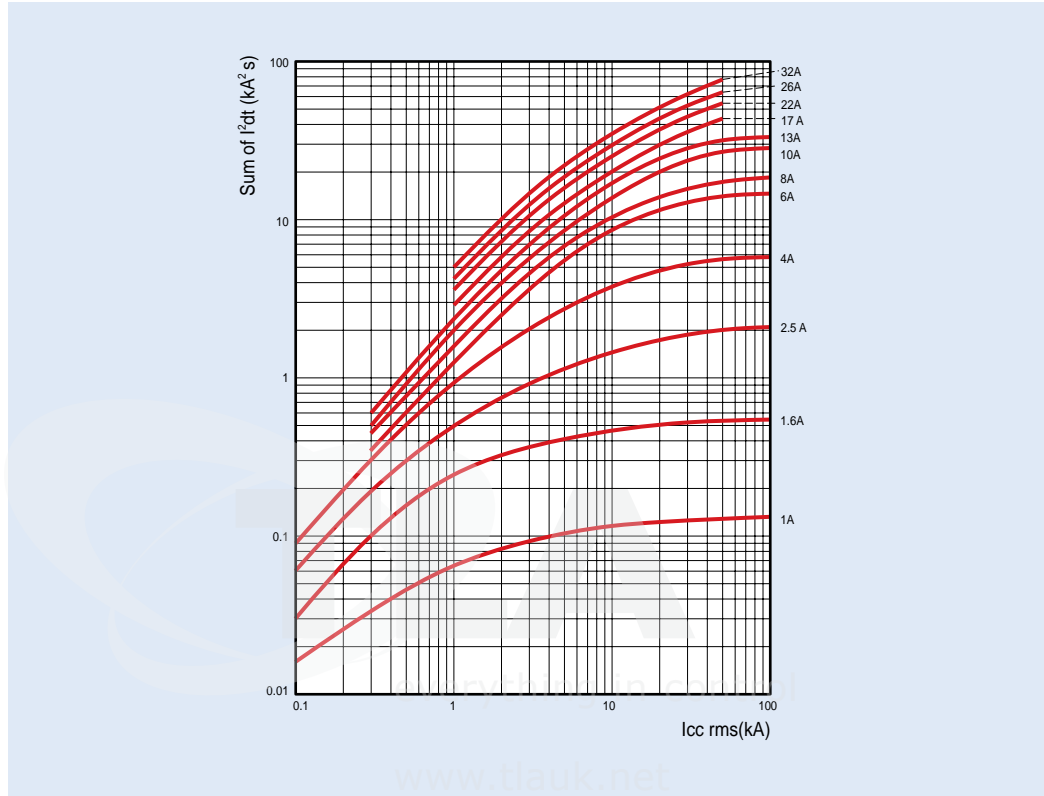

Manual Motor Starters

Technical Information

Thermal limit on short circuit for MMS

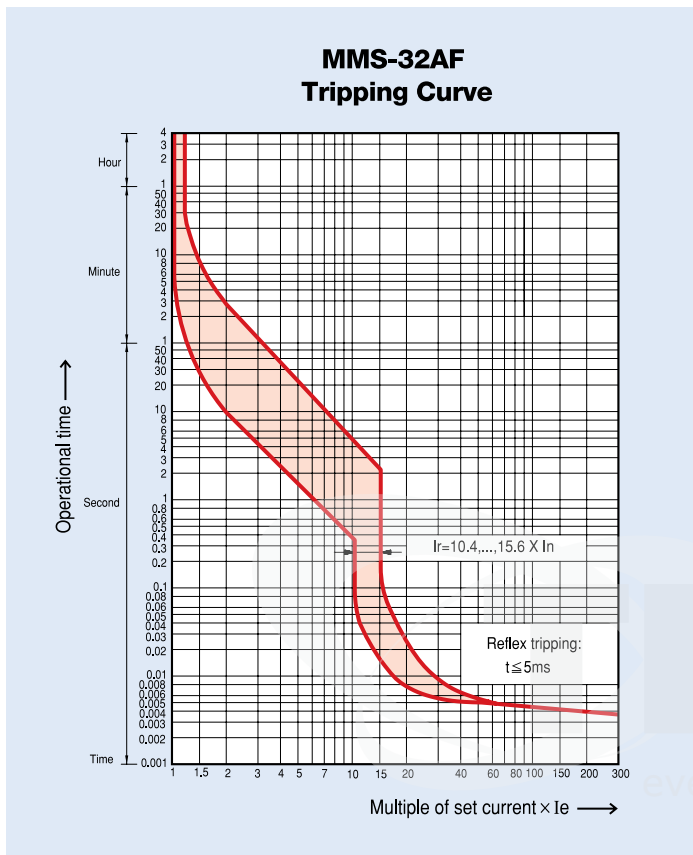

I) Thermal release trip current :

The adjustable inverse bimetal trip reliability protects motors against overloads.

The curve shows the mean operating current at an ambient temperature of 20°C starting from cold.

Careful testing and setting ensures effective motor protection even in the case of single-phasing.

II) Magnetic release trip current :

The instantaneous magnetic trip has a fixed operating current setting.

This corresponds to 13 times the maximum value of setting range,

at a lower setting it is correspondingly higher.

Current setting I_e :

The overload trip corresponds to a thermal overload relay in a motor starter conforming to IEC 947-4-1.

If a different value is prescribed (e.g. reduced I_e for cooling medium having a temperature higher

than 40°C or a place of installation higher than 2000m above sea level),

the setting current is equal to the reduced rated current I_e of the motor.

Manual Motor Starters

Technical Information

Dimension

• MMS 32S

[mm]

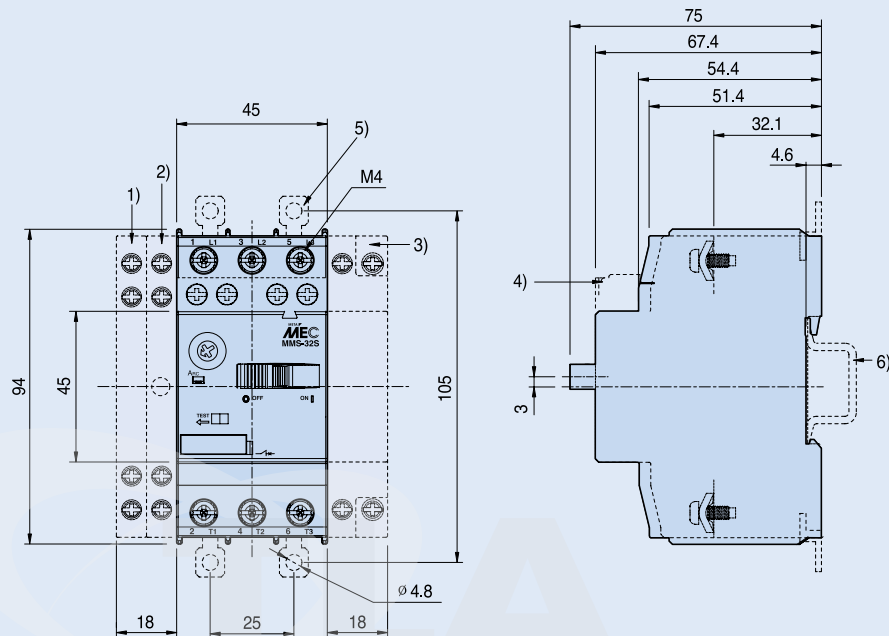

0.32kg

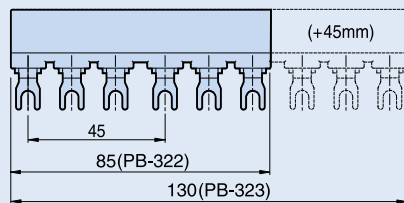
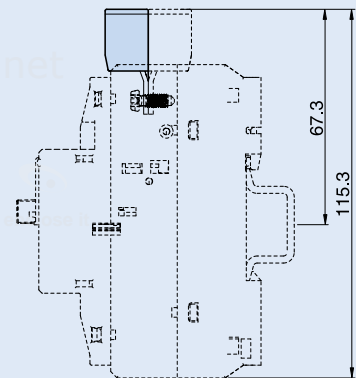
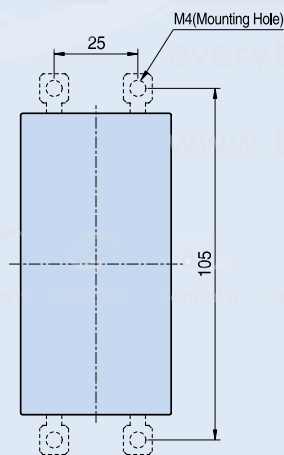

MMS-32S+PB-32(2, 3 Terminal)
PB-322(2 Terminal), PB-323(3 Terminal)
PB-324(4 Terminal), PB-325(5 Terminal)

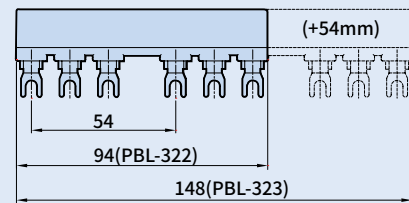

MMS-32S+PBL-32(2,3 Terminal)
PBL-322(2 Terminal), PBL-323(3 Terminal)

- 1) Side auxiliary switch
- 2) Side magnetic trip alarm switch
- 3) Side shunt release or Side undervoltage release
- 4) Front auxiliary switch
- 5) Push-in Lugs for screw mounting
- 6) 35mm standard mounting rail acc. to EN 50 022

Manual Motor Starters

Technical Information

Dimension

• MMS + Mini-MS

[mm]

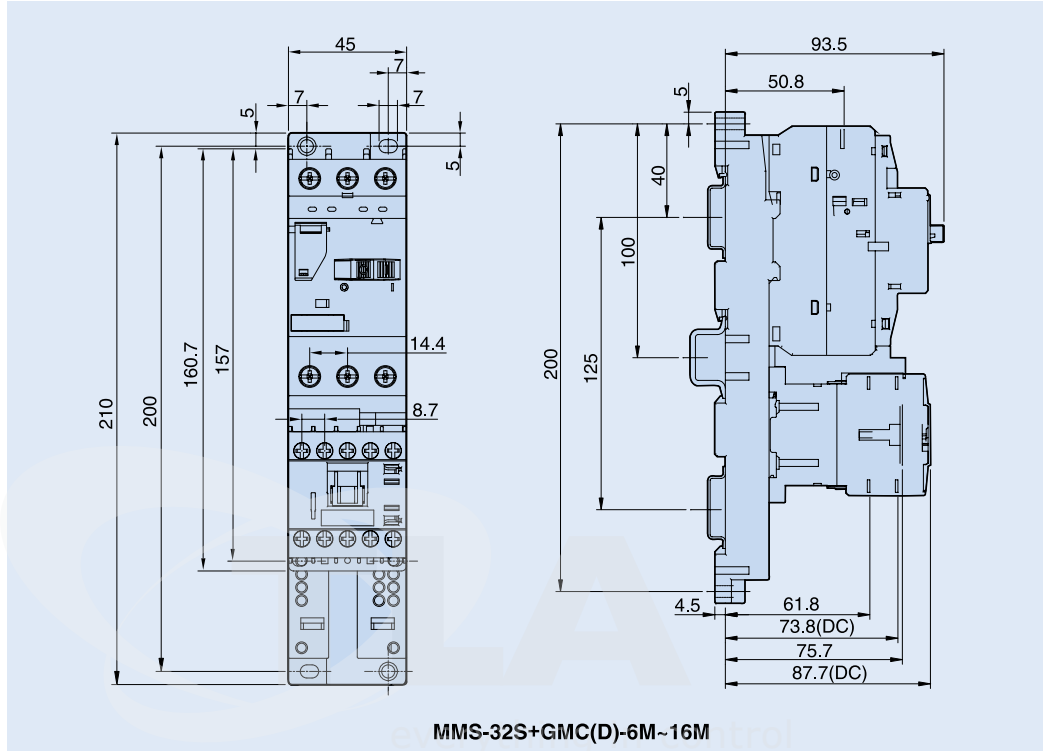

MMS-32S+GMC(D)-6M-16M

www.tlauk.net



connect it



switch it



control it



automate it



enclose it

Manual Motor Starters

Technical Information

Dimension

• MMS + Susol MC

[mm]

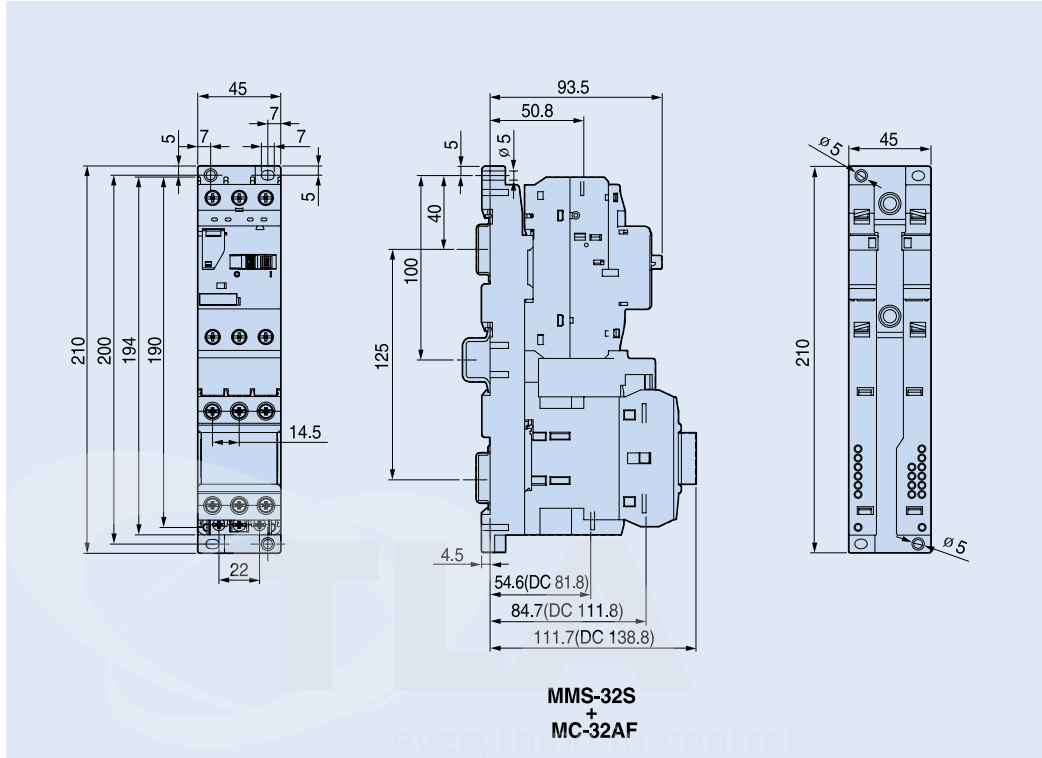

www.tlauk.net

connect it switch it control it automate it enclose it

Manual Motor Starters

Technical Information

Dimension

● Phase Bus

