

# OPS1050.1

## 1 General information

The OPS1050.1 is a DIN-rail-mountable power supply unit with basic functions. The output power is 120 W at 24 V with 5 A.

The wide-range input and international certification package make it suitable for use anywhere in the world. It is extremely reliable, with a MTBF of 500,000 hours. The units can be connected in parallel to increase capacity or provide redundancy.

Other beneficial features include an informative set of LED indicators and a double plus/minus terminal block for fast potential distribution. A third minus terminal block simplifies grounding on the secondary side. The unit is idle-proof, short-circuit-proof and provides regulated, adjustable output voltage.

- 100 to 240 VAC wide-range input
- High dielectric strength
- Can be connected in parallel for increased capacity and redundancy
- Reliable operation due to long power failure bypass function under full load and high MTBF (>500,000 h)
- International certification package
- Wide temperature range from -25 to 70°C
- Slender design
- Closed metal housing

## 2 Organization of safety notices

The safety notices in this data sheet are organized as follows:

Safety notice	Description
<b>Danger!</b>	Disregarding safety guidelines and notices can be life-threatening.
<b>Warning!</b>	Disregarding safety guidelines and notices can result in severe injury or substantial damage to equipment.
<b>Caution!</b>	Disregarding safety guidelines and notices can result in injury or damage to equipment.
<b>Information:</b>	Important information for preventing errors.

Table 1: Description of the safety notices used in this documentation

## 3 Order data

Model number	Short description	Figure
OPS1050.1	24 VDC power supply, 1-phase, 5 A, input 100 to 240 VAC, wide range, top-hat rail installation	

Table 2: OPS1050.1 - Order data

## 4 Technical data

Model number	OPS1050.1
<b>General information</b>	
Status display	Green LED (DC OK), threshold value $U_{out} = 21.5\text{ V}$
<b>Insulation voltages</b>	
Input - Output	4 kV AC (type test) 2 kV AC (routine test)
Input - Ground	2 kV AC (type test) 2 kV AC (routine test)
Output - Ground	500 VDC (type test)
Connection type	Screw terminal
<b>Connection cross section</b>	
Wire end sleeves	Flexible cables require wire end sleeves in order to fulfill EN 62368 / UL 60950
Flexible	0.2 to 2.5 mm <sup>2</sup> / 24 to 14 AWG
Inflexible	0.2 to 2.5 mm <sup>2</sup> / 24 to 14 AWG
Wire stripping length	9 mm (input/output)
<b>Certifications</b>	
CE	Yes
UL	cULus E123528 Industrial control equipment
<b>Input</b>	
Nominal input voltage	100 to 240 VAC
Input voltage	AC 85 to 264 V (wide range), 45 to 65 Hz
Input current	Approx. 1.65 A (120 VAC) Approx. 0.9 A (230 VAC)
Inrush current limiting	<15 A
$I^2t$	1.1 A <sup>2</sup> s
Power failure bypass	>20 ms (120 VAC) >110 ms (230 VAC)
Switch-on time	<1 s
Power factor (cos $\phi$ )	0.72
Leakage current to PE	<3.5 mA
Protective circuit	Transient surge protection with varistor
Internal fuse	3.15 A slow-blow
Required line fuse for line protection	6 A 10 A 16 A (characteristic B)
<b>Output</b>	
Nominal voltage	24 VDC $\pm 1\%$
Output power	120 W
Setting range for output voltage	22.5 to 29.5 VDC
Output current	
-25 to 55°C	5 A
>55°C	Derating: 2.5% per °C
Current limiting	Approx. 10 A (for short circuit)
Control deviation	<1% (static load change 10 to 90%) <2% (dynamic load change 10 to 90%) <0.1% (input voltage change $\pm 10\%$ )
Rise time	<2 ms ( $U_{out}$ (10 to 90%))
Residual ripple	<20 mV <sub>SS</sub>
Switching peaks	<30 mV <sub>SS</sub>
Can be connected in parallel	Yes, to establish redundancy and increase capacity
Can be connected in series	Yes
Max. capacitive load	Unlimited
Protection against internal overvoltages	Yes, limited to <35 VDC
Protection functions	Output protected against continuous short circuit, open circuit and overload
Power back immunity	Max. 35 VDC
Output noise suppression	Device complies with EN 55011 (class B)
<b>Efficiency, reliability</b>	
Efficiency	>89%
MTBF	>500,000 h, per IEC 61709 (SN 29500)
<b>Power dissipation</b>	
Rated load	Max. 18 W
No-load operation	Max. 1.1 W
<b>Operating conditions</b>	
<b>Mounting orientation</b>	
Horizontal	Yes
Vertical	No
<b>Installation elevation above sea level</b>	
Maximum	4000 m
Ventilation/Cooling	Normal convection, no fan required
Degree of protection per EN 60529	IP20

Table 3: OPS1050.1 - Technical data

<b>Model number</b>	<b>OPS1050.1</b>
<b>Ambient conditions</b>	
Temperature	
Operation	-25 to 70°C (>55°C derating)
Storage	-40 to 85°C
Transport	-40 to 85°C
Relative humidity	
Operation	Max. 95%, non-condensing
Vibration	
Operation	<15 Hz, amplitude ±2.5 mm, per IEC 60068-2-6 15 to 150 Hz, 2.3 g, 90 min
Shock	
Operation	15 g in each direction, per IEC 60068-2-27
Pollution degree	2, per EN 50178
Climate category	3K3, per EN 60721
<b>Mechanical properties</b>	
Housing	
Material	Steel sheet, galvanized Side panels: Aluminum
Installation	Easy top-hat rail installation (NS 35 rails, EN 60715)
Dimensions	
Width	40 mm
Height	130 mm
Depth	115 mm
Weight	600 g

Table 3: OPS1050.1 - Technical data

## 5 Standards and conformity

### Standards

Electrical equipment of machines	EN 60204 / Overvoltage category III
Safety isolating transformers for switching power supplies	EN 61558-2-17
Electrical security (for IT equipment)	EN 62368 / VDE 0805 (SELV) EN 61558-2-17
Shipbuilding	Germanischer Lloyd
Electronic equipment for high voltage systems	EN 50178 / VDE 0160 (PELV)
Safety extra low voltage	EN 62368 (SELV) EN 60204 (PELV)
Safe isolation	DIN VDE 0100-410 DIN VDE 0106-1010
Protection against electrical shock	DIN 57100-410
Protection against shock current, basic requirements for safe isolation in electrical equipment	DIN VDE 0106-101
Harmonic current emission limits	EN 61000-3-2

### Conformity to EMC directive 89/336/EWG

Immunity to disturbances EN 61000-6-2		
Electrostatic discharge		
	EN 61000-4-2	
	Housing	Level 3
	Contact discharge	8 kV
	Air discharge	8 kV
	Comment	Criteria B <sup>1)</sup>
Electromagnetic HF field		
	EN 61000-4-3	
	Housing	Level 3
	Frequency range	80 MHz to 3 GHz
	Field strength	10 V/m
	Comment	Criteria A <sup>2)</sup>
Burst		
	EN 61000-4-4	
	Input	4 kV (Level 4 - asymmetrical: line to GND)
	Output	2 kV (Level 3 - asymmetrical: line to GND)
	Comment	Criteria B <sup>1)</sup>
Surge		
	EN 61000-4-5	
	Input	4 kV (asymmetric: line to GND) 2 kV (symmetric: line to line)
	Output	2 kV (Level 3 - asymmetrical: line to GND) 1 kV (Level 3 - symmetrical: line to line)
	Comment	Criteria B <sup>1)</sup>
Conducted interference		
	EN 61000-4-6	
	Input / output	Level 3 - asymmetrical
	Frequency range	10 kHz to 80 MHz
	Voltage	10 V
	Comment	Criteria A <sup>2)</sup>
Voltage dips		
	EN 61000-4-11	
	Input	(Power failure bypass >10 ms)
	Comment	Criteria B <sup>1)</sup>

- 1 **Criteria B:** Temporary adverse effects on the operating characteristics that the device corrects automatically
- 2 **Criteria A:** Normal operating behavior within defined limits

Emissions in accordance with EN 61000-6-3	
RFI voltage EN 55011	EN 55011 (EN 55022) Class B for industry and office/home
Radiated emissions in accordance with EN 55011	EN 55011 (EN 55022) Class B for industry and office/home

## 6 Block diagram

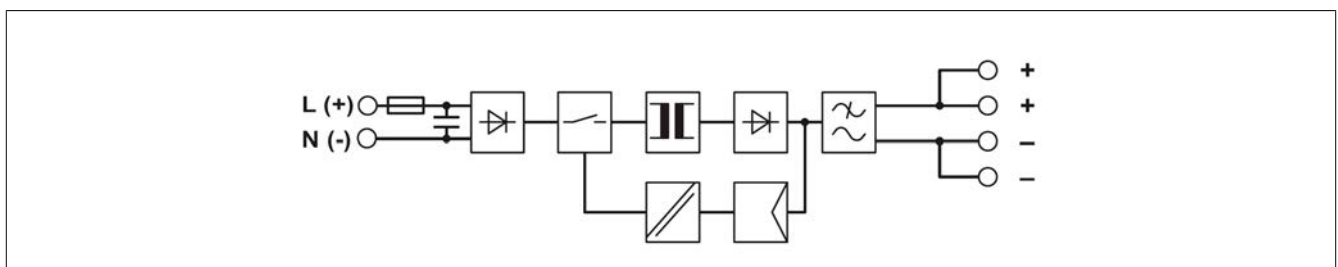

## 7 Signaling

The "DC OK" LED makes it possible to evaluate the functionality of the power supply directly on-site.

	State 1	State 2
"DC OK" LED	Lit	Off
Cause	Output voltage >21.5 V	Output voltage <21.5 V or no voltage at output
Meaning	Output voltage and output current are OK	<ul style="list-style-type: none"> <li>The unit is <b>operating</b>, but there is an error on the consumer, the current consumption is greater than <math>I_N</math> or there is a short circuit on the output.</li> <li>The unit is <b>not operating</b> because it is not receiving supply voltage, the primary fuse has tripped or the unit is defective.</li> </ul>

## 8 Characteristic curves

### Output characteristics

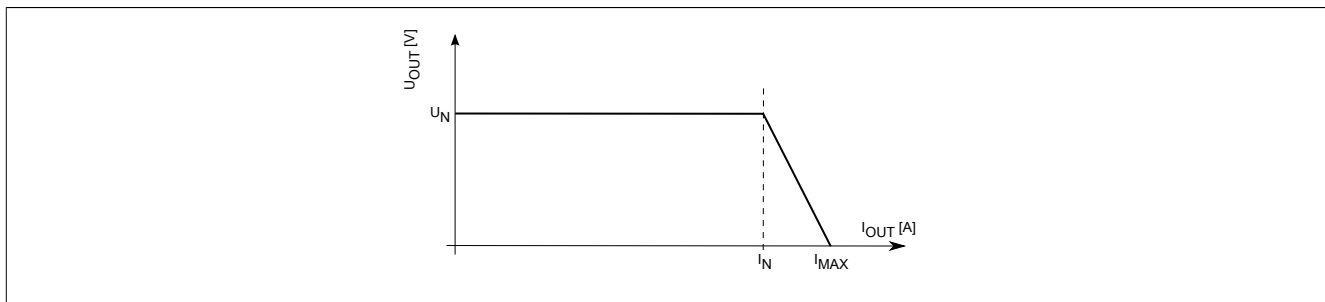

The unit operates according to the U/I characteristic curve. The operating point follows this curve when a load is applied. The output current is limited if a short circuit or overload occurs. Instead of switching off, the unit continues to provide a continuous output current.

The secondary voltage is lowered until the secondary short circuit or overload has been corrected. The U/I characteristic curve ensures that highly capacitive loads as well as consumers with DC/DC converters in the input circuit can be supplied. Downstream fuses are tripped reliably. Selectivity in the design of your system is thus guaranteed at all times.

$$\begin{aligned}
 U_N &= 24 \text{ V} \\
 I_N &= 5 \text{ A} \\
 P_N &= 120 \text{ W}
 \end{aligned}$$

### Temperature characteristics

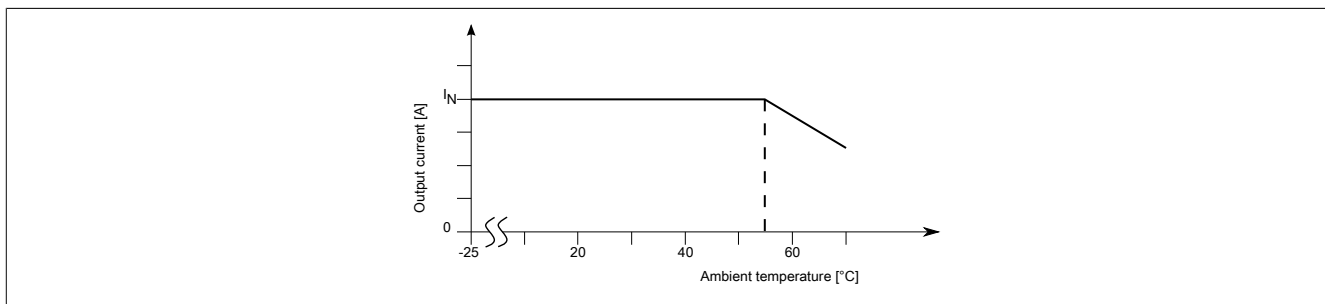

At an ambient temperature of 55°C, the unit provides a continuous output current of  $I_N$ . At ambient temperatures over 55°C, the output power must be derated by 2.5% per Kelvin.

At ambient temperatures over 70°C, the unit does not shut down. Instead, the output power is reduced enough to prevent damage. Once the unit cools down, the output power is increased again.

## 9 Safety notices

### Information:

Please note before commissioning:

The mains connection must be implemented properly and provide protection against electrical shock.

According to the regulations in EN 62368, it must be possible to switch the device to a voltage-free state outside the power supply (e.g. using line protection on the primary side)!

All lines must be sufficiently dimensioned and protected.

All output lines must be dimensioned to handle the maximum output current for the unit or special protective measures must be implemented.

Sufficient convection must be ensured!

The protective ground conductor must be connected!

### Caution!

The power supply units are built-in devices. They must be installed and commissioned by appropriately qualified personnel in adherence with local regulations.

### Danger!

The units contain components with life-threatening levels of voltage and large amounts of stored power!

Always ensure that the power is turned off before handling them.

Disconnect equipment from the power source and ensure that it is not located in a potentially explosive atmosphere before removing it.

Depending on the ambient temperature and the operating load, the housing may become very hot!

## 10 Layout

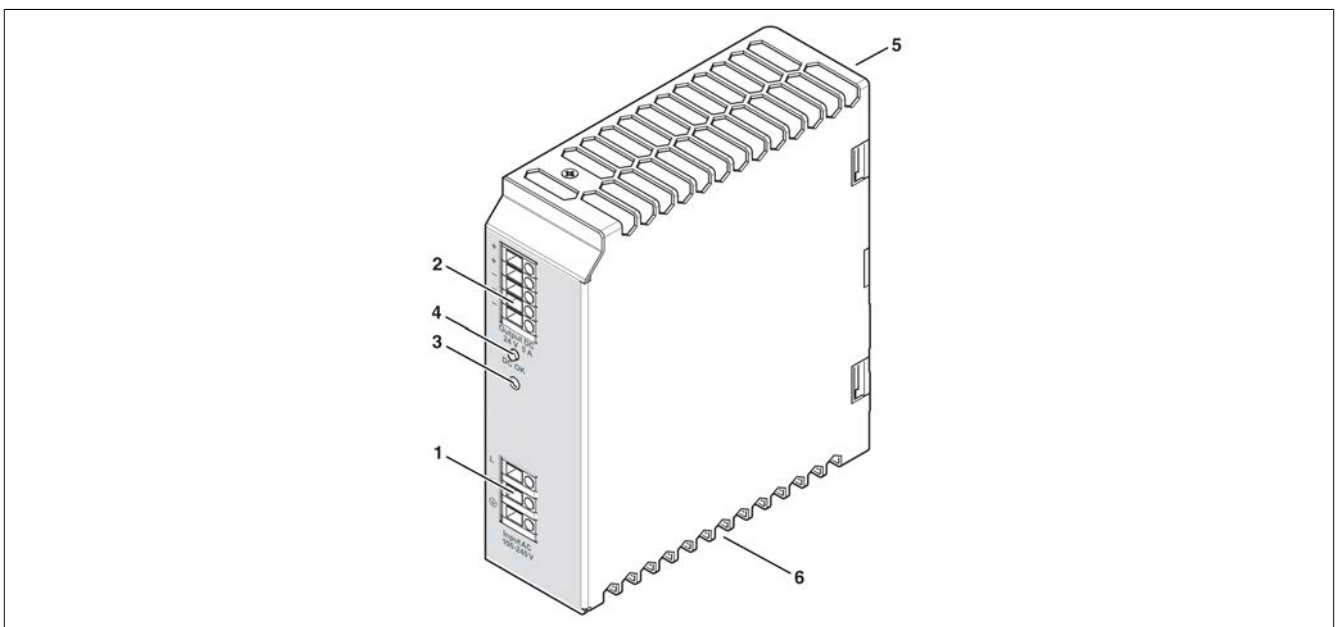

- 1) AC input
- 2) DC output
- 3) Potentiometer (22.5 to 29.5 VDC)
- 4) "DC OK" LED
- 5) Mounting rail adapter
- 6) Slot for cable tie

## 11 Input

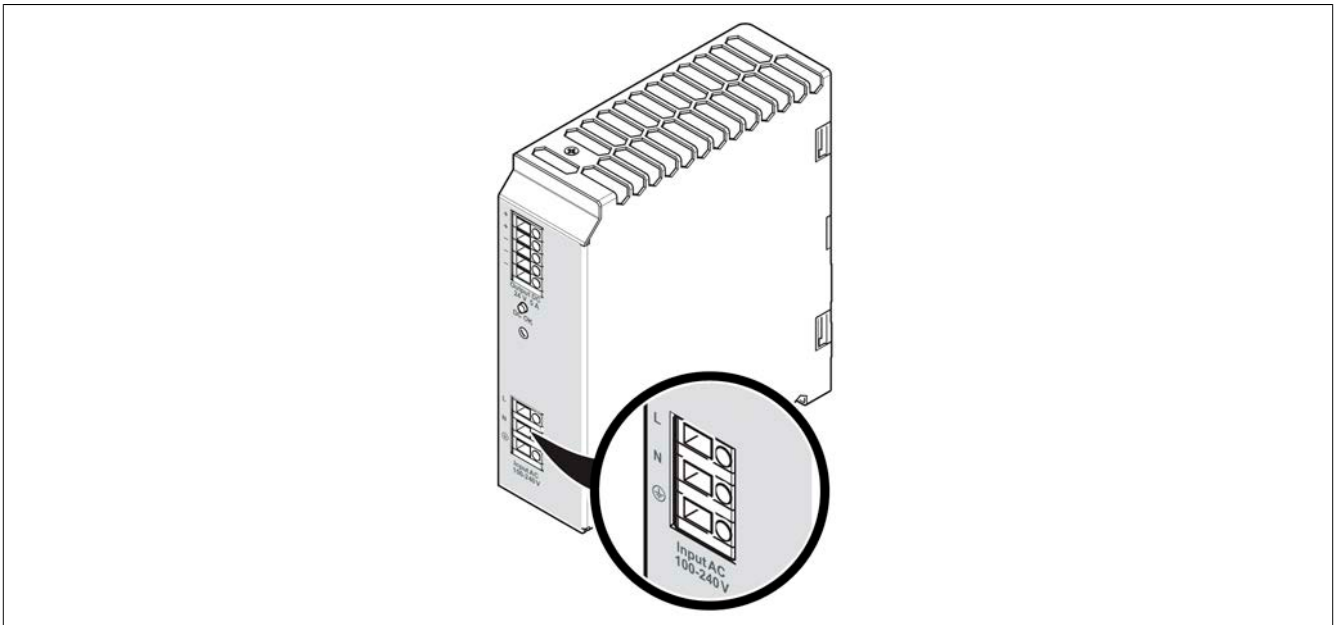

### Information:

If an internal fuse is tripped, it is very likely that the unit is defective. In this case it needs to be sent back to the factory to be checked.

### Protection on the primary side

The device must be installed in accordance with the regulations in EN 62368. It must be possible to switch the device to a voltage-free state outside the power supply using a suitable disconnect device. Line protection on the primary side is suitable for this purpose, for example.

The device is protected by an internal fuse. Additional device protection is not necessary.

### Required line fuse for line protection

6 A, 10 A or 16 A circuit breakers; Characteristic B (or functional equivalent)

## 12 Output

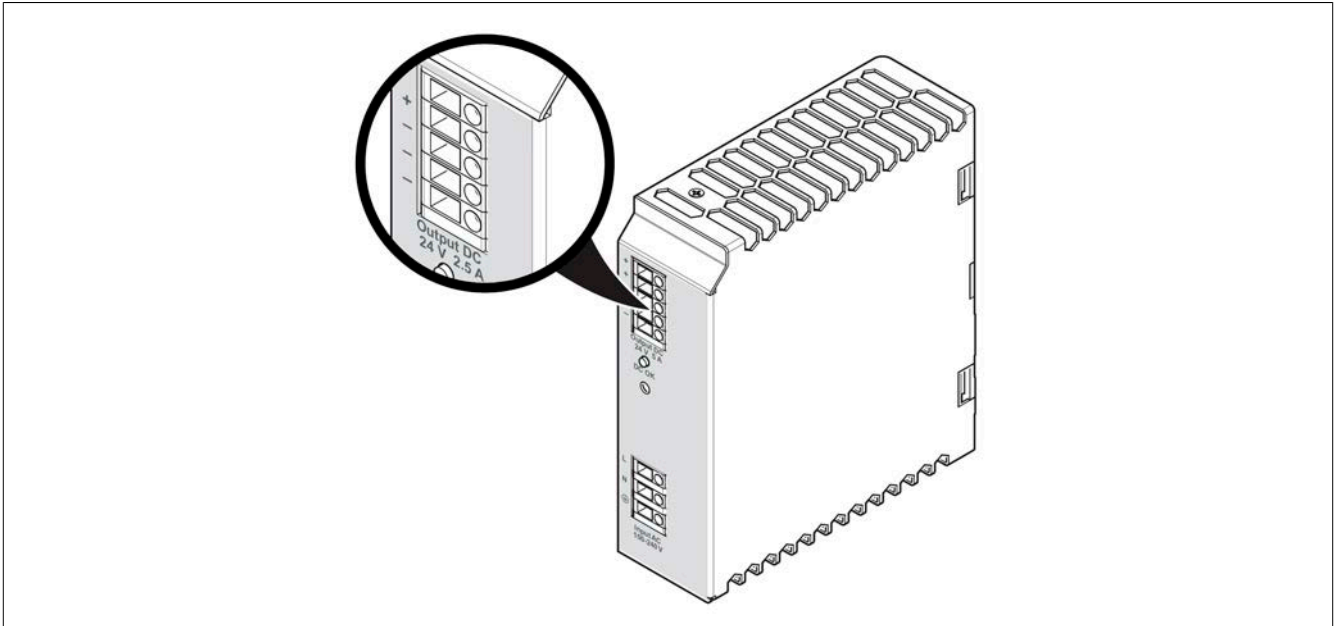

The connection is made via the "+" and "-" screw connectors on the DC output. The configured output voltage upon delivery is 24 VDC. The output voltage can be configured using the potentiometer.

### Protection on the secondary side

The device is electronically protected against short circuit and idling. When a fault occurs, the output voltage is limited to a maximum of 35 VDC.

#### Information:

**Make sure that all output lines are dimensioned to handle the maximum output current or that special protective measures have been implemented.**

**Secondary cables must have sufficiently large cross sections to keep voltage drops on the lines as small as possible.**

#### Information:

**Cable ties can be used to fasten the connection lines to the housing.**

**Make sure that the cable ties and connection lines are designed for the temperatures common to operation.**

**Make sure not to damage the insulation of the connection lines when applying the cable ties.**



## 13 Dimensions

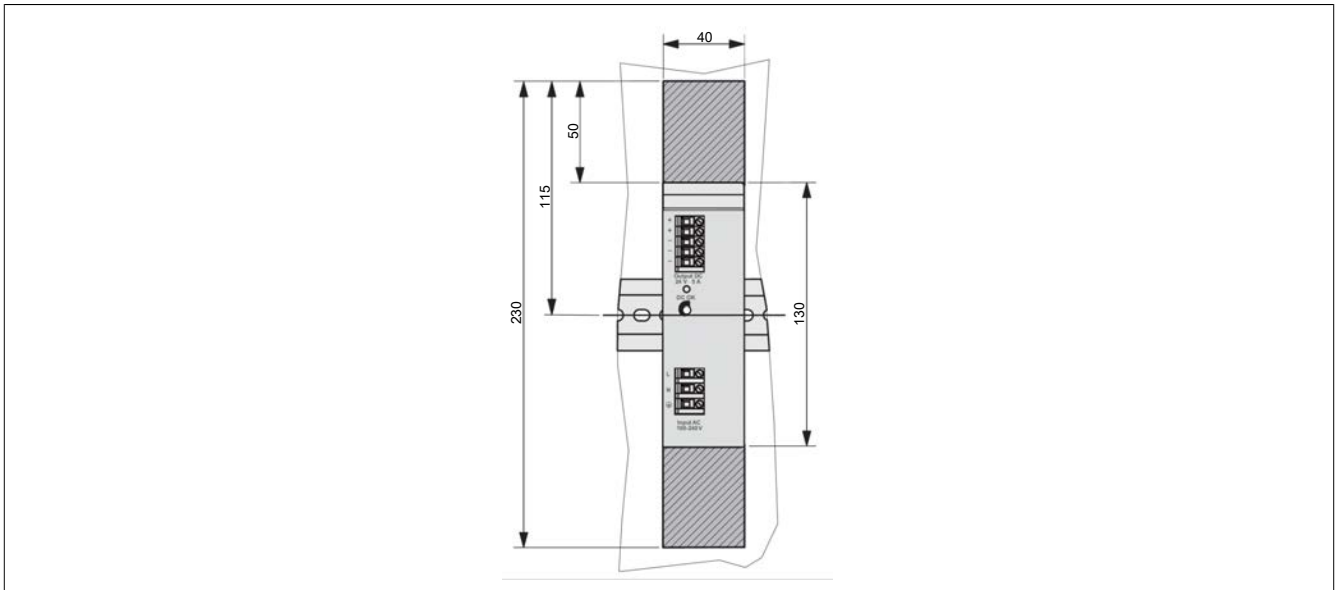

Installation depth 115 mm + DIN rail

## 14 Installation

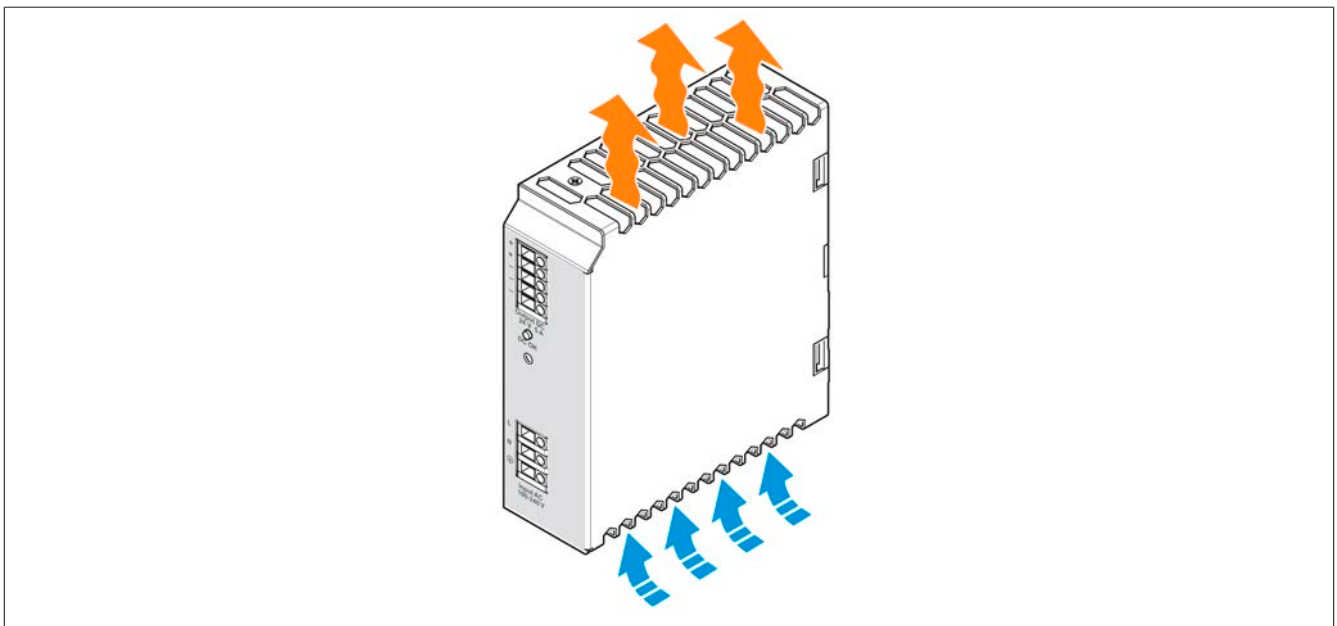

### Information:

To ensure sufficient convection, we recommend the following minimum spacing between modules: 5 cm vertically and 0 cm horizontally.

The DIN rail must be mounted horizontally with the ventilation slots facing up and down.

## 15 Mounting rail installation

The power supply unit can be snapped onto all 35 mm DIN rails in acc. with EN 60715.

### Mounting

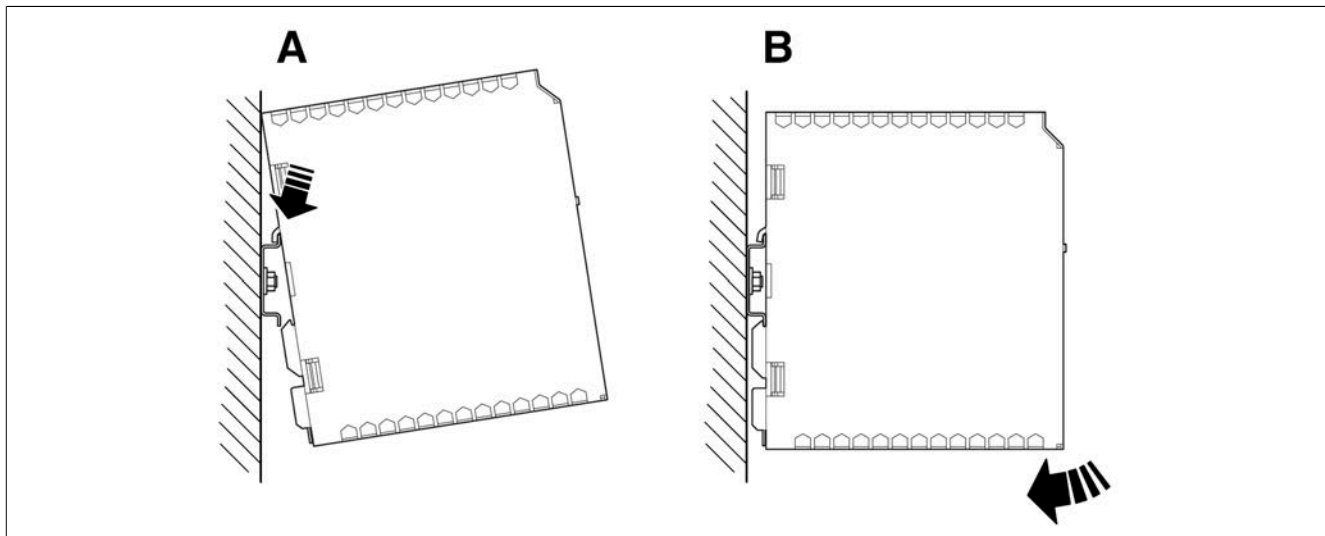

Position the module with the DIN rail guide on the **upper edge** of the DIN rail, and snap it in with a **downward** motion.

### Removal

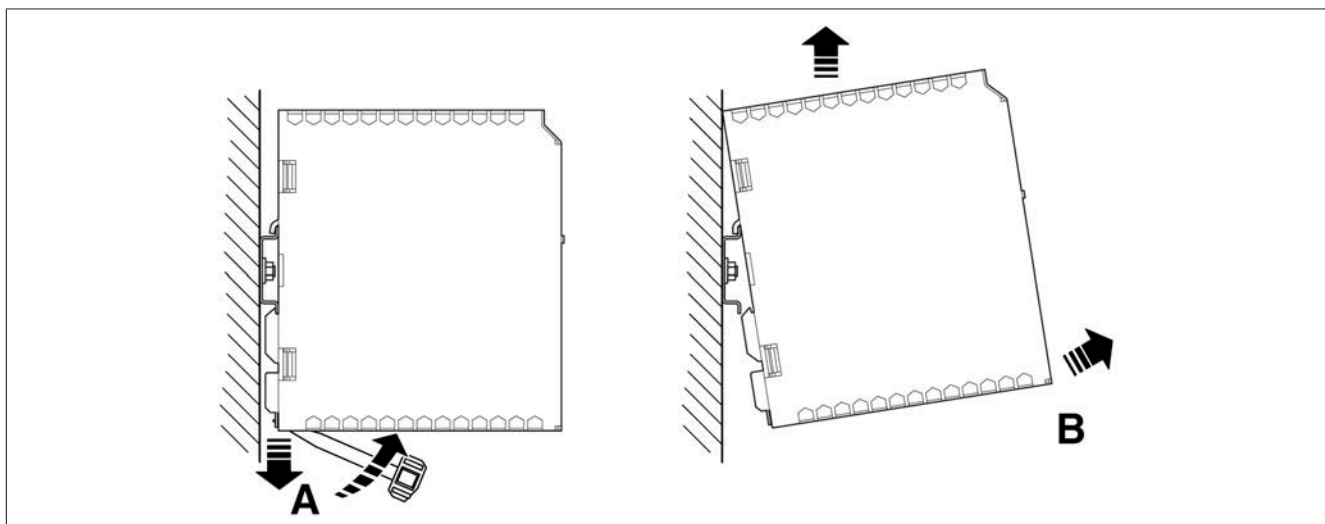

Pull the snap lever open with the aid of a screwdriver and slide the module out at the **lower edge** of the DIN rail.

## 16 Cable data

Type of connection: Screw clamp  
 Stripping length: 9 mm  
 Wire tip sleeves: 10 mm

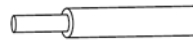

	[mm <sup>2</sup> ]		AWG	[Nm]
	Fixed	Flexibility		Torque
Input	0.2 - 2.5	0.2 - 2.5	24 - 14	0.4 - 0.5
Output	0.2 - 2.5	0.2 - 2.5	24 - 14	0.4 - 0.5

## 17 Connection to supply voltage

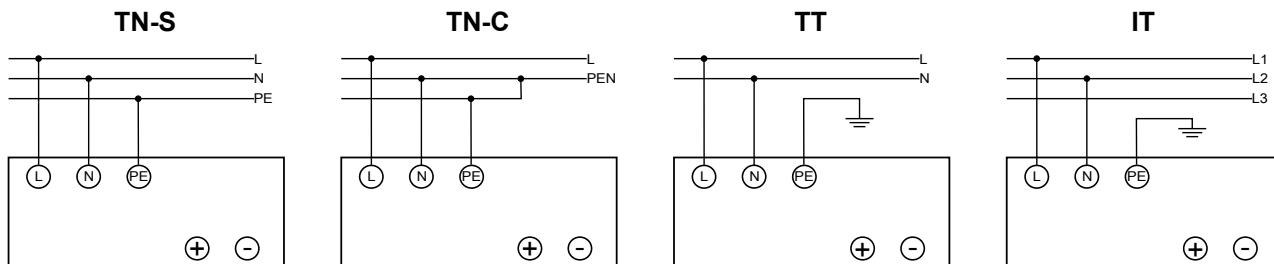

The 100 to 240 VAC connection is made using the L, N and PE screw connections.

The device can be connected to single-phase AC networks or to two phases of a three-phase network (TN, TT or IT systems in acc. with VDE 0100-300 / IEC 60364-3) with nominal voltages of 100 to 240 VAC.

At input voltages >300 VAC, the device switches itself off as a self-defense mechanism. Once the overvoltage has abated, the device automatically starts back up again within a few seconds.

An all-pole disconnection device is required when operating on two phases of a three phase network.

### Information:

**In order to comply with the UL certification, use copper cables that are designed for operating temperature of >75°C.**

**Flexible cables require wire end sleeves in order to comply with EN 62368 / UL 60950. For a reliable and touch-proof connection, strip the connection ends. For the required lengths, see the cable data table above.**

## 18 Parallel operation

Devices of the same type can be connected in parallel for redundancy and increased capacity. No further comparison is required in factory default state.

If the output voltage is adjusted, an even distribution of current is ensured by setting all power supplies connected in parallel to the exact same output voltage.

To ensure a symmetrical distribution of current, we recommend that all cable connections from the power supply unit to the DIN rail are the same length and have the same cross section.

Depending on the system, a protective circuit should be installed at each individual device output (e.g. decoupling diode or DC fuse) for the parallel connection of two or more power supplies. This prevents high return currents in the event of a secondary device fault.

### Redundant operation

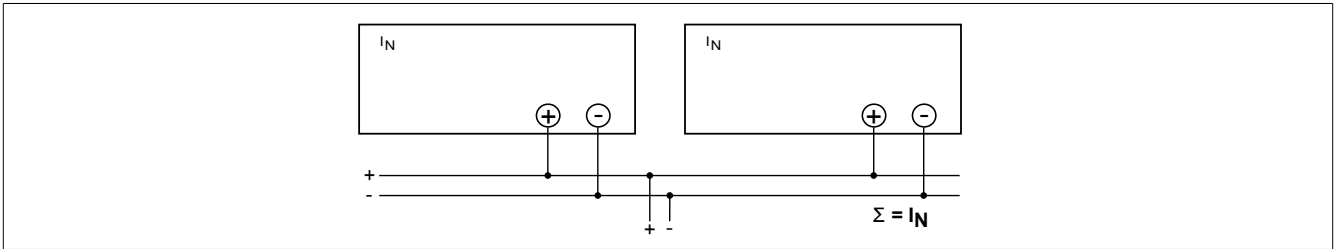

Redundant connections are designed for supplying systems with particularly high requirements on operational safety. If a fault occurs in the primary circuit of the first power supply unit, the second device automatically takes over the complete power supply without interruption, and vice versa.

For this purpose, the power supply units to be connected in parallel must be large enough that the total current requirements of all loads can be fully met by one power supply unit. External decoupling diodes are required for 100% redundancy!

### Increasing power

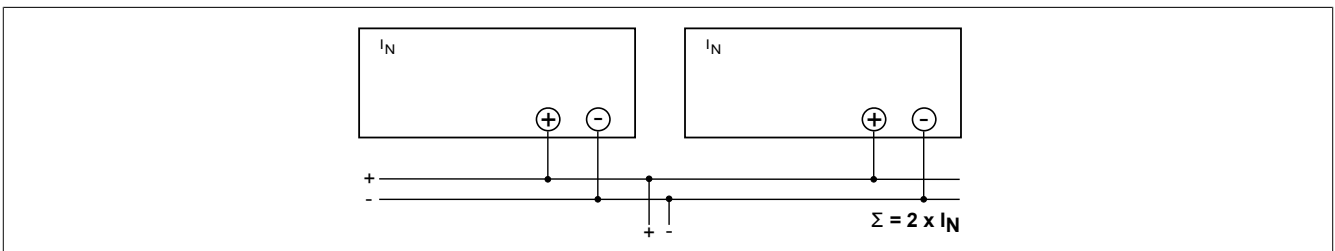

The output current can be increased to  $n \times I_N$  where  $n$  is the number of devices connected in parallel.

Parallel connection for increasing power is used when extending existing systems. A parallel connection is recommended if the power supply unit does not cover the current consumption of the most powerful load. Otherwise, the loads should be divided over separate individual devices.

### Information:

**A maximum of five devices can be connected in parallel!**

## 19 Forming DC bus capacitors

Electrolytic capacitors are installed in B&R servo drives, inverter modules, stepper motor modules and power supplies. In these cases, the oxide layer that acts as a dielectric can become weakened by electrochemical processes when stored for a lengthy period with the power is switched off. In the worst case, this can cause a short circuit and subsequent destruction of the capacitor and irreparable damage to B&R modules.

When stored for periods over 1 year, the electrolytic capacitors may be destroyed during commissioning if not preconditioned. If preconditioning takes place using a forming process defined for B&R modules, then proper operation can be guaranteed. Forming is performed by applying a defined voltage over a defined period of time. This reforms the oxide layer to ensure the functionality of the electrolytic capacitors.

### Caution!

**DC bus capacitors can become damaged or destroyed when switching on at the nominal voltage after being stored for periods over 1 year.**

**Forming B&R modules stored over a long period of time before commissioning avoids damage to the capacitors.**

### 19.1 Forming specifications for DC bus capacitors

#### Procedure for modules stored for a long period of time

If modules are not supplied with nominal voltage for a longer period of time, the DC bus capacitors must be formed as follows.

The nominal voltage is the voltage permitted at the mains connections on the respective module.

Power is only supplied to the module; the output stage or controller is NOT permitted to be switched on during this!

<b>Storage time up to 1 year:</b>	→ No action required
<b>Storage time 1 to 2 years:</b>	→ Supply the module with nominal voltage 1 hour before commissioning.
<b>Storage time 2 to 3 years:</b>	<p>Supply the module with an adjustable power supply and increase the voltage in steps. Observe the following sequence:</p> <ol style="list-style-type: none"> <li>1. Supply with 25% of the nominal voltage for 30 minutes.</li> <li>2. Supply with 50% of the nominal voltage for 30 minutes.</li> <li>3. Supply with 75% of the nominal voltage for 30 minutes.</li> <li>4. Supply with 100% of the nominal voltage for 30 minutes.</li> </ol> <p>Total forming time: &gt;2 hours The module is now ready for operation.</p>
<b>Storage time 3 or more years:</b>	<p>Supply the module with an adjustable power supply and increase the voltage in steps. Observe the following sequence:</p> <ol style="list-style-type: none"> <li>1. Supply with 25% of the nominal voltage for 2 hours.</li> <li>2. Supply with 50% of the nominal voltage for 2 hours.</li> <li>3. Supply with 75% of the nominal voltage for 2 hours.</li> <li>4. Supply with 100% of the nominal voltage for 2 hours.</li> </ol> <p>Total forming time: &gt;8 hours The module is now ready for operation.</p>

### Information:

**B&R recommends forming at nominal voltage for 1 hour once a year.**

**B&R modules that have been stored for more than 5 years without forming should no longer be put into operation.**

**The storage period is valid from the time of delivery by B&R.**